

ECOPHON

AKUSTO™

EXPLORING ACOUSTIC WALL SOLUTIONS



04 ABOUT ECOPHON

06 GOOD ACOUSTICS MATTER EVERYWHERE

08 TOWARDS NET-ZERO ACOUSTICS

10 EXPLORING ACOUSTIC WALL SOLUTIONS WITH ECOPHON AKUSTO™

12 ECOPHON AKUSTO™ PRODUCT RANGE

- 14 Akusto Wall A
- 16 Akusto Wall C
- 16 Akusto Wall C Extra Bass
- 18 Akusto Freedom
- 20 Akusto Triangle
- 22 Akusto Hexagon
- 22 Akusto One
- 23 Akusto Screen

24 INSTALLATION METHODS

26 ECOPHON AKUSTO™ OVERVIEW

28 COLOURS AND SURFACES

32 SYSTEM PROPERTIES

Acoustics, technical properties and installation diagrams

CONTACT US

Saint-Gobain Ecophon UK

Saint-Gobain Ecophon, Monk Sherborne Road,
Ramsdell, Tadley, RG26 5PP
www.ecophon.com/uk

Tel: 01256 850977 Fax: 01256 851550
E: info@ecophon.co.uk

Sales office, or order and stock information:

Tel: 01256 855220 Fax: 01256 850600
E: sales.office@ecophon.co.uk

Technical Support

Tel: 01256 855250
E: technical@ecophon.co.uk

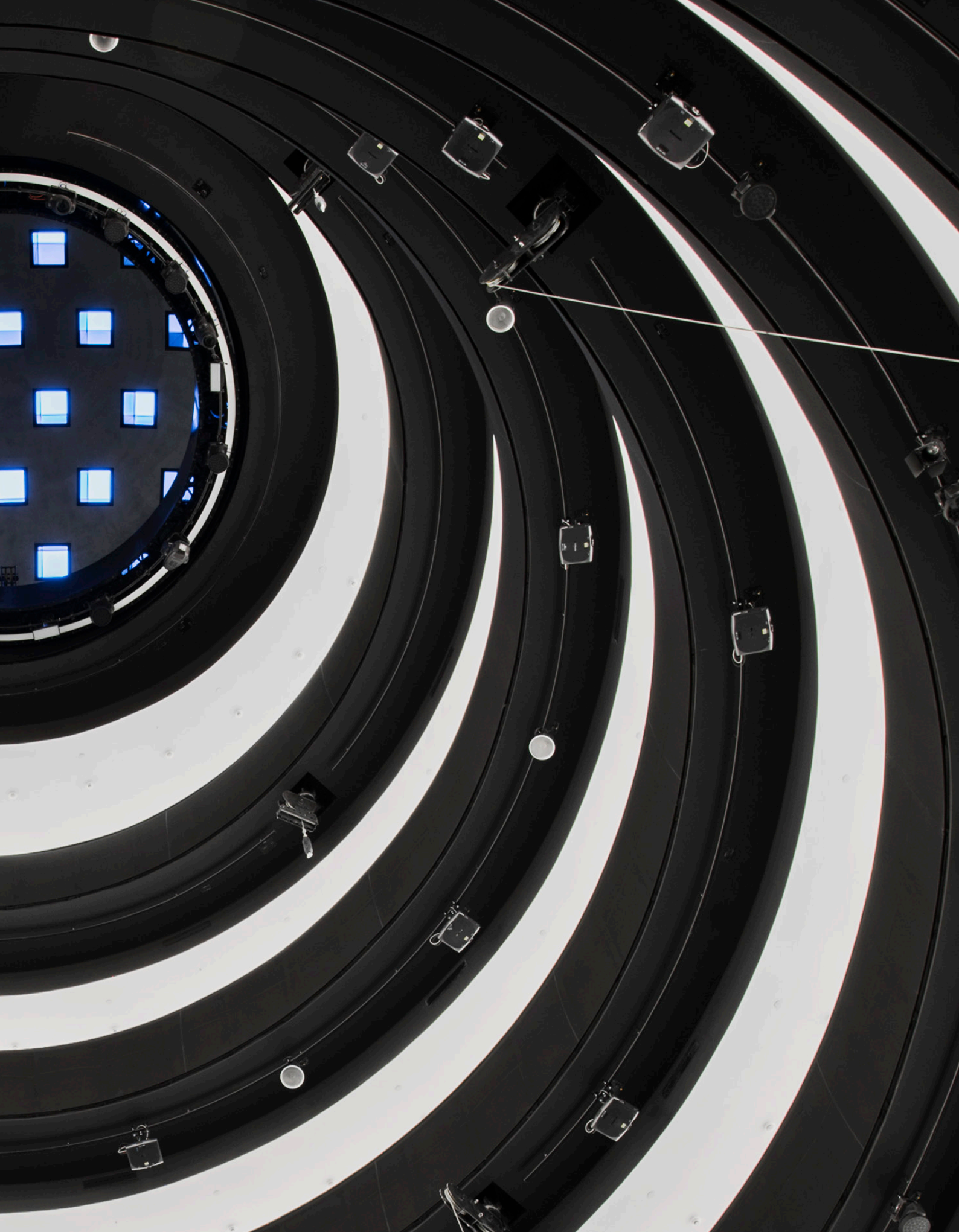



04





A SOUND EFFECT

ON PEOPLE

05

Saint-Gobain Ecophon contributes to good indoor environments for working, healing and learning. We do this by developing, manufacturing and delivering acoustic products and systems designed around the natural evolution of human hearing - replicating the outdoor sound experience indoors, because that's just better for people.

Having a sound effect on people, in every way we can, is what we do proudly. That promise makes every one of us a passionate advocate for the importance of room acoustics to people's wellbeing - whatever the space, activity or need.

GOOD ACOUSTICS MATTER EVERYWHERE

06

The importance of acoustics is underappreciated. Sound impacts us in daily life, and the scientific support for improving our indoor sound environments is well-documented.

And what exactly is an ideal indoor sound environment for people? One based on how we experience sound outside. The human auditory sense is naturally adapted to an outdoor environment where there is not any sound reflections from ceilings and walls.

That's why most of what we do at Ecophon is about replicating the acoustic qualities found in nature for indoor environments. We want to optimise indoor spaces to our natural way of hearing, so that speech and sound is easy to hear and understand, when needed, improving performance and wellbeing.

Usually that starts with the ceiling. A wall-to-wall acoustic ceiling is the easiest way to get a large sound-absorbing surface area into a space, and is usually the best way to reduce sound strength, shorten reverberation times, and increase speech clarity and overall hearing comfort.







TOWARDS

NET-ZERO ACOUSTICS

Sustainability is more than a word – it’s a collective movement to protect people, and the planet, that requires honest commitment and genuine care. That’s why Ecophon is building on better materials, transparency, and principles, to name just a few.

We actively support an industry-wide drive to standardised, easy-access Environmental Product Declarations for individual products, rather than product families. Their inclusion of full lifecycle data, from raw material sourcing to end of life, rather than only the favourable stages. A move away from self-declared labels, or non-independently verified sustainability claims. Any promises of net zero carbon emission targets to be validated by the Science-Based Targets initiative.

If we’re going to build a sustainable future, it has to start with an honest approach, high ambition and the best of intentions – to build on better together.



ECOPHON AKUSTO™

EXPLORING ACOUSTIC WALL SOLUTIONS

Ecophon Akusto™ is a complement to acoustic ceilings that solves acoustic challenges and allows opportunities to follow current design and installation trends. The panel surface is available in Texona, Super G and Akutex FT.

- Excellent acoustics
- Wall and screen absorbers with many installation solutions
- A vertical solution in a variety of surfaces, colours and shapes

When designing a space for optimal acoustic performance, a sound-absorbing ceiling is the first priority, but bare walls will still create echoes. Akusto panels will solve this by absorbing sound and give clearer speech, lower sound strength, reduce sound propagation and take away flutter echoes.

With Akusto, it is easy to create workplaces where people feel good and can perform at their very best.



*Akusto acoustic absorbers
has minimum*

48%

POST-CONSUMER
RECYCLED CONTENT



superior

FIRE PROPERTIES

EN 13501-1 and A2-s1, d0

ECOPHON AKUSTO™ PRODUCT RANGE

Akusto gives you many ways to individualise your acoustic solution in unique and expressive configurations.

Choose Akusto Wall C Extra Bass to get increased speech clarity due to the extra absorption feature for low frequency sounds.

Screens are ideal for strategic acoustic performance support. Akusto Screen is light and freestanding, so it can be re-positioned as needed.

12

AKUSTO WALL A

2700x1200x40

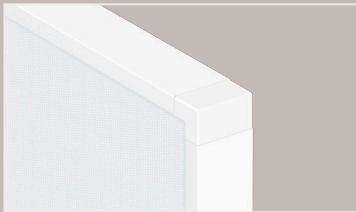

AKUSTO WALL C

2700x600x40

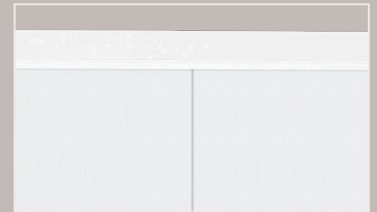

AKUSTO WALL C EXTRA BASS

2700x600x80



AKUSTO FREEDOM

300x300

≤400x400-1200x1200



AKUSTO ONE

Ø592x40

Ø792x40

Ø1192x40

592x592x40

1192x292x40

1192x592x40



AKUSTO TRIANGLE

513x592x40



AKUSTO HEXAGON

513x592x40



AKUSTO SCREEN

1500x1200x40



AKUSTO WALL A

Framed wall panels in wide range of colours.







AKUSTO WALL C EXTRA BASS

Shadow framed low frequency wall panel solution in wide range of colours.



AKUSTO WALL C

Smoothly framed wall panel solutions in wide range of colours.





AKUSTO WALL C

Smoothly framed wall panel solutions in wide range of colours.





AKUSTO FREEDOM

Custom-made framless wall panel solutions with a wide range of color possibilities.



CUSTOM SHAPES AND ENDLESS PATTERNS

UNIQUE IS THE NEW STANDARD

Create striking shapes and a gentle sound environment with Akusto wall panels. Draw your own custom shapes with Akusto Freedom or build one-of-a-kind patterns using Akusto Triangle and Hexagon.

FEATURES

- Unlimited shapes with Akusto Freedom
- Create patterns with Akusto Triangle & Akusto Hexagon
- Hang with Connect™ One Trim or glue directly to the wall
- Create 3D-effect with individual panels standing out
- Superior acoustic qualities





AKUSTO TRIANGLE

Frameless wall panel solutions in a wide range of colours



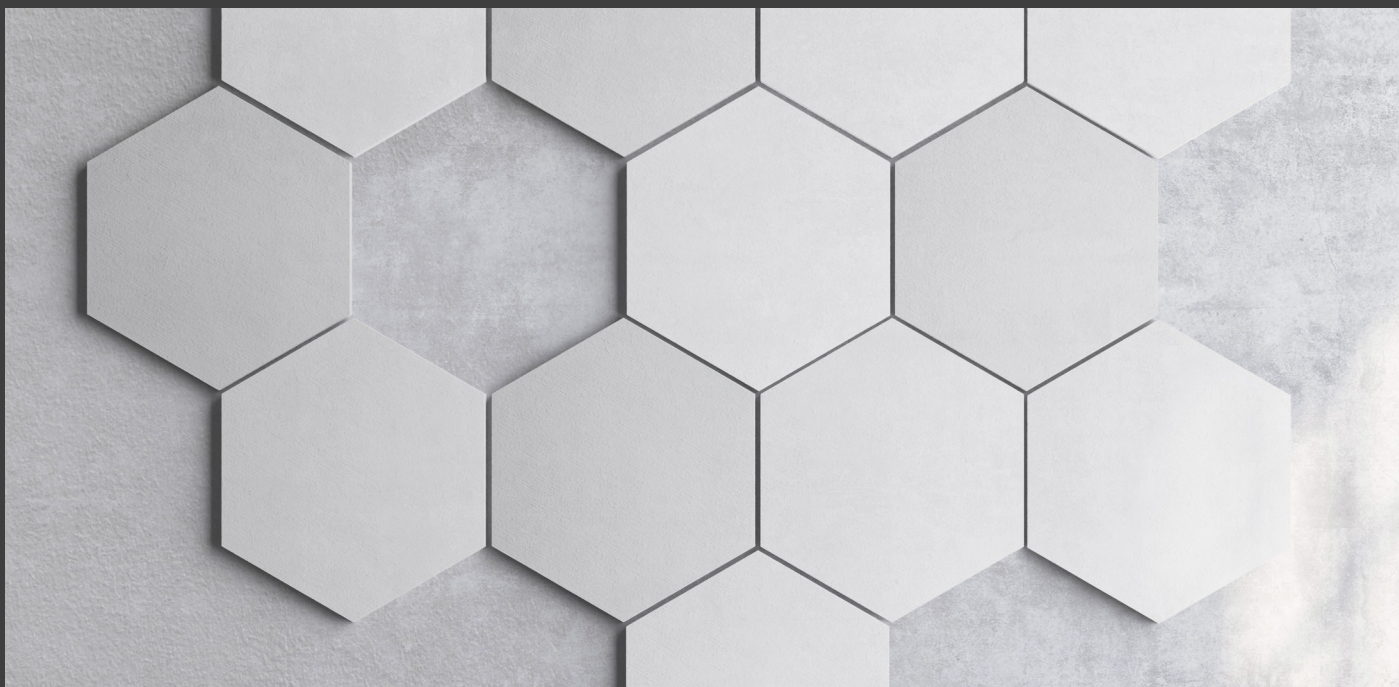

AKUSTO HEXAGON

Frameless wall panel solutions in a wide range of colours.



22



AKUSTO ONE

Easy to install frameless wall panels in many shapes and colours.

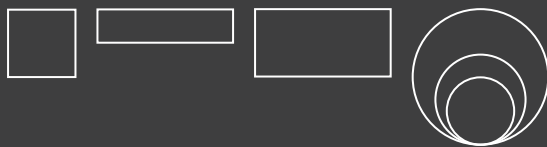



AKUSTO ONE

Easy to install frameless wall panels in many shapes and colours.

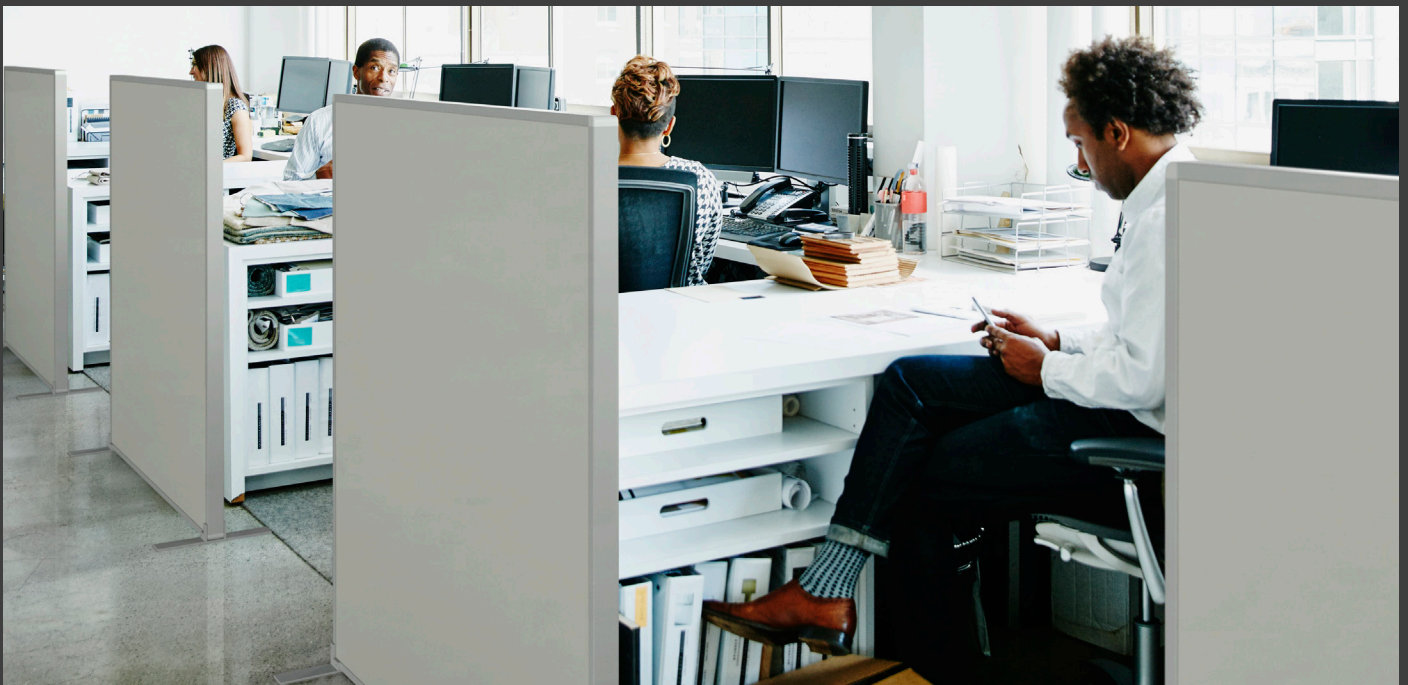
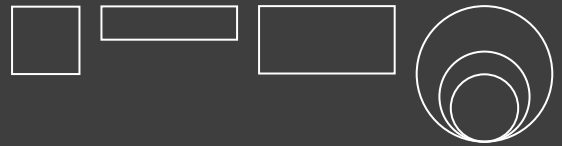

AKUSTO SCREEN

Smoothly framed wall panel solutions in wide range of colours.

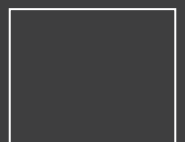

INSTALLATION METHODS

The innovative Connect™ accessories enable the wall absorbers to be mounted with a perfect fit and in many different ways. As Ecophon Akusto is designed for flexible placement, the creative ways to arrange them are almost endless.

ECOPHON E-TOOLS

Ecophon offers several useful tools and services for the different phases of the building process, from inspiration to specific maintenance instructions for your Ecophon products.

Read more and try our E-tools at www.ecophon.com/uk

ECOPHON AKUSTO™ ONE

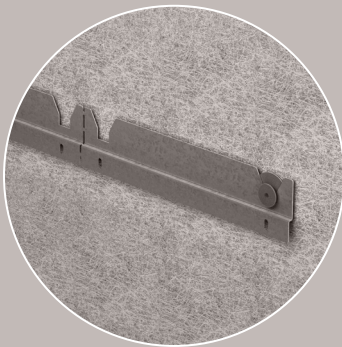

CONNECT ONE TRIM is screwed to the wall and act as a holder for Connect Absorber Anchor One, which is screwed into the back of the panel. Connect one trim is available in two versions. When combined 3D effects is created.



CONNECT ONE FIXING is a holder screwed to the wall. The panel is secured with a specially designed, textured button, available in several colours.



CONNECT ONE HOOK FIXING is a plate with hooks which is screwed to the wall and the panel is pressed onto the hooks.



ECOPHON AKUSTO™ WALL

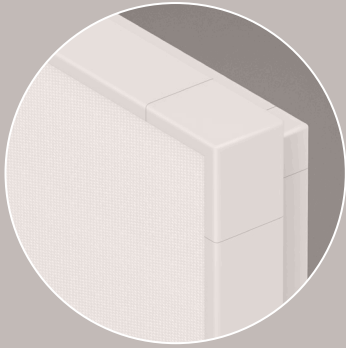

CONNECT SHADOW PROFILE has a design which creates a shadow effect. The elegant solution gives a light impression and allows you to create fields of colours and patterns both vertically and horizontally.

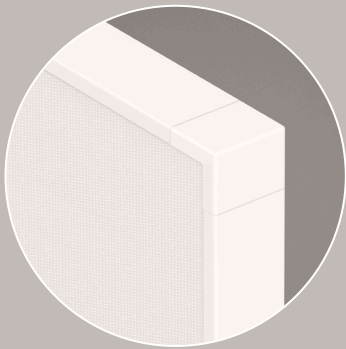

CONNECT THINLINE PROFILE is an elegant solution which allows you to create fields of colours and patterns both vertically and horizontally.

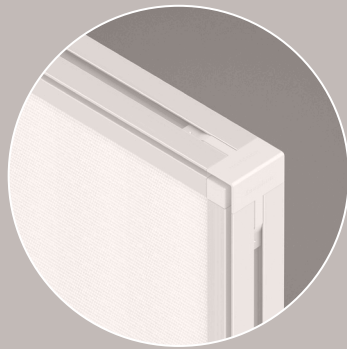



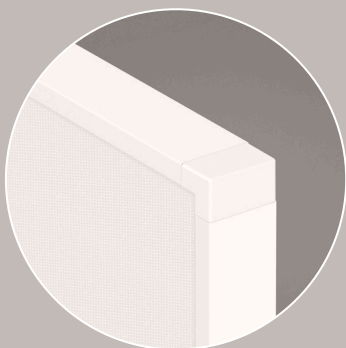





CONNECT WP PROFILE is a robust profile solution that establishes a distinct frame around the wall panel.

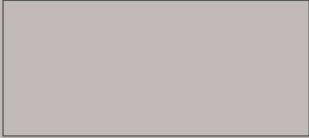
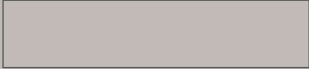

CONNECT CHANNEL TRIM is a simple and functional solution. It can be installed with Connect T24 Main Runners or by using Connect Recessed Profile.

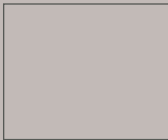

ECOPHON AKUSTO OVERVIEW

| SHAPE | PRODUCT | SIZE (MM) | INSTALLATION METHODS | | |
|---|----------------------------------|--------------------------------|----------------------------|----------------------------------|----------------------|
| | | | WALL WITH CONNECT THINLINE | WALL WITH CONNECT SHADOW PROFILE | WALL WITH CONNECT WP |
|  | Ecophon Akusto Wall A | 2700x1200x40 | • | | |
|  | Ecophon Akusto Wall C | 2700x600x40 | • | | • |
|  | Ecophon Akusto Wall C Extra Bass | 2700x600x80 | | • | |
|  | Ecophon Akusto Freedom | 300x300 | | | |
| | | ≤400x400-1200x1200 | | | |
|     | Ecophon Akusto One | 592x592x40 | | | |
| | | 1192x292x40 | | | |
| | | 1192x592x40 | | | |
| | | Ø592x40 Ø792x40 Ø1192x40 | | | |
|  | Ecophon Akusto Triangle | 513x592x40 | | | |
|  | Ecophon Akusto Hexagon | 513x592x40 | | | |
|  | Ecophon Akusto Screen | 1500x1200x40 | | | |

| WALL WITH CONNECT CHANNEL TRIM | WALL WITH CONNECT ONE HOOK | WALL WITH CONNECT ONE TRIM | WALL WITH CONNECT ABSORBER GLUE | FLOOR STANDING | SURFACE |
|--------------------------------|----------------------------|----------------------------|---------------------------------|----------------|---|
| • | | | | | Akutex FT Ecophon Texona Ecophon Super G |
| | | | | | Akutex FT Ecophon Texona Ecophon Super G Akutex HS |
| | | | | | Akutex FT Ecophon Texona |
| | • | | • | | Akutex FT |
| | • | • | • | | |
| • | • | | | | Akutex FT |
| • | • | | | | |
| • | • | | | | |
| • | • | • | | | |
| | • | • | • | | Akutex FT |
| | • | • | • | | Akutex FT |
| | | | | • | Ecophon Texona |



Ecophon Akusto panels contribute to a healthy indoor environment with superior acoustic absorption, low VOC emissions in line with the strictest requirements, and a full chemical transparency with verified Health Product Declarations. The low environmental footprint of our Akusto panels is third-party verified in Environmental Product Declarations.



For projects where environmental excellence is a priority, Ecophon offers you the Plant option, specifically designed to maximise the contribution of the ceiling to green building certification schemes. Our Plant panel range features bio-based materials, an industry-low CO₂ footprint and the lowest indoor air emissions, with the Eurofins Indoor Air Comfort Gold certification.

The products do not contribute to fire and the glass wool core of the Akusto tiles is tested and classified as non-combustible according to EN ISO 1182. Fire classification according to EN 13501-1, see Technical Properties on respectively product.

NOTE
More product and system information such as installation help and sustainability documentation can be found at www.ecophon.com/uk

COLOURS AND SURFACES

AKUTEX™ FT

The Akutex label guarantees that the product carrying it has a superior surface technology. Our research and development will always focus on visual aspects, acoustic properties, working environment, architectural trends and environmental aspects. This ensures that Akutex is always one step ahead.

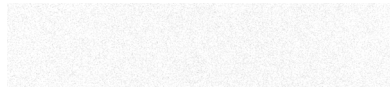

WHITE FROST
Nearest NCS colour sample S 0500-N.
Light reflectance 85%.



OCEAN STORM
Nearest NCS colour sample S 4020-R90B.
Light reflectance 24%.



MORNING DRIZZLE
Nearest NCS colour sample S 1002-B.
Light reflectance 69%.

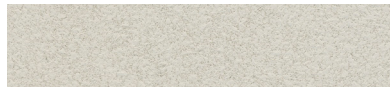

VOLCANIC ASH
Nearest NCS colour sample 2002-Y.
Light reflectance 56%.



MOONLIGHT SKY
Nearest NCS colour sample S 7020-R90B.
Light reflectance 7%.

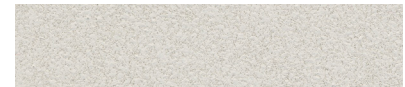

CLOUDY DAY
Nearest NCS colour sample S 1500-N.
Light reflectance 62%.

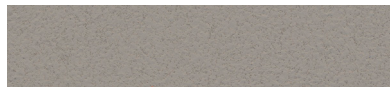

SILVER STONE
Nearest NCS colour sample S 4502-Y.
Light reflectance 29%.

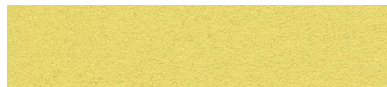

GOLDEN FIELD
Nearest NCS colour sample S 1040-G90Y.
Light reflectance 61%.



PEACH ROSE
Nearest NCS colour sample S 1515-Y80R.
Light reflectance 55%.

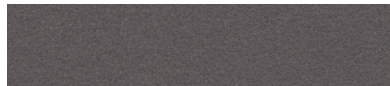

SILK SLATE
Nearest NCS colour sample S 7000-N.
Light reflectance 13%.



SUNSET HEAT
Nearest NCS colour sample S 2070-Y60R.
Light reflectance 20%.

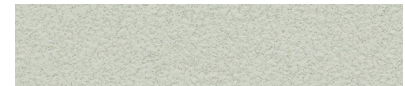

HIGHLAND FOG
Nearest NCS colour sample S 2005-G.
Light reflectance 55%.



GOJI BERRY
Nearest NCS colour sample S 3030-Y80R.
Light reflectance 27%.

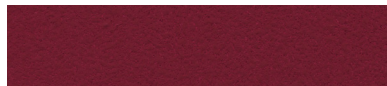

RUBY ROCK
Nearest NCS colour sample S 4050-R10B.
Light reflectance 7%.



SAGE GARDEN
Nearest NCS colour sample S 3010-B30G.
Light reflectance 40%.



SILENT STEAM
Nearest NCS colour sample S 2010-B.
Light reflectance 45%.

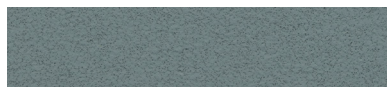

EUCALYPTUS LEAF
Nearest NCS colour sample S 5010-B30G.
Light reflectance 23%.



FRESH CLOVER
Nearest NCS colour sample S 3020-G40Y.
Light reflectance 35%.

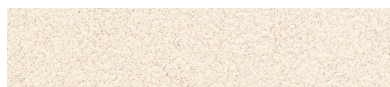

SCALLOP SHELLS
Nearest NCS colour sample S 0804-Y50R.
Light reflectance 76%.



SUMMER FOREST
Nearest NCS colour sample S 6030-G10Y.
Light reflectance 10%.

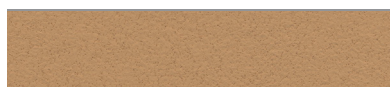

WET SAND
Nearest NCS colour sample S 3020-Y30R.
Light reflectance 35%.



DARK DIAMOND
Nearest NCS colour sample S 9000-N.
Light reflectance 4%.

NOTE
Colours may vary slightly between different production batches.
Reproduction of colours vary between print and reality.

ECOPHON TEXONA

If you want to create expressive sound absorbing wall or screen solutions with a wide range of colours, Texona is the perfect choice. Texona has a smooth textured surface and available in a variety of colours that allude to flavours.



SEA SALT

Nearest NCS colour sample S 0500-N.
Light reflectance 81%.

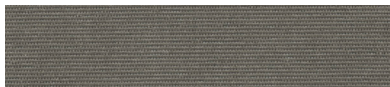

PEPPER

Nearest NCS colour sample S 6502-Y.
Light reflectance 17%.



GARLIC

Nearest NCS colour sample S 2502-Y.
Light reflectance 52%.



GINGER

Nearest NCS colour sample S 2005-Y30R.
Light reflectance 56%.



OYSTER

Nearest NCS colour sample S 4005-Y20R.
Light reflectance 32%.

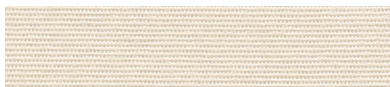

SCALLOP

Nearest NCS colour sample S 1005-Y40R.
Light reflectance 67%.

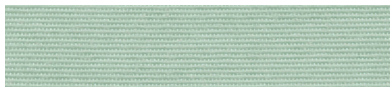

THYME

Nearest NCS colour sample S 2010-B90G.
Light reflectance 47%.



SAGE

Nearest NCS colour sample S 3010-B30G.
Light reflectance 41%.

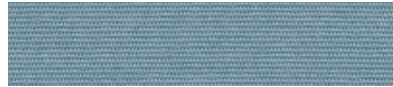

POPPY SEED

Nearest NCS colour sample S 3020-B10G.
Light reflectance 28%.



EUCALYPTUS

Nearest NCS colour sample S 5010-B30G.
Light reflectance 23%.

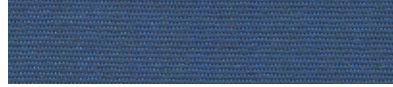

ACAI

Nearest NCS colour sample S 6020-R90B.
Light reflectance 12%.



PEACH

Nearest NCS colour sample S 1515-Y80R.
Light reflectance 52%.

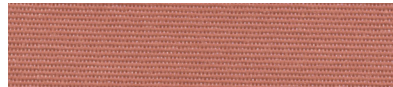

GOJI

Nearest NCS colour sample S 3030-Y80R.
Light reflectance 24%.



LIQUORICE

Nearest NCS colour sample S 9000-N.
Light reflectance 5%.

ECOPHON SUPER G

The Super G surface has been designed for environments where mechanical impact occurs. Super G is a glass fibre fabric with high impact resistance.



WHITE 085

Nearest NCS colour sample S 1002-Y.
Light reflectance 78%.

AKUTEX™ HS

Akutex™ HS is a painted, stain-protected surface for Hygiene applications where there are high demands for wet cleaning. The surface has a high resistance to water and the most common detergents and disinfectants.

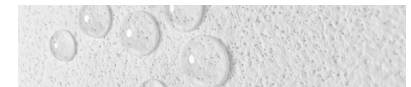

WHITE 500

Nearest NCS colour sample S 0500-N.
Light reflectance 84%.

NOTE

Colours vary between different production batches.

Reproduction of colours vary between print and reality.

COLOURS AND SURFACES

CONNECT THINLINE PROFILE



WHITE 02
Textured, S 1002-Y.



GREY 03
Textured, S 1500-N.



GREY 04
Textured, S 4500-N.



BLACK 01
Textured, S 9000-N.

CONNECT SHADOW PROFILE



GREY 03
Textured, S 1500-N.

CONNECT WP PROFILE



WHITE 03
Textured, S 0502-Y.



NATURAL ANODIZED
Textured, S 1000-N.



BLACK 01
Textured, S 9000-N.

CONNECT HD



WHITE 02
S 0500-Y.

NOTE

Colours may vary slightly between different production batches.

Reproduction of colours vary between print and reality.



10

11



SYSTEM

PROPERTIES

ACOUSTICS, TECHNICAL PROPERTIES AND INSTALLATION DIAGRAMS

- 34 Akusto Wall A
- 37 Akusto Wall C
- 37 Akusto Wall C Akutex HS
- 40 Akusto Wall C Extra Bass
- 42 Akusto Triangle
- 44 Akusto Hexagon
- 46 Akusto One
- 48 Akusto Screen

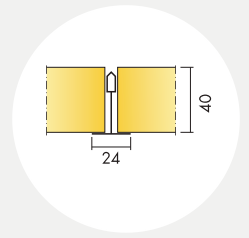

Ecophon Akusto™ Wall A

Acoustic:

Sound Absorption:

Test results according to EN ISO 354. Classification according to EN ISO 11654, and the single value ratings for Noise Reduction Coefficient, NRC and Sound Absorption Average, SAA according to ASTM C 423.

α_p , Practical sound absorption coefficient

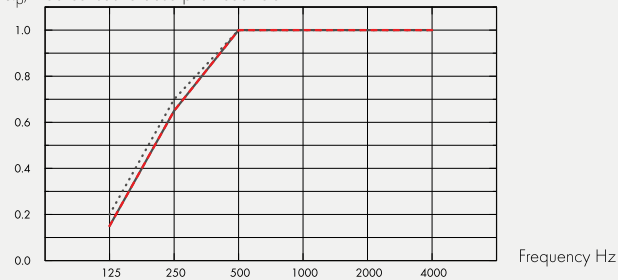

- Akusto Wall A Akutex FT 40 mm, 43 mm o.d.s.
 - Akusto Wall A Texona 40 mm, 43 mm o.d.s.
 - - - Akusto Wall A Super G 40 mm, 43 mm o.d.s.
- o.d.s = overall depth of system

| | THK mm | o.d.s. mm | α_p , Practical sound absorption coefficient | | | | | | α_w | Sound absorption class |
|-----------|--------|-----------|---|--------|--------|---------|---------|---------|------------|------------------------|
| | | | 125 Hz | 250 Hz | 500 Hz | 1000 Hz | 2000 Hz | 4000 Hz | | |
| Akutex FT | 40 | 43 | 0.20 | 0.70 | 1.00 | 1.00 | 1.00 | 1.00 | 1.00 | A |
| Texona | 40 | 43 | 0.15 | 0.65 | 1.00 | 1.00 | 1.00 | 1.00 | 1.00 | A |
| Super G | 40 | 43 | 0.15 | 0.65 | 1.00 | 1.00 | 1.00 | 1.00 | 0.95 | A |

| THK mm | AC(1.5) |
|--------|---|
| 40 | Articulation Class, ASTM E1111, ASTM E1110 230 |

Indoor Air Quality:

| Certificate / Label | Plant |
|------------------------------|--------------|
| Eurofins Indoor Air Comfort® | IAC IAC Gold |
| French VOC | A A+ |
| Finnish M1 | • • |

Environmental Footprint: Life-cycle stages A1 to C4 from EPD, in conformity with ISO 14025 / EN 15804

| | kg CO ₂ equiv/m ² |
|---------------------------------|---|
| Akusto Wall A - Texona | 4,74 |
| Akusto Wall A - Texona/Plant | 5,30 |
| Akusto Wall A - Akutex FT | 3,96 |
| Akusto Wall A - Akutex FT/Plant | 4,29 |
| Akusto Wall A - Super G | 6,21 |
| Akusto Wall A - Super G/Plant | 5,93 |

Circularity: Minimum post-consumer recycled content: 53%, Recyclability: Fully recyclable,

Fire safety: The glass wool core of the tiles is tested and classified as non-combustible according to EN ISO 1182. Europe: EN 13501-1, A2-s1,d0,

Humidity Resistance: According to EN 13964:2014 Standard: Class C, RH 95% and 30°C, Plant: Class A, RH 70% and 25°C,

Visual appearance: Akusto Wall in white has high light reflectance. Light reflectance and nearest NCS colour sample for all the different colours: See Ecophon Colours and surfaces.

Cleanability: Daily dusting, vacuum cleaning and weekly wet wiping (Super G and Akutex FT surfaces). Weekly dusting and vacuum cleaning (Texona surface).

Use of disinfectants: Texona Ginger, Sea salt, Thyme, Oyster and Garlic withstand the frequent use of ethanol (70%)-based disinfectants. Dampen a soft polyester microfiber cloth with the solution and wipe the surface in gentle circular movements.

Accessibility: The tiles are not demountable except in selected installation diagrams. See quantity specification for more information.

Installation: Installed according to installation diagrams, installation guides and drawing aid. For information regarding minimum overall depth of system see quantity specification. The systems should not be placed behind goals or similar areas where they frequently will be hit by hard ball shots. In such cases a protective net in front of the system is recommended.

System weight: The weight of the system (including profile system) should be approximately 4 kg/m².

Mechanical properties: No additional live load is allowed.

Impact Resistance: Tested and classified to fulfil the requirements of DIN 18032-3, equivalent to 1A according to EN13964. Texona surface has moderate impact resistance. Please note: Where the panels are subjected to frequent blows and impacts e.g. behind goal mouths, protection in form of e.g. restraining nets or wooden slats is required. Super G: M353, Fulfills,

CE: Ecophon ceiling systems are CE marked according to the European harmonized standard EN13964:2014. CE marked construction products are covered by a Declaration of Performance (DOP) which enables customers and users to easily compare performance of products available on the European market.

M353
Installation diagram (M353) for Ecophon Akusto Wall A

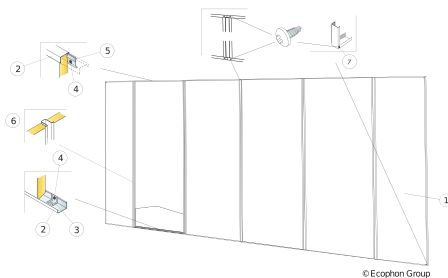

M504
Installation diagram (M504) for Ecophon Akusto Wall A

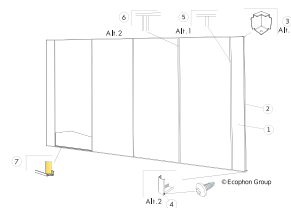

M593
Installation diagram (M593) for Ecophon Akusto Wall A vertical installation with Connect Thinline profiles.

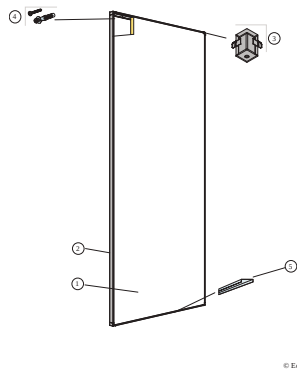

M595
Installation diagram (M595) for Ecophon Akusto Wall A horizontal installation with Connect Thinline profiles.

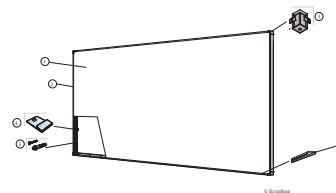

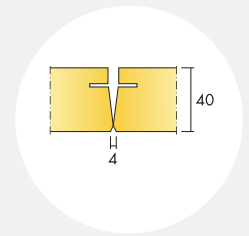

Ecophon Akusto™ Wall C

Acoustic:

Sound Absorption:

Test results according to EN ISO 354. Classification according to EN ISO 11654, and the single value ratings for Noise Reduction Coefficient, NRC and Sound Absorption Average, SAA according to ASTM C 423.

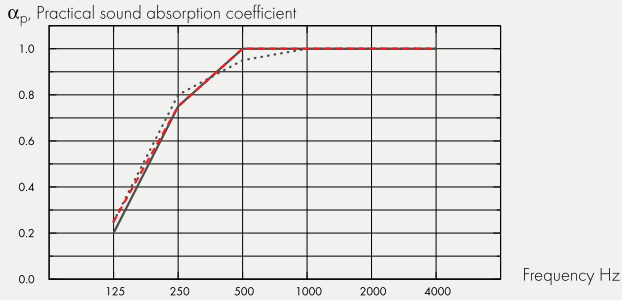

- Akusto Wall C Akutex FT 40 mm, 43 mm o.d.s.
 - Akusto Wall C Texona 40 mm, 43 mm o.d.s.
 - - - Akusto Wall C Super G 40 mm, 43 mm o.d.s.
- o.d.s = overall depth of system

| | THK mm | o.d.s. mm | α_p Practical sound absorption coefficient | | | | | α_w | Sound absorption class |
|-----------|--------|-----------|---|--------|--------|---------|---------|------------|------------------------|
| | | | 125 Hz | 250 Hz | 500 Hz | 1000 Hz | 2000 Hz | | |
| Akutex FT | 40 | 43 | 0.25 | 0.80 | 0.95 | 1.00 | 1.00 | 1.00 | A |
| Texona | 40 | 43 | 0.20 | 0.75 | 1.00 | 1.00 | 1.00 | 1.00 | A |
| Super G | 40 | 43 | 0.25 | 0.75 | 1.00 | 1.00 | 1.00 | 1.00 | A |

| THK mm | AC(1.5) |
|--------|---|
| 40 | Articulation Class, ASTM E1111, ASTM E1110 240 |

Indoor Air Quality:

| Certificate / Label | Plant |
|------------------------------|--------------|
| Eurofins Indoor Air Comfort® | IAC IAC Gold |
| French VOC | A A+ |
| Finnish M1 | • • |

M355

Installation diagram (M355) for Ecophon Akusto Wall C horizontal installation

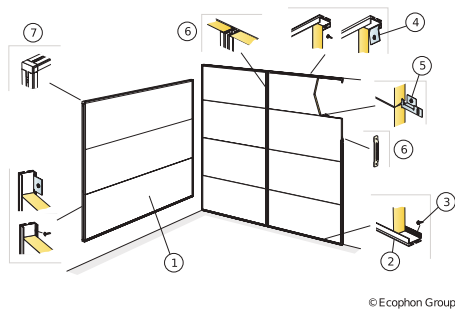

© Ecophon Group

M592

Installation diagram (M592) for Ecophon Akusto Wall C horizontal installation with Connect Thinline profiles

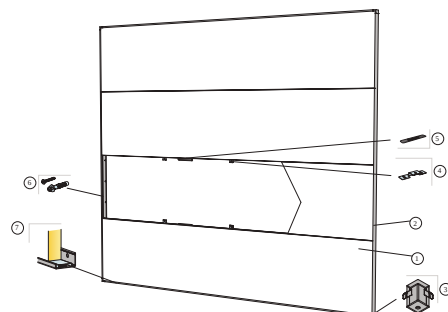

Fire safety: The glass wool core of the tiles is tested and classified as non-combustible according to EN ISO 1182. Europe: EN 13501-1, A2-s1,d0,

Humidity Resistance: According to EN 13964:2014 Standard: Class C, RH 95% and 30°C, Plant: Class A, RH 70% and 25°C,

Visual appearance: Akusto Wall in white has high light reflectance. Light reflectance and nearest NCS colour sample for all the different colours: See Ecophon Colours and surfaces.

Cleanability: Daily dusting, vacuum cleaning and weekly wet wiping (Super G and Akutex FT surfaces). Weekly dusting and vacuum cleaning (Texona surface).

Use of disinfectants: Texona Ginger, Sea salt, Thyme, Oyster and Garlic withstand the frequent use of ethanol (70%)-based disinfectants. Dampen a soft polyester microfiber cloth with the solution and wipe the surface in gentle circular movements.

Accessibility: The tiles are not demountable except in selected installation diagrams. See quantity specification for more information.

Installation: Installed according to installation diagrams, installation guides and drawing aid. For information regarding minimum overall depth of system see quantity specification. The systems should not be placed behind goals or similar areas where they frequently will be hit by hard ball shots. In such cases a protective net in front of the system is recommended.

System weight: The weight of the system (including profile system) should be approximately 5 kg/m².

Mechanical properties: No additional live load is allowed.

Impact Resistance: Tested and classified to fulfil the requirements of DIN 18032-3, equivalent to 1A according to EN13964. Super G: M354, Fulfills,

CE: Ecophon ceiling systems are CE marked according to the European harmonized standard EN13964:2014. CE marked construction products are covered by a Declaration of Performance (DOP) which enables customers and users to easily compare performance of products available on the European market.

M609

Installation diagram (M609) for Ecophon Akusto Wall C vertical installation with Connect Thinline profiles.

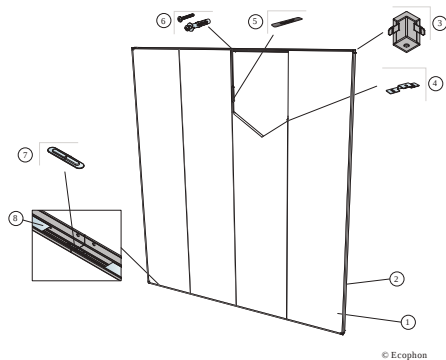

M354

Installation diagram (M354) for Ecophon Akusto Wall C vertical installation

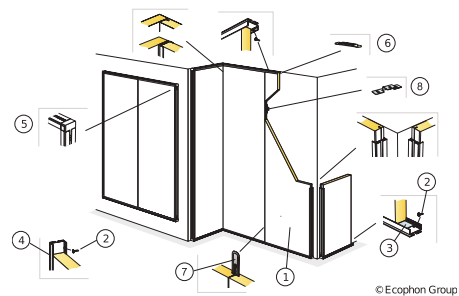

M355

Installation diagram (M355) for Ecophon Akusto Wall C horizontal installation

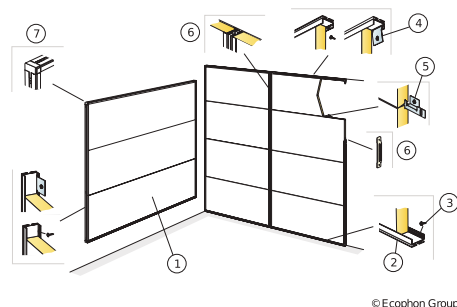

M592

Installation diagram (M592) for Ecophon Akusto Wall C horizontal installation with Connect Thinline profiles

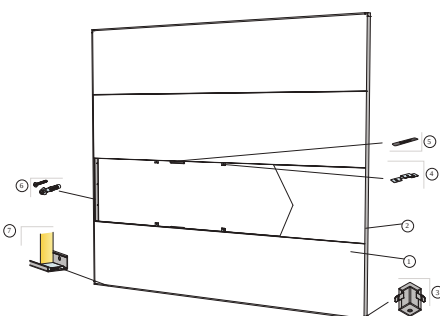

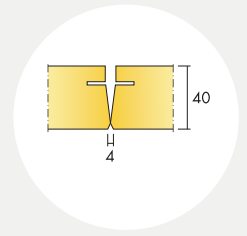

Ecophon Akusto™ Wall C Akutex HS

Acoustic:

Sound Absorption:

Test results according to EN ISO 354. Classification according to EN ISO 11654.

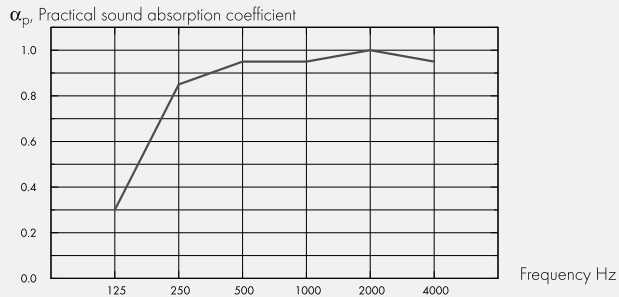

– Akusto Wall C Akutex HS 40 mm, 60 mm o.d.s.

o.d.s = overall depth of system

| THK mm | o.d.s. mm | α_p , Practical sound absorption coefficient | | | | | | α_w | Sound absorption class |
|-----------|-----------|---|--------|--------|---------|---------|---------|------------|------------------------|
| | | 125 Hz | 250 Hz | 500 Hz | 1000 Hz | 2000 Hz | 4000 Hz | | |
| 40 | 60 | 0.30 | 0.85 | 0.95 | 0.95 | 1.00 | 0.95 | 1.00 | A |

Indoor Air Quality:

Certificate / Label

| | |
|------------------------------|-----|
| Eurofins Indoor Air Comfort® | IAC |
| French VOC | A |
| Finnish M1 | • |

Circularity: Minimum post-consumer recycled content: 60%, Recyclability: Fully recyclable,

Environmental Footprint: Life-cycle stages A1 to C4 from EPD, in conformity with ISO 14025 / EN 15804

| | kg CO ₂ equiv/m ² |
|---------------------------|---|
| Akusto Wall C - Akutex HS | 7,77 |

Fire safety: The glass wool core of the tiles is tested and classified as non-combustible according to EN ISO 1182. Europe: EN 13501-1, A2-s1,d0,

Humidity Resistance: Class C, relative humidity 95% and 30°C, according to EN 13964:2014

Visual appearance: White 500, nearest NCS colour sample S 0500-N, 84% light reflectance.

Cleanability: Daily dusting and vacuum cleaning. Weekly wet wiping.

Accessibility: The tiles are not demountable except in selected installation diagrams. See quantity specification for more information.

Installation: Installed according to installation diagrams, installation guides and drawing aid. For information regarding minimum overall depth of system see quantity specification. The systems should not be placed behind goals or similar areas where they frequently will be hit by hard ball shots. In such cases a protective net in front of the system is recommended.

Mechanical properties: See table about Max live load and Min load bearing capacity and Functional demands, Mechanical properties at www.ecophon.com.

CE: Ecophon ceiling systems are CE marked according to the European harmonized standard EN13964:2014. CE marked construction products are covered by a Declaration of Performance (DOP) which enables customers and users to easily compare performance of products available on the European market.

Installation diagram in detail www.ecophon.com

M594C4

Installation diagram (M594C4) for Ecophon Akusto™ Wall C Akutex HS vertical installation with Connect Thinline Profile and distance.

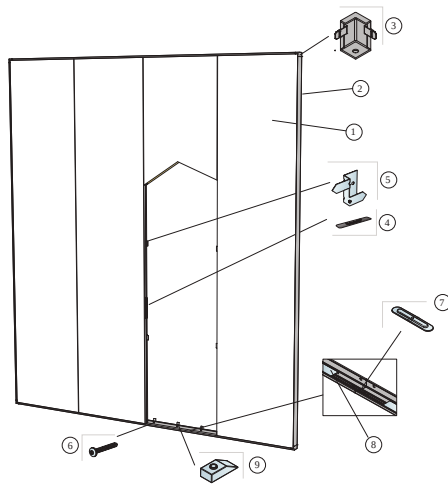

© Ecophon

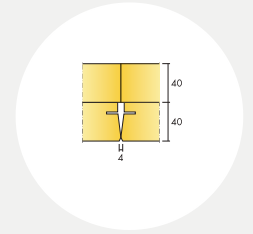

Ecophon Akusto™ Wall C Extra Bass

Acoustic:

Sound Absorption:

Test results according to EN ISO 354. Classification according to EN ISO 11654, and the single value ratings for Noise Reduction Coefficient, NRC and Sound Absorption Average, SAA according to ASTM C 423.

α_p , Practical sound absorption coefficient

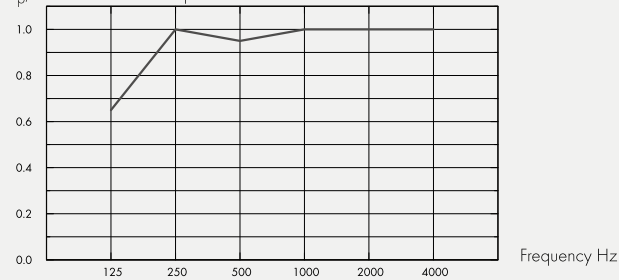

– Akusto Wall C Extra Bass 80 mm, 80 mm o.d.s.
o.d.s = overall depth of system

| | THK mm | o.d.s. mm | α_p , Practical sound absorption coefficient | | | | | | α_w | Sound absorption class |
|------------|--------|-----------|---|--------|--------|---------|---------|---------|------------|------------------------|
| | | | 125 Hz | 250 Hz | 500 Hz | 1000 Hz | 2000 Hz | 4000 Hz | | |
| Extra Bass | 80 | 80 | 0.65 | 1.00 | 0.95 | 1.00 | 1.00 | 1.00 | 1.00 | A |

| | THK mm | o.d.s. mm | NRC | SAA |
|------------|--------|-----------|------|------|
| Extra Bass | 80 | 80 | 1.00 | 1.00 |

Indoor Air Quality:

Certificate / Label

| | |
|------------------------------|-----|
| Eurofins Indoor Air Comfort® | IAC |
| French VOC | A |
| Finnish M1 | • |

Circularity: Minimum post-consumer recycled content: 60%, Recyclability: Fully recyclable,

Environmental Footprint: Life-cycle stages A1 to C4 from EPD, in conformity with ISO 14025 / EN 15804

| | kg CO ₂ equiv/m ² |
|------------------------------------|---|
| Akusto Wall C Extra Bass/Texona | 10,8 |
| Akusto Wall C Extra Bass/Akutex FT | 10,4 |

Fire safety: The glass wool core of the tiles is tested and classified as non-combustible according to EN ISO 1182. Europe: EN 13501-1, A2-s1,d0,

Humidity Resistance: Class C, relative humidity 95% and 30°C, according to EN 13964:2014

Visual appearance: Akusto Wall in white has high light reflectance. Light reflectance and nearest NCS colour sample for all the different colours: See Ecophon Colours and surfaces.

Cleanability: Daily dusting, vacuum cleaning and weekly wet wiping (Akutex FT surfaces). Weekly dusting and vacuum cleaning (Texona surfaces).

Accessibility: The tiles are not demountable.

Installation: Installed according to installation diagrams, installation guides and drawing aid.

System weight: The weight of the system depends on the dimensions of the installation. 2700 x 2700 mm installations has a system weight of approximately 7 kg/m² (including profile system).

Mechanical properties: No additional live load is allowed.

CE: Ecophon ceiling systems are CE marked according to the European harmonized standard EN13964:2014. CE marked construction products are covered by a Declaration of Performance (DOP) which enables customers and users to easily compare performance of products available on the European market.

Installation diagram in detail www.ecophon.com

M535

Installation diagram (M535) for Ecophon Akusto Wall C Extra Bass vertical installation with Connect shadow profiles.

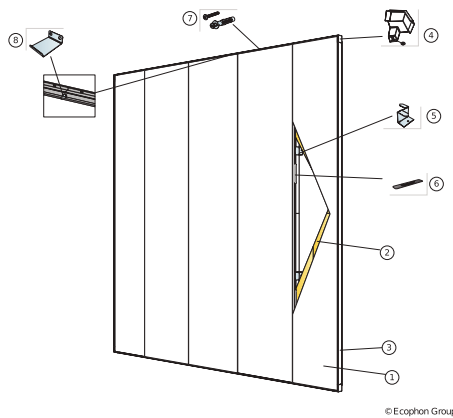

M547

Installation diagram (M547) for Ecophon Akusto Wall Bass horizontal installation with Connect shadow profiles.

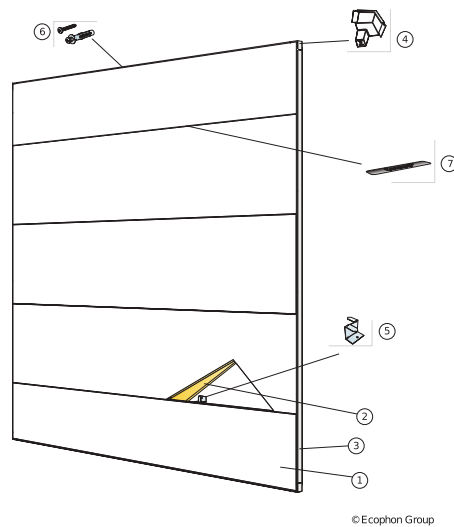

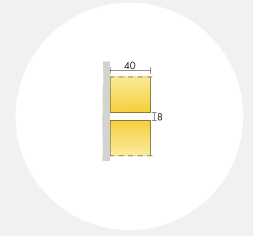

Ecophon Akusto™ Triangle

Acoustic: The values in the diagram refer to a single unit.

Sound Absorption:

Based on test results according to EN ISO 354.

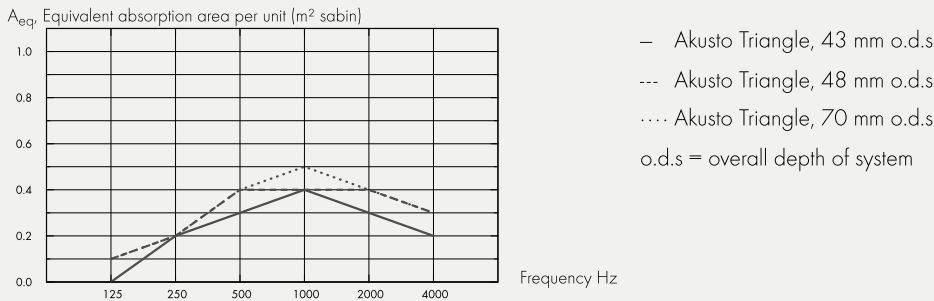

| THK mm | o.d.s. mm | A _{eq} Equivalent absorption area per unit (m ² sabin) | | | | | |
|-----------|-----------|--|--------|--------|---------|---------|---------|
| | | 125 Hz | 250 Hz | 500 Hz | 1000 Hz | 2000 Hz | 4000 Hz |
| 40 | 43 | 0.0 | 0.2 | 0.3 | 0.4 | 0.3 | 0.2 |
| 40 | 48 | 0.1 | 0.2 | 0.4 | 0.4 | 0.4 | 0.3 |
| 40 | 70 | 0.1 | 0.2 | 0.4 | 0.5 | 0.4 | 0.3 |

Indoor Air Quality:

Certificate / Label

| | |
|------------------------------|-----|
| Eurofins Indoor Air Comfort® | IAC |
| French VOC | A |
| Finnish M1 | • |

Circularity: Minimum post-consumer recycled content: 60%, Recyclability: Fully recyclable,

Fire safety: The glass wool core of the tiles is tested and classified as non-combustible according to EN ISO 1182. Europe: EN 13501-1, A2-s1,d0,

Humidity Resistance: Class C, relative humidity 95% and 30°C, according to EN 13964:2014

Visual appearance: Akusto Wall in white has high light reflectance. Light reflectance and nearest NCS colour sample for all the different colours: See Ecophon Colours and surfaces.

Cleanability: Akutex FT: Daily dusting and vacuum cleaning. Weekly wet wiping. For more info see Colours and surfaces.

Accessibility: The tiles are easily demountable.

Installation: Installed according to installation diagrams, installation guides and drawing aid. For information regarding minimum overall depth of system see quantity specification. Rendered surfaces must have sufficient strength to be able to carry the load imposed by the tiles. If doubts, test gluing should be carried out. The surface should always be dry and clean. For best result the surface should be even, however an acceptable result could be achieved on slightly uneven surfaces.

Mechanical properties: No additional live load is allowed.

CE: Ecophon ceiling systems are CE marked according to the European harmonized standard EN13964:2014. CE marked construction products are covered by a Declaration of Performance (DOP) which enables customers and users to easily compare performance of products available on the European market.

Installation diagram in detail www.ecophon.com

M585

Installation diagram (M585) for Ecophon Akusto Triangle

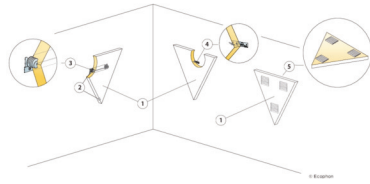

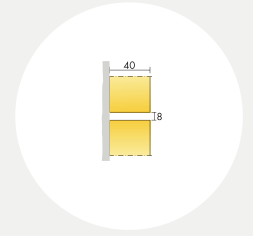

Ecophon Akusto™ Hexagon

Acoustic: The values in the diagram refer to a single unit.

Sound Absorption:

Based on test results according to EN ISO 354.

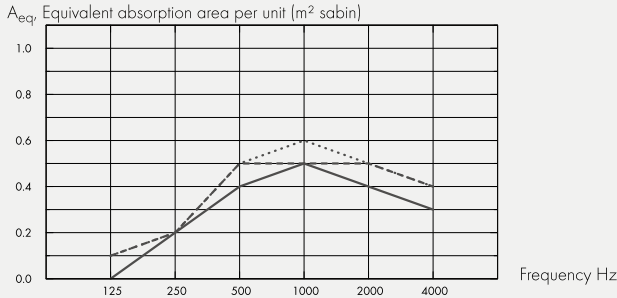

- Akusto Triangle, 43 mm o.d.s
 - - - Akusto Hexagon, 48 mm o.d.s
 - · · Akusto Hexagon, 70 mm o.d.s
- o.d.s = overall depth of system

| THK mm | o.d.s. mm | A _{eq} Equivalent absorption area per unit (m ² sabin) | | | | | |
|--------|-----------|--|--------|--------|---------|---------|---------|
| | | 125 Hz | 250 Hz | 500 Hz | 1000 Hz | 2000 Hz | 4000 Hz |
| 40 | 43 | 0.0 | 0.2 | 0.4 | 0.5 | 0.4 | 0.3 |
| 40 | 48 | 0.1 | 0.2 | 0.5 | 0.5 | 0.5 | 0.4 |
| 40 | 70 | 0.1 | 0.2 | 0.5 | 0.6 | 0.5 | 0.4 |

Indoor Air Quality:

Certificate / Label

| | |
|------------------------------|-----|
| Eurofins Indoor Air Comfort® | IAC |
| French VOC | A |
| Finnish M1 | • |

Circularity: Minimum post-consumer recycled content: 60%, Recyclability: Fully recyclable,

Fire safety: The glass wool core of the tiles is tested and classified as non-combustible according to EN ISO 1182. Europe: EN 13501-1, A2-s1,d0,

Humidity Resistance: Class C, relative humidity 95% and 30°C, according to EN 13964:2014

Visual appearance: Akusto Wall in white has high light reflectance. Light reflectance and nearest NCS colour sample for all the different colours: See Ecophon Colours and surfaces.

Cleanability: Akutex FT: Daily dusting and vacuum cleaning. Weekly wet wiping. For more info see Colours and surfaces.

Accessibility: The tiles are easily demountable.

Installation: Installed according to installation diagrams, installation guides and drawing aid. For information regarding minimum overall depth of system see quantity specification. Rendered surfaces must have sufficient strength to be able to carry the load imposed by the tiles. If doubts, test gluing should be carried out. The surface should always be dry and clean. For best result the surface should be even, however an acceptable result could be achieved on slightly uneven surfaces.

Mechanical properties: No additional live load is allowed.

CE: Ecophon ceiling systems are CE marked according to the European harmonized standard EN13964:2014. CE marked construction products are covered by a Declaration of Performance (DOP) which enables customers and users to easily compare performance of products available on the European market.

Installation diagram in detail www.ecophon.com

M586

Installation diagram (M586) for Ecophon Akusto Hexagon

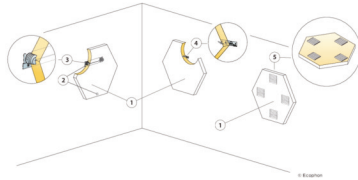

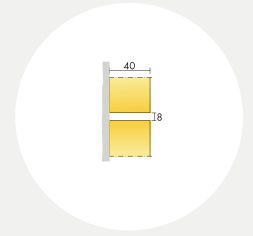

Ecophon Akusto™ One

Acoustic: The values in the diagram refer to a single unit. If the units are arranged in a cluster with distances between units less than 0,5 meters, the A_{eq} per unit will be slightly reduced.

Sound Absorption:

Test results according to EN ISO 354.

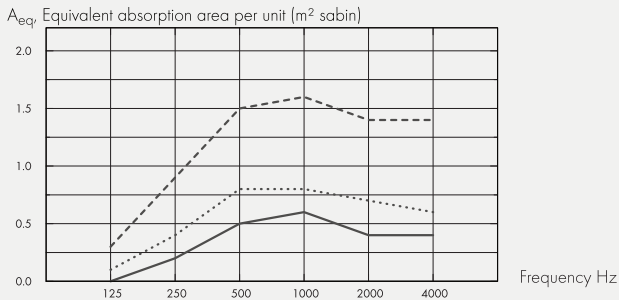

- Akusto One Ø592, 48 mm o.d.s.
 - Akusto One Ø792, 48 mm o.d.s.
 - Akusto One Ø1192, 48 mm o.d.s.
- o.d.s = overall depth of system

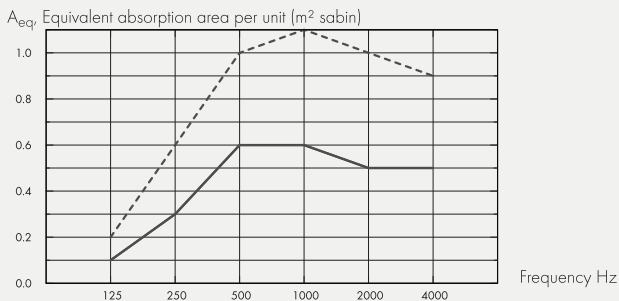

- Akusto One 592x592, 48 mm o.d.s.
 - Akusto One 1192x292, 48 mm o.d.s.
 - Akusto One 1192x592, 48 mm o.d.s.
- o.d.s = overall depth of system

| | THK mm | o.d.s. mm | A_{eq} Equivalent absorption area per unit (m² sabin) | | | | | |
|-------|--------|-----------|---|--------|--------|---------|---------|---------|
| | | | 125 Hz | 250 Hz | 500 Hz | 1000 Hz | 2000 Hz | 4000 Hz |
| Ø592 | 40 | 48 | 0.0 | 0.2 | 0.5 | 0.6 | 0.4 | 0.4 |
| Ø792 | 40 | 48 | 0.1 | 0.4 | 0.8 | 0.8 | 0.7 | 0.6 |
| Ø1192 | 40 | 48 | 0.3 | 0.9 | 1.5 | 1.6 | 1.4 | 1.4 |

| | THK mm | o.d.s. mm | A_{eq} Equivalent absorption area per unit (m² sabin) | | | | | |
|----------|--------|-----------|---|--------|--------|---------|---------|---------|
| | | | 125 Hz | 250 Hz | 500 Hz | 1000 Hz | 2000 Hz | 4000 Hz |
| 592x592 | 40 | 48 | 0.1 | 0.3 | 0.6 | 0.6 | 0.5 | 0.5 |
| 1192x292 | 40 | 48 | 0.1 | 0.3 | 0.6 | 0.6 | 0.5 | 0.5 |
| 1192x592 | 40 | 48 | 0.2 | 0.6 | 1.0 | 1.1 | 1.0 | 0.9 |

Indoor Air Quality:

Certificate / Label

| | |
|------------------------------|-----|
| Eurofins Indoor Air Comfort® | IAC |
| French VOC | A |
| Finnish M1 | • |

Environmental Footprint: Life-cycle stages A1 to C4 from EPD, in conformity with ISO 14025 / EN 15804

| | kg CO ₂ equiv/m ² |
|------------------------|---|
| Akusto One - Akutex FT | 7,59 |
| Akusto One - Texona | 9,42 |

Circularity: Minimum post-consumer recycled content: 61%, Recyclability: Fully recyclable,

Fire safety: The glass wool core of the tiles is tested and classified as non-combustible according to EN ISO 1182. Europe: EN 13501-1, A2-s1,d0,

Humidity Resistance: Class C, relative humidity 95% and 30°C, according to EN 13964:2014

Visual appearance: Akusto Wall in white has high light reflectance. Light reflectance and nearest NCS colour sample for all the different colours: See Ecophon Colours and surfaces.

Cleanability: Daily dusting, vacuum cleaning and weekly wet wiping (Akutex FT surfaces). Weekly dusting and vacuum cleaning (Texona surfaces).

Accessibility: The tiles are easily demountable.

Installation: Installed according to installation diagrams, installation guides and drawing aid. For information regarding minimum overall depth of system see quantity specification.

System weight: The weight of the system (depending on size and including profile system) should be approximately 2,0 - 4,5 kg.

Mechanical properties: No additional live load is allowed.

CE: Ecophon ceiling systems are CE marked according to the European harmonized standard EN13964:2014. CE marked construction products are covered by a Declaration of Performance (DOP) which enables customers and users to easily compare performance of products available on the European market.

Installation diagram in detail www.ecophon.com

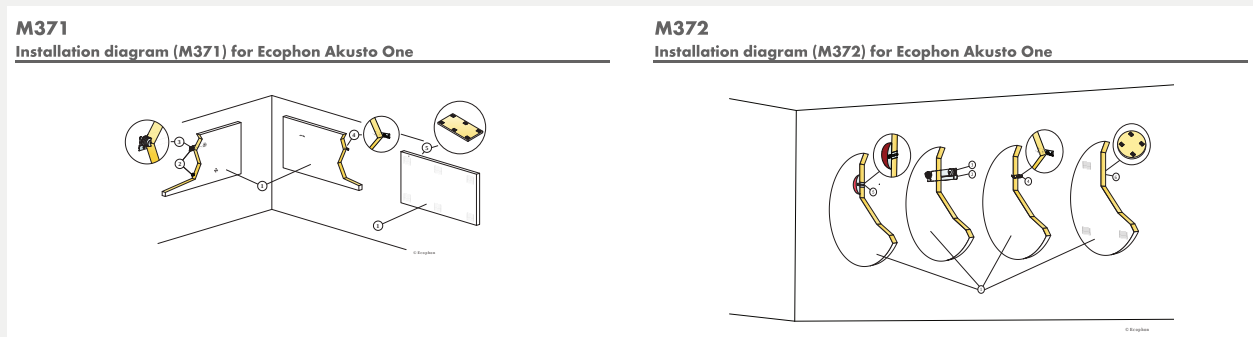

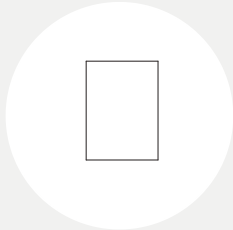

Ecophon Akusto™ Screen

Acoustic:

Sound Absorption:

Sound absorption and sound attenuation test results according to ISO 20189.

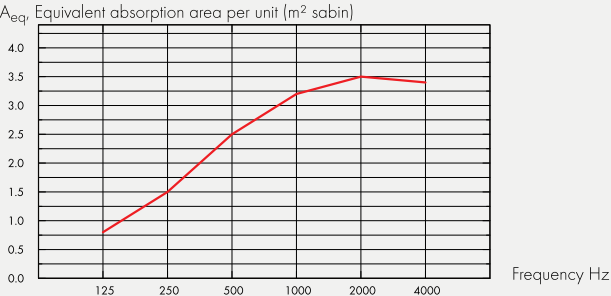

— Akusto Screen, size 1500x1200 mm
o.d.s = overall depth of system

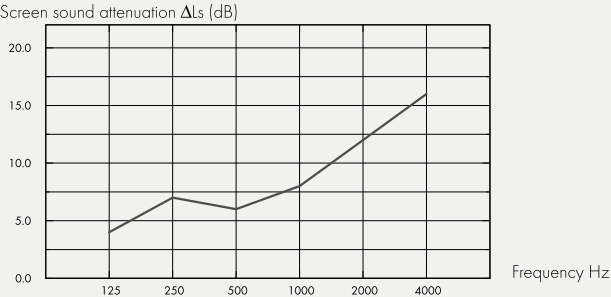

— Akusto Screen, size 1500x1200 mm
o.d.s = overall depth of system

| | THK mm | A _{eq} Equivalent absorption area per unit (m ² sabin) | | | | | |
|-----------|-----------|--|--------|--------|---------|---------|---------|
| | | 125 Hz | 250 Hz | 500 Hz | 1000 Hz | 2000 Hz | 4000 Hz |
| 1500x1200 | 40 | 0.8 | 1.5 | 2.5 | 3.2 | 3.5 | 3.4 |

| | THK mm | Screen sound attenuation ΔLs (dB) | | | | | | Weighted screen sound attenuation (dB) |
|-----------|-----------|-----------------------------------|--------|--------|---------|---------|---------|--|
| | | 125 Hz | 250 Hz | 500 Hz | 1000 Hz | 2000 Hz | 4000 Hz | |
| 1500x1200 | 40 | 4.0 | 7.0 | 6.0 | 8.0 | 12.0 | 16.0 | 10.0 |

Indoor Air Quality:

Certificate / Label
French VOC, A •

Circularity: *this value does not take into account the aluminium frame Minimum post-consumer recycled content: 48%*, Recyclability: Fully recyclable,

Humidity Resistance: Class A, relative humidity 70% and 25°C, according to EN 13964:2014

Visual appearance: Texona in white has high light reflectance. For more information regarding visual appearance of the various surfaces: See Ecophon Colours and surfaces.

Cleanability: Weekly dusting and vacuum cleaning.

Use of disinfectants: Texona Ginger, Sea salt, Thyme, Oyster and Garlic withstand the frequent use of ethanol (70%)-based disinfectants. Dampen a soft polyester microfiber cloth with the solution and wipe the surface in gentle circular movements.

Installation: Installed according to the installation guide that is delivered with the product.

Mechanical properties: The product is tested according to EN14073-2 and EN1023.

Installation diagram in detail www.ecophon.com

M526

Installation diagram (M515) for Ecophon Akusto Screen

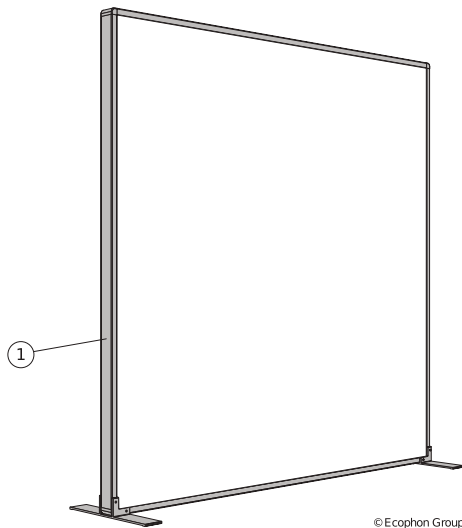

© Ecophon Group



Ecophon is the leading supplier of indoor acoustic solutions that improve working performance and quality of life. We believe in the difference sound can make to our everyday lives, and are passionate advocates for the importance of room acoustics to people's wellbeing - whatever the space, activity or need.

Having a sound effect on people is the principle that guides all we do. We're proud of the Swedish heritage and human approach that promise is founded on. Our uncompromising commitment to transparent sustainable practice. And, as members of the Saint-Gobain Group, to be doing our part in making the world a better home.

Any picture, description, illustration and dimensions contained in this brochure is for information purpose only and is not contractual. This brochure shows Ecophon products and may contain third-party's products. Ecophon shall not be liable for any misprint. Ecophon reserves the right to change product specifications at any time without prior notice. Recommendations of use and installation/assembly, as well as storage, maintenance and indoor environment conditions, must always be respected. Please refer to the applicable technical documentation, such as technical data sheet and installation guidelines. For a comprehensive and up-to-date library of information, including the last version of applicable General Terms and Conditions of Sales, please visit www.ecophon.com