

ECOPHON

# SOLO™

EXPERIENCING FREEDOM OF EXPRESSION



**04 ABOUT ECOPHON**

**06 GOOD ACOUSTICS MATTER EVERYWHERE**

**08 TOWARDS NET ZERO ACOUSTICS**

**10 FREEDOM OF EXPRESSION  
WITH ECOPHON SOLO™**

**12 ECOPHON SOLO™ PRODUCT RANGE**

- 14 Solo Square
- 14 Solo Rectangle Line
- 15 Solo Rectangle
- 16 Solo Circle
- 17 Solo Circle XL
- 18 Solo Textile
- 18 Solo Freedom
- 19 Solo Cloud
- 19 Solo Ellipse
- 20 Solo Triangle
- 20 Solo Pentagon
- 21 Solo Hexagon
- 21 Solo Baffle
- 22 Solo Baffle Wave
- 22 Solo Baffle ZigZag
- 23 Solo Baffle Wall
- 23 Solo Matrix

**24 INSTALLATION METHODS**

**26 ECOPHON SOLO™ OVERVIEW**

**30 COLOURS AND SURFACES**

**32 SYSTEM PROPERTIES**

Acoustics, technical properties  
and installation diagrams

**CONTACT US**

**Saint-Gobain Ecophon UK**

Saint-Gobain Ecophon, Monk Sherborne Road,  
Ramsdell, Tadley, RG26 5PP  
[www.ecophon.com/uk](http://www.ecophon.com/uk)

Tel: 01256 850977 Fax: 01256 851550 E: [info@ecophon.co.uk](mailto:info@ecophon.co.uk)

Sales office, or order and stock information:

Tel: 01256 855220 Fax: 01256 850600 E: [sales.office@ecophon.co.uk](mailto:sales.office@ecophon.co.uk)

Technical Support

Tel: 01256 855250 E: [technical@ecophon.co.uk](mailto:technical@ecophon.co.uk)





04





# A SOUND EFFECT

ON PEOPLE

05

Saint-Gobain Ecophon contributes to good indoor environments for working, healing and learning. We do this by developing, manufacturing and delivering acoustic products and systems designed around the natural evolution of human hearing – replicating the outdoor sound experience indoors, because that’s just better for people.

Having a sound effect on people, in every way we can, is what we do proudly. That promise makes every one of us a passionate advocate for the importance of room acoustics to people’s wellbeing – whatever the space, activity or need.

# GOOD ACOUSTICS MATTER EVERYWHERE

06

The importance of acoustics is underappreciated. Sound impacts us in daily life, and the scientific support for improving our indoor sound environments is well-documented.

And what exactly is an ideal indoor sound environment for people? One based on how we experience sound outside. The human auditory sense is naturally adapted to an outdoor environment where there is not any sound reflections from ceilings and walls.

That's why most of what we do at Ecophon is about replicating the acoustic qualities found in nature for indoor environments. We want to optimise indoor spaces to our natural way of hearing, so that speech and sound is easy to hear and understand, when needed, improving performance and wellbeing.

Usually that starts with the ceiling. A wall-to-wall acoustic ceiling is the easiest way to get a large sound-absorbing surface area into a space, and is usually the best way to reduce sound strength, shorten reverberation times, and increase speech clarity and overall hearing comfort.









TOWARDS

# NET-ZERO ACOUSTICS

Sustainability is more than a word – it's a collective movement to protect people, and the planet, that requires honest commitment and genuine care. That's why Ecophon is building on better materials, transparency, and principles, to name just a few.

We actively support an industry-wide drive to standardised, easy-access Environmental Product Declarations for individual products, rather than product families. Their inclusion of full lifecycle data, from raw material sourcing to end of life, rather than only the favourable stages. A move away from self-declared labels, or non-independently verified sustainability claims. Any promises of net zero carbon emission targets to be validated by the Science-Based Targets initiative.

If we're going to build a sustainable future, it has to start with an honest approach, high ambition and the best of intentions – to build on better together.



# ECOPHON SOLO™

## EXPERIENCING FREEDOM OF EXPRESSION

The ever on trend Ecophon Solo™ allows freedom of design and opportunity to create striking new expressions. The free-hanging panels are all 40 mm thick and come in a variety of shapes, colours and sizes you need to fulfil your artistic ideas.

- Superior acoustic qualities
- Available in a wide range of shapes
- Freedom of design with numerous colours, sizes and surface choices

Solo is well-suited to projects where a wall-to-wall solution is not an option, undesired or in need of improvement. Think lobbies, atriums, historic buildings, restaurants or shopping centres, among others. Hanging Ecophon Solo units directly over work areas, receptions and information counters, as well as other strategic points throughout the space, can improve speech, hearing and acoustic comfort considerably.



Minimum

**57%**

POST-CONSUMER  
RECYCLED CONTENT

## ECOPHON SOLO™ PRODUCT RANGE

With Solo you can choose between a variety of shapes, sizes and colours, create your own unique Solo shape with Solo Freedom or explore the design features of Solo Textile.

Hanging from the ceiling, baffles can be used to form distinct lines, rolling waves or zig-zaggy patterns. Mounted on walls, they add interesting contours and depth to any space. It is just as easy to mount as it is pleasing to look at.

Add perfection to your free hanging installation by using Solo Matrix where the grid offers precision but keeps the floating, free hanging impression.

Industry-low

CO<sub>2</sub>

WITH EXCEPTIONAL RAW MATERIALS AND WIDE USE OF RENEWABLE ENERGIES

### SOLO SQUARE

1200x1200x40



### SOLO RECTANGLE

1800x1200x40

2400x600x40

2400x1200x40

3000x1200x40

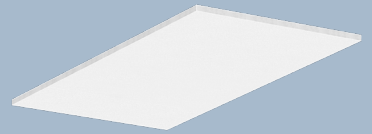

### SOLO CIRCLE

Ø 800x40

Ø 1200x40



### SOLO CIRCLE XL

Ø 1600x40



### SOLO FREEDOM

≤ 2400x1200x40



### SOLO CLOUD

1200x553x40

2400x1106x40



---

**SOLO ELLIPSE**

2400x1000x40



---

**SOLO TRIANGLE**

1039x1200x40



---

**SOLO PENTAGON**

1139x1198x40



---

**SOLO HEXAGON**

1040x1200x40



---

**SOLO BAFFLE**

1200x200x40

1200x300x40

1200x600x40

1800x200x40

1800x300x40

1800x600x40

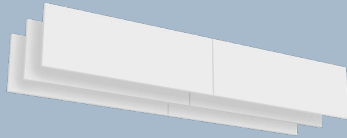

---

**SOLO BAFFLE WAVE**

1800x300x40

1800x600x40



---

**SOLO BAFFLE ZIGZAG**

1800x300x40

1800x600x40



---

**SOLO BAFFLE WALL**

1200x200x40

1200x300x40



---

**SOLO MATRIX**

MODULES:

600x1200x40

600x2400x40

1200x1200x40

2400x1200x40

ROWS:

600x1040x40

1200x1040x40

2400x1040x40

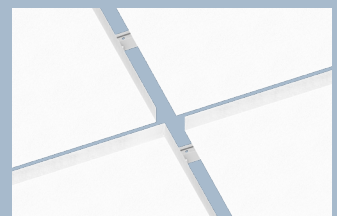

---

**SOLO RECTANGLE LINE**

2400x1200x40

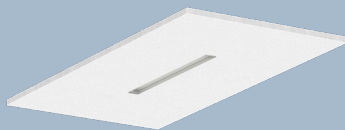

---

**SOLO TEXTILE**

1200x1200x40

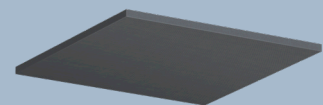



**SOLO SQUARE**

Design possibilities with colours and three different suspension systems to choose from.



**SOLO RECTANGLE LINE**

Integrated recessed luminaire with high level of output, giving a distinctive expression.





**SOLO RECTANGLE**

Design possibilities with large sizes and colours. Three different suspension systems to choose from.





**SOLO CIRCLE**

Design possibilities with colours and three different suspension systems to choose from.





**SOLO CIRCLE XL**

Design possibilities with colours. A large Circle consisting of two semicircles.





**SOLO TEXTILE**

A panel with elegance, fully covered in textile. Available in various colours.



**SOLO FREEDOM**

Custom shaped panels, design possibilities with colours





### SOLO CLOUD

Design possibilities with colours and two standard sizes to chose from.



### SOLO ELLIPSE

Design possibilities with colours.





### SOLO TRIANGLE

Design possibilities with colours.



### SOLO PENTAGON

Design possibilities with colours.





### SOLO HEXAGON

Design possibilities with colours.



### SOLO BAFFLE

Design possibilities with colours and different sizes in a vertical installation.





### SOLO BAFFLE WAVE

A baffle shaped like a wave, design possibilities with colours.



### SOLO BAFFLE ZIGZAG

A baffle shaped like zigzag, design possibilities with colours.





### SOLO BAFFLE WALL

Wall installation with design possibilities in different colours, add depths to any space.



### SOLO MATRIX

A vast range of design possibilities. Each panel has a built in hatch function, and can easily be demounted.



## INSTALLATION METHODS

Ecophon Solo offers a variety of mounting methods to meet market requirements for different installations, both for wall and ceiling.

Enjoy freedom of expression with a variety of installation styles.

## ECOPHON E-TOOLS

Useful tools and services are available on our website for the different phases of the building process, from inspiration to specific maintenance instructions for your Ecophon products.

Read more and try our E-tools at:  
[www.ecophon.com/uk](http://www.ecophon.com/uk)

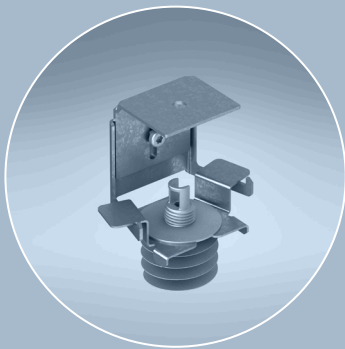

**DIRECT INSTALLATION** close to the soffit with Connect Absorber Bracket and Connect Absorber Anchor.

The brackets are available in adjustable lengths of 50-70 mm and 70-90 mm.



**SUSPENDED WIRE INSTALLATION** with Connect Adjustable Wire Hanger.

Suspended wire mounting can also be done with an angle of up to 45° and in multi-levels.

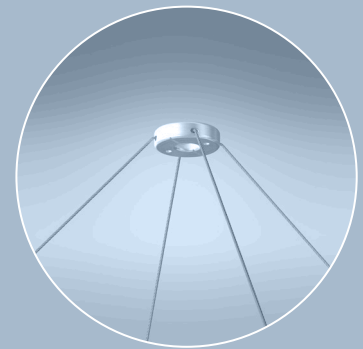

**CONNECT ONE-POINT FIXING** with Connect Absorber Anchor and Connect Adjustable Wire Hanger.

The installation has a discrete design and reduces the amount of fixations in the soffit.



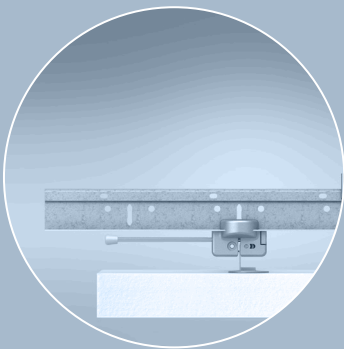

**SOLO MATRIX INSTALLATION** can be done in modules or rows with Connect grid system. The pre-installed anchors and click-in connection to the grid system gives a free hanging design with the accuracy of a grid system.

The Connect Nonius Hangers is available in a range of different lengths.

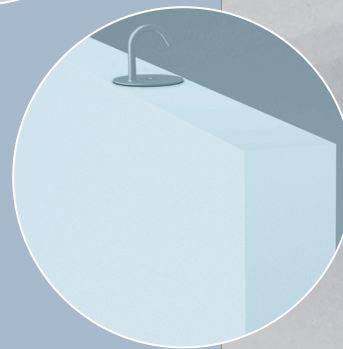
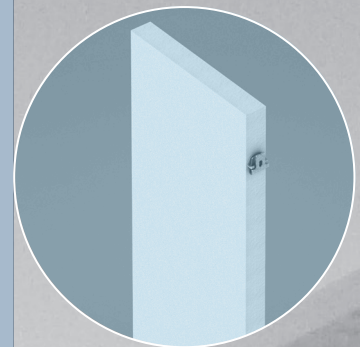
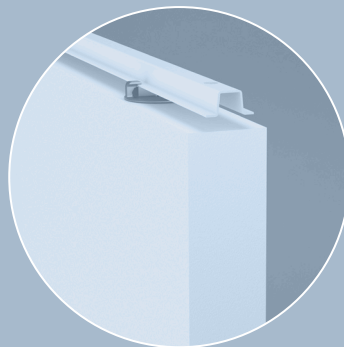



**BAFFLE INSTALLATION** can be done as direct installation using Solo Baffle Anchor and Connect Baffle Profiles or Connect Baffle Wall Fixing.





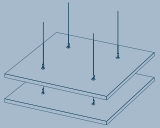
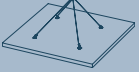
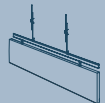
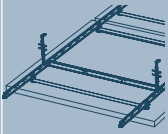

For suspended mounting Connect Adjustable Wire Hanger or Connect grid system can be used with Solo Baffle Hook.

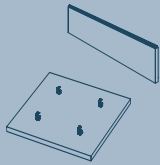
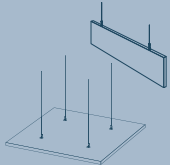
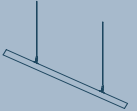

# ECOPHON SOLO OVERVIEW

SHAPE	PRODUCT	SIZE (MM)	INSTALLATION METHODS		
			DIRECT	SUSPENDED WITH WIRE	SUSPENDED WITH WIRE, ANGLE $\leq 45^\circ$
	Ecophon Solo Square	1200x1200x40	•	•	•
	Ecophon Solo Rectangle	2400x600x40	•	•	•
		1800x1200x40	•	•	•
		2400x1200x40	•	•	•
		3000x1200x40		•	
	Ecophon Solo Rectangle Line	2400x1200x40		•	
	Ecophon Solo Matrix (Modules)	600x1200x40			
		600x2400x40			
		1200x1200x40			
		2400x1200x40			
	Ecophon Solo Matrix (Rows)	600x1040x40			
		1200x1040x40			
		2400x1040x40			
	Ecophon Solo Circle	Ø 800x40	•	•	•
		Ø 1200x40	•	•	•
	Ecophon Solo Circle XL	Ø 1600x40		•	
	Ecophon Solo Freedom	$\leq 2400 \times 1200 \times 40$	•	•	•
	Ecophon Solo Cloud	1200x553x40	•	•	•
		2400x1106x40	•	•	•
	Ecophon Solo Ellipse	2400x1000x40	•	•	•
	Ecophon Solo Triangle	1039x1200x40	•	•	•
	Ecophon Solo Pentagon	1139x1198x40	•	•	•
	Ecophon Solo Hexagon	10340x1200x40	•	•	•

SUSPENDED, WITH WIRE, MULTI-LEVEL	SUSPENDED WITH WIRE, ONE- POINT	SUSPENDED WITH CONNECT GRID	SUSPENDED IN CONNECT GRID	WALL	SURFACE
					
•	•				Akutex FT Akutex HS
•					Akutex FT Akutex HS
•					
•	•				
					Akutex FT
			•		Akutex FT
			•		
			•		
			•		
			•		
			•		
			•		
			•		
			•		
					Akutex FT Akutex HS
	•				
					Akutex FT
					Akutex FT
					Akutex FT
					Akutex FT
					Akutex FT
					Akutex FT
					Akutex FT
					Akutex FT
					Akutex FT
					Akutex FT
					Akutex FT
					Akutex FT
					Akutex FT
					Akutex FT
					Akutex FT
					Akutex FT

# ECOPHON SOLO OVERVIEW

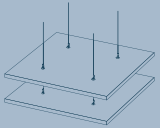
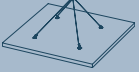
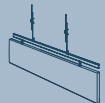
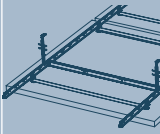
SHAPE	PRODUCT	SIZE (MM)	INSTALLATION METHODS		
			DIRECT	SUSPENDED WITH WIRE	SUSPENDED WITH WIRE, ANGLE $\leq 45^\circ$
					
	Ecophon Solo Baffle	1200x200x40	•	•	
		1200x300x40	•	•	
		1200x600x40	•	•	
		1800x200x40	•	•	
		1800x300x40	•	•	
		1800x600x40	•	•	
	Ecophon Solo Baffle Wave	1800x300/200x40	•	•	
		1800x600/300x40	•	•	
	Ecophon Solo Baffle ZigZag	1800x300/200x40	•	•	
		1800x600/300x40	•	•	
	Ecophon Solo Baffle Wall	1200x200x40			
		1200x300x40			
	Ecophon Solo Textile	1200x1200x40	•	•	

SUSPENDED, WITH WIRE, MULTI-LEVEL	SUSPENDED WITH WIRE, ONE- POINT	SUSPENDED WITH CONNECT GRID	SUSPENDED IN CONNECT GRID	WALL	SURFACE
					
		•			Akutex FT
		•			
		•			
		•			
		•			
		•			Akutex FT
		•			
		•			Akutex FT
		•			
				•	Akutex FT
				•	
					Ecophon Solo Textile

## COLOURS AND SURFACES

### AKUTEX™ FT

The Akutex label guarantees that the product carrying it has a superior surface technology. Our research and development will always focus on visual aspects, acoustic properties, working environment, architectural trends and environmental aspects. This ensures that Akutex is always one step ahead.

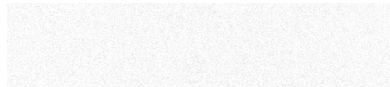

**WHITE FROST**  
Nearest NCS colour sample S 0500-N.  
Light reflectance 85%.



**OCEAN STORM**  
Nearest NCS colour sample S 4020-R90B.  
Light reflectance 24%.

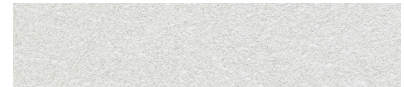

**MORNING DRIZZLE**  
Nearest NCS colour sample S 1002-B.  
Light reflectance 69%.

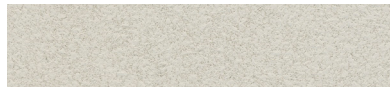

**VOLCANIC ASH**  
Nearest NCS colour sample 2002-Y.  
Light reflectance 56%.



**MOONLIGHT SKY**  
Nearest NCS colour sample S 7020-R90B.  
Light reflectance 7%.

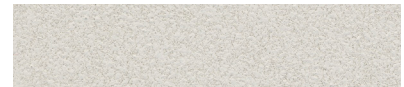

**CLOUDY DAY**  
Nearest NCS colour sample S 1500-N.  
Light reflectance 62%.

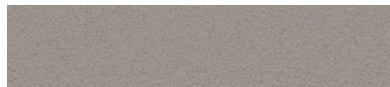

**SILVER STONE**  
Nearest NCS colour sample S 4502-Y.  
Light reflectance 29%.

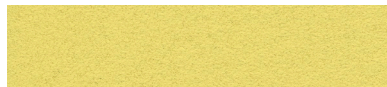

**GOLDEN FIELD**  
Nearest NCS colour sample S 1040-G90Y.  
Light reflectance 61%.

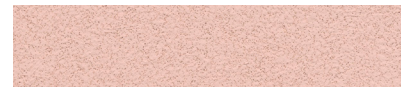

**PEACH ROSE**  
Nearest NCS colour sample S 1515-Y80R.  
Light reflectance 55%.

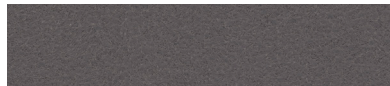

**SILK SLATE**  
Nearest NCS colour sample S 7000-N.  
Light reflectance 13%.



**SUNSET HEAT**  
Nearest NCS colour sample S 2070-Y60R.  
Light reflectance 20%.

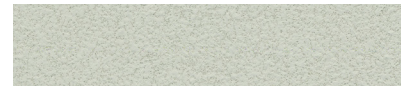

**HIGHLAND FOG**  
Nearest NCS colour sample S 2005-G.  
Light reflectance 55%.

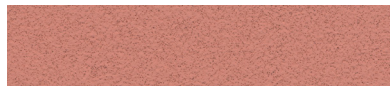

**GOJI BERRY**  
Nearest NCS colour sample S 3030-Y80R.  
Light reflectance 27%.

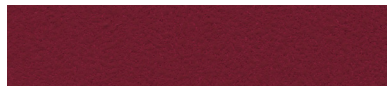

**RUBY ROCK**  
Nearest NCS colour sample S 4050-R10B.  
Light reflectance 7%.



**SAGE GARDEN**  
Nearest NCS colour sample S 3010-B30G.  
Light reflectance 40%.



**SILENT STEAM**  
Nearest NCS colour sample S 2010-B.  
Light reflectance 45%.

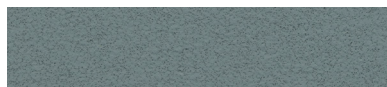

**EUCALYPTUS LEAF**  
Nearest NCS colour sample S 5010-B30G.  
Light reflectance 23%.



**FRESH CLOVER**  
Nearest NCS colour sample S 3020-G40Y.  
Light reflectance 35%.

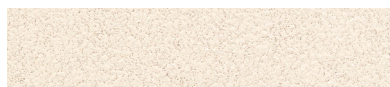

**SCALLOP SHELLS**  
Nearest NCS colour sample S 0804-Y50R.  
Light reflectance 76%.



**SUMMER FOREST**  
Nearest NCS colour sample S 6030-G10Y.  
Light reflectance 10%.

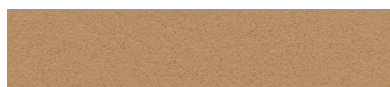

**WET SAND**  
Nearest NCS colour sample S 3020-Y30R.  
Light reflectance 35%.



**DARK DIAMOND**  
Nearest NCS colour sample S 9000-N.  
Light reflectance 4%.

#### NOTE

Colours may vary slightly between different production batches. Reproduction of colours vary between print and reality.

## AKUTEX™ HS

Akutex™ HS is a painted, stain-protected surface for Hygiene applications where there are high demands for wet cleaning. The surface has a high resistance to water and the most common detergents and disinfectants.

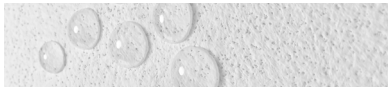

### WHITE 500

Nearest NCS colour sample S 0500-N.  
Light reflectance 84%.

## ECOPHON TEXTILE

Ecophon Textile gives you the ability to create good acoustics that look both understated and eye catching. The subtle pattern is made from a high-quality knitted material using the pique technique. It's characterised by a texture of fine ribbing, giving it a soft glow when light shines on the surface.



### PEACEFUL

Nearest NCS colour sample S 3010-G80Y.  
Light reflectance 37%.

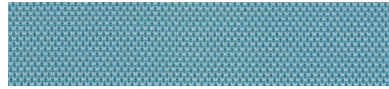

### CURIOUS

Nearest NCS colour sample S 3030-B.  
Light reflectance 29%.



### CONFIDENT

Nearest NCS colour sample S 6020-R90B.  
Light reflectance 9%.



### GENUINE

Nearest NCS colour sample S 7005-R80B.  
Light reflectance 10%.



### FEARLESS

Nearest NCS colour sample S 9000-N.  
Light reflectance 2%.

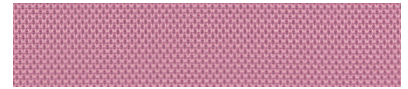

### PASSIONATE

Nearest NCS colour sample S 2030-R20B.  
Light reflectance 33%.

Acoustic ceiling products is amongst the largest surface in a room. It will affect not only the entire look and feel of the interior, but also the end-users' wellbeing. Ecophon has developed different types of surfaces and in different colours to suit most types of environments.

### NOTE

Limited colour variation may occur between batches.

Ecophon Textile fabrics have been designed for long durability, regular dusting according to Ecophon specifications and limited exposure to direct UVs are recommended to increase the lifespan of the products. Reproduction of colours vary between print and reality.



32



# SYSTEM

## PROPERTIES

### ACOUSTICS, TECHNICAL PROPERTIES AND INSTALLATION DIAGRAMS

- 34 Solo Square
- 36 Solo Rectangle
- 38 Solo Circle
- 40 Solo Circle XL
- 42 Solo Cloud
- 43 Solo Triangle
- 45 Solo Pentagon
- 47 Solo Ellipse
- 49 Solo Hexagon
- 51 Solo Baffle Wall
- 52 Solo Baffle
- 54 Solo Baffle Wave
- 56 Solo Baffle ZigZag
- 58 Solo Matrix
- 60 Solo Textile



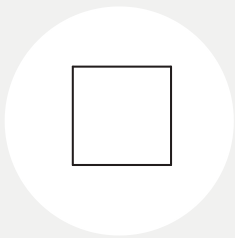

# Ecophon Solo™ Square

**Acoustic:** The values in the diagram refer to a single unit. If the units are arranged in a cluster with distances between units less than 0,5 meters, the Aeq per unit will be slightly reduced.

**Sound Absorption:**

Test results according to EN ISO 354.

A<sub>eq</sub> Equivalent absorption area per unit (m<sup>2</sup> sabin)

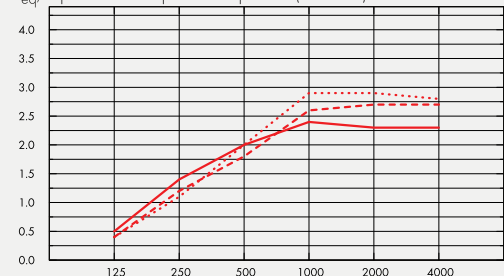

- Solo Square 1200x1200, 200 mm o.d.s.
  - - - Solo Square 1200x1200, 400 mm o.d.s.
  - ... Solo Square 1200x1200, 1000 mm o.d.s.
- o.d.s = overall depth of system

THK mm	o.d.s. mm	A <sub>eq</sub> Equivalent absorption area per unit (m <sup>2</sup> sabin)					
		125 Hz	250 Hz	500 Hz	1000 Hz	2000 Hz	4000 Hz
40	200	0.5	1.4	2.0	2.4	2.3	2.3
40	400	0.4	1.2	1.8	2.6	2.7	2.7
40	1000	0.4	1.1	2.0	2.9	2.9	2.8

**Indoor Air Quality:**

Certificate / Label	Plant
Eurofins Indoor Air Comfort®	IAC IAC Gold
French VOC	A A+
Finnish M1	• •

**Environmental Footprint:** Life-cycle stages A1 to C4 from EPD, in conformity with ISO 14025 / EN 15804

	kg CO <sub>2</sub> equiv/m <sup>2</sup>
Solo Square	9,37
Solo Square/Plant	5,21

**Circularity:** Minimum post-consumer recycled content: 57%, Recyclability: Fully recyclable,

**Fire safety:** The glass wool core of the tiles is tested and classified as non-combustible according to EN ISO 1182. Europe: Solo panel is tested to fire standard EN 13501-1 and classed A2-s1,d0

**Humidity Resistance:** According to EN 13964:2014 Standard: Class C, RH 95% and 30°C, Plant: Class A, RH 70% and 25°C,

**Visual appearance:** White Frost, nearest NCS colour sample S 0500-N, 85% light reflectance. Gloss < 1.

**Cleanability:** Daily dusting and vacuum cleaning. Weekly wet wiping.

**Accessibility:** The tiles are demountable.

**Installation:** Installed according to installation diagrams, installation guides and drawing aid. For information regarding minimum overall depth of system see quantity specification.

**System weight:** Approximately 6.5 kg (4.5 kg/m<sup>2</sup>).

**Mechanical properties:** The tile can take both point loads and distributed loads. See Functional demands, Mechanical properties at [www.ecophon.com](http://www.ecophon.com).

**CE:** Ecophon ceiling systems are CE marked according to the European harmonized standard EN13964:2014. CE marked construction products are covered by a Declaration of Performance (DOP) which enables customers and users to easily compare performance of products available on the European market.

### Installation diagram in detail [www.ecophon.com](http://www.ecophon.com)

---

#### M402

Installation diagram (M402) for Ecophon Solo Square

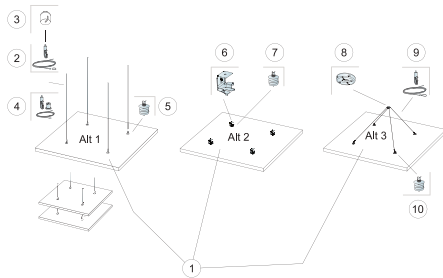

#### M507

Installation diagram (M507) for Ecophon Solo Square Kit

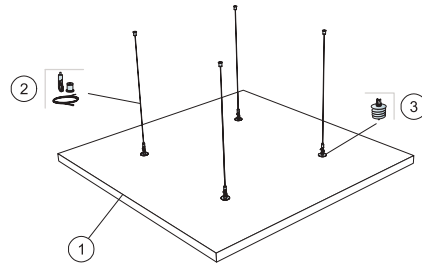

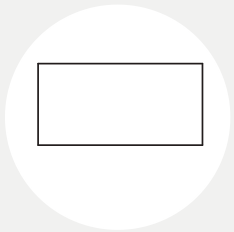

# Ecophon Solo™ Rectangle

**Acoustic:** The values in the diagram refer to a single unit. If the units are arranged in a cluster with distances between units less than 0,5 meters, the Aeq per unit will be slightly reduced.

**Sound Absorption:**

Test results according to EN ISO 354.

A<sub>eq</sub>, Equivalent absorption area per unit (m<sup>2</sup> sabin)

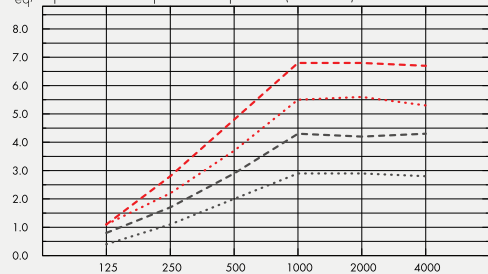

- ..... Solo Rectangle 2400x1200, 1000 mm o.d.s.
  - Solo Rectangle 1800x1200, 1000 mm o.d.s.
  - ..... Solo Rectangle 2400x600, 1000 mm o.d.s.
  - Solo Rectangle 3000x1200, 1000 mm o.d.s.
- o.d.s = overall depth of system

	THK mm	o.d.s. mm	A <sub>eq</sub> , Equivalent absorption area per unit (m <sup>2</sup> sabin)					
			125 Hz	250 Hz	500 Hz	1000 Hz	2000 Hz	4000 Hz
2400x1200	40	200	1.3	2.8	3.5	4.1	4.1	3.9
2400x1200	40	400	1.2	2.4	3.3	4.7	4.9	4.7
2400x1200	40	1000	1.1	2.2	3.7	5.5	5.6	5.3
1800x1200	40	200	0.6	2.0	2.9	3.4	3.3	3.1
1800x1200	40	400	0.8	1.9	2.6	3.7	3.7	3.6
1800x1200	40	1000	0.8	1.7	2.9	4.3	4.2	4.3
2400x600	40	200	0.5	1.4	2.0	2.4	2.3	2.3
2400x600	40	400	0.4	1.2	1.8	2.6	2.7	2.7
2400x600	40	1000	0.4	1.1	2.0	2.9	2.9	2.8
3000x1200	40	200	1.1	3.3	4.4	5.1	5.1	5.0
3000x1200	40	400	1.2	3.0	4.2	5.8	5.8	5.7
3000x1200	40	1000	1.1	2.8	4.8	6.8	6.8	6.7

**Indoor Air Quality:**

Certificate / Label	Plant
Eurofins Indoor Air Comfort®	IAC IAC Gold
French VOC	A A+
Finnish M1	• •

**Environmental Footprint:** Life-cycle stages A1 to C4 from EPD, in conformity with ISO 14025 / EN 15804

	kg CO <sub>2</sub> equiv/m <sup>2</sup>
Solo Rectangle	9,12
Solo Rectangle/Plant	5,32

**Circularity:** Minimum post-consumer recycled content: 57%, Recyclability: Fully recyclable,

**Fire safety:** The glass wool core of the tiles is tested and classified as non-combustible according to EN ISO 1182. Europe: Solo panel is tested to fire standard EN 13501-1 and classed A2-s1,d0

**Humidity Resistance:** According to EN 13964:2014 Standard: Class C, RH 95% and 30°C, Plant: Class A, RH 70% and 25°C,

**Visual appearance:** White Frost, nearest NCS colour sample S 0500-N, 85% light reflectance. Gloss < 1.

**Cleanability:** Daily dusting and vacuum cleaning. Weekly wet wiping.

**Accessibility:** The tiles are demountable.

**Installation:** Installed according to installation diagrams, installation guides and drawing aid. For information regarding minimum overall depth of system see quantity specification.

**System weight:** Approximately 6,5-17,5 kg.

**Mechanical properties:** The tile can take both point loads and distributed loads. See Functional demands, Mechanical properties at [www.ecophon.com](http://www.ecophon.com).

**CE:** Ecophon ceiling systems are CE marked according to the European harmonized standard EN13964:2014. CE marked construction products are covered by a Declaration of Performance (DOP) which enables customers and users to easily compare performance of products available on the European market.

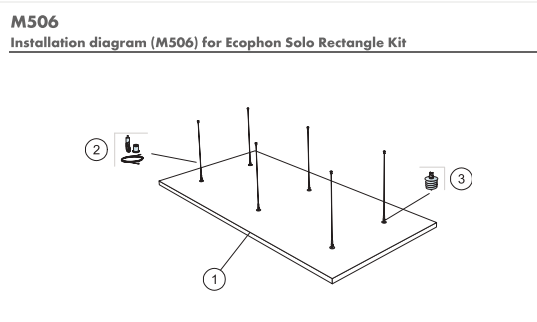
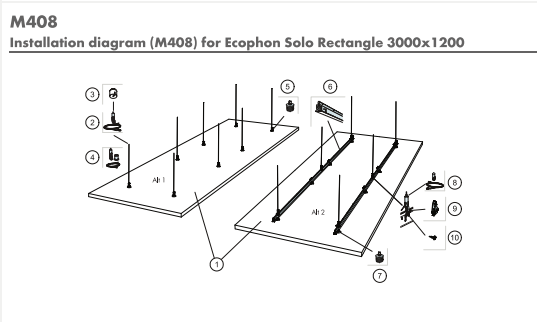
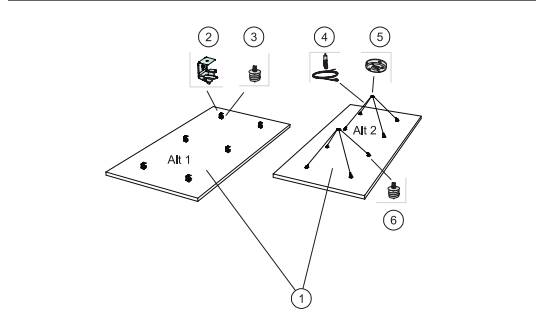
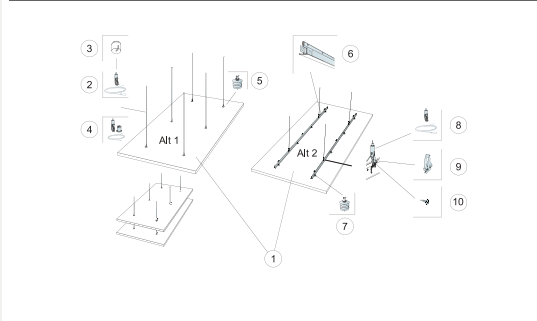
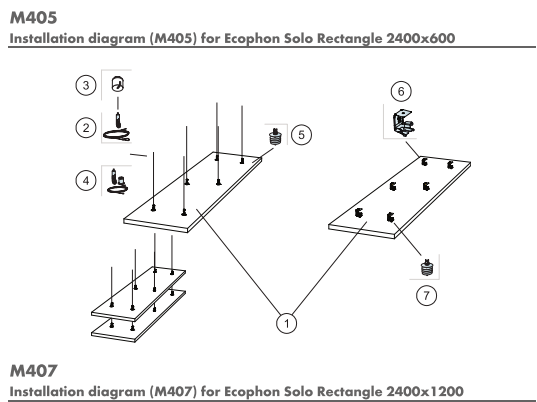
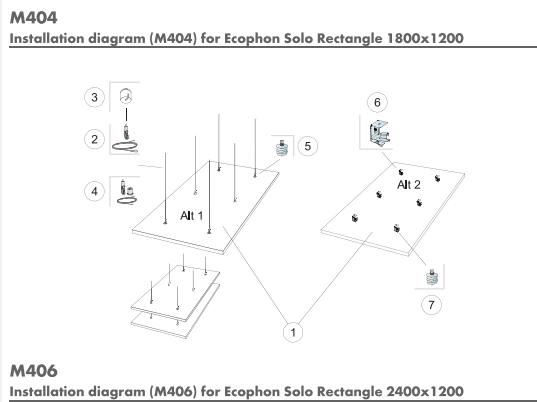

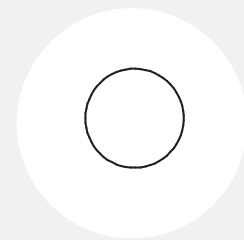

# Ecophon Solo™ Circle

**Acoustic:** The values in the diagram refer to a single unit. If the units are arranged in a cluster with distances between units less than 0,5 meters, the Aeq per unit will be slightly reduced.

**Sound Absorption:**

Test results according to EN ISO 354.

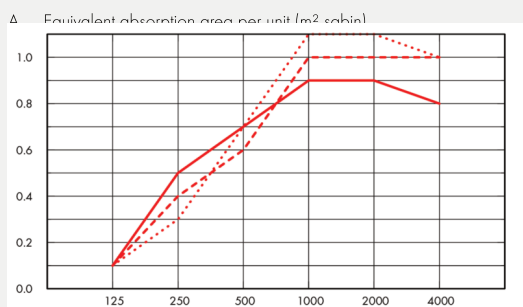

- Solo Circle Ø800, 200 mm o.d.s.
  - - Solo Circle Ø800, 400 mm o.d.s.
  - ... Solo Circle Ø800, 1000 mm o.d.s.
- o.d.s = overall depth of system

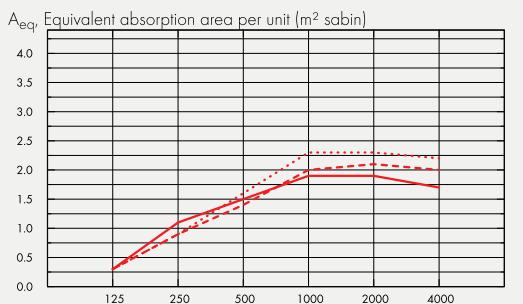

- Solo Circle Ø1200, 200 mm o.d.s.
  - - Solo Circle Ø1200, 400 mm o.d.s.
  - ... Solo Circle Ø1200, 1000 mm o.d.s.
- o.d.s = overall depth of system

38

	THK mm	o.d.s. mm	A <sub>eq</sub> Equivalent absorption area per unit (m <sup>2</sup> sabin)					
			125 Hz	250 Hz	500 Hz	1000 Hz	2000 Hz	4000 Hz
Ø800	40	200	0.1	0.5	0.7	0.9	0.9	0.8
Ø800	40	400	0.1	0.4	0.6	1.0	1.0	1.0
Ø800	40	1000	0.1	0.3	0.7	1.1	1.1	1.0

	THK mm	o.d.s. mm	A <sub>eq</sub> Equivalent absorption area per unit (m <sup>2</sup> sabin)					
			125 Hz	250 Hz	500 Hz	1000 Hz	2000 Hz	4000 Hz
Ø1200	40	200	0.3	1.1	1.5	1.9	1.9	1.7
Ø1200	40	400	0.3	0.9	1.4	2.0	2.1	2.0
Ø1200	40	1000	0.3	0.9	1.6	2.3	2.3	2.2

**Indoor Air Quality:**

Certificate / Label	Plant
Eurofins Indoor Air Comfort®	IAC IAC Gold
French VOC	A A+
Finnish M1	• •

**Environmental Footprint:** Life-cycle stages A1 to C4 from EPD, in conformity with ISO 14025 / EN 15804

	kg CO <sub>2</sub> equiv/m <sup>2</sup>
Solo Circle	10,35
Solo Circle/Plant	5,21

**Circularity:** Minimum post-consumer recycled content: 57%, Recyclability: Fully recyclable,

**Fire safety:** The glass wool core of the tiles is tested and classified as non-combustible according to EN ISO 1182. Europe: Solo panel is tested to fire standard EN 13501-1 and classed A2-s1,d0

**Humidity Resistance:** According to EN 13964:2014 Standard: Class C, RH 95% and 30°C, Plant: Class A, RH 70% and 25°C,

**Visual appearance:** White Frost, nearest NCS colour sample S 0500-N, 85% light reflectance. Gloss < 1.

**Cleanability:** Daily dusting and vacuum cleaning. Weekly wet wiping.

**Accessibility:** The tiles are demountable.

**Installation:** Installed according to installation diagrams, installation guides and drawing aid. For information regarding minimum overall depth of system see quantity specification.

**System weight:** Approximately 2-4,5 kg.

**Mechanical properties:** The tile can take both point loads and distributed loads. See Functional demands, Mechanical properties at [www.ecophon.com](http://www.ecophon.com).

**CE:** Ecophon ceiling systems are CE marked according to the European harmonized standard EN13964:2014. CE marked construction products are covered by a Declaration of Performance (DOP) which enables customers and users to easily compare performance of products available on the European market.

### Installation diagram in detail [www.ecophon.com](http://www.ecophon.com)

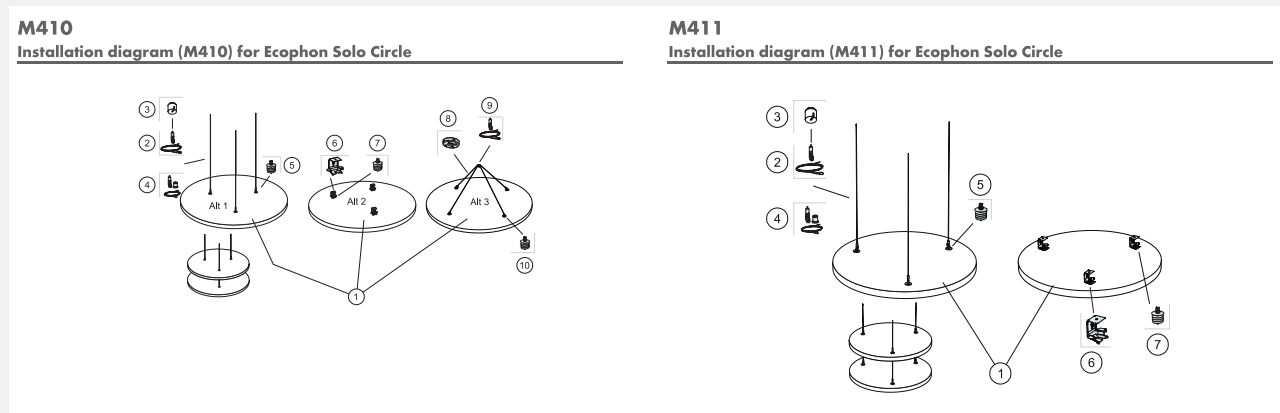

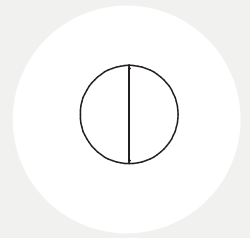

# Ecophon Solo™ Circle XL

**Acoustic:** The values in the diagram refer to a single unit. If the units are arranged in a cluster with distances between units less than 0,5 meters, the Aeq per unit will be slightly reduced.

**Sound Absorption:**

Test results according to EN ISO 354.

A<sub>eq</sub>, Equivalent absorption area per unit (m<sup>2</sup> sabin)

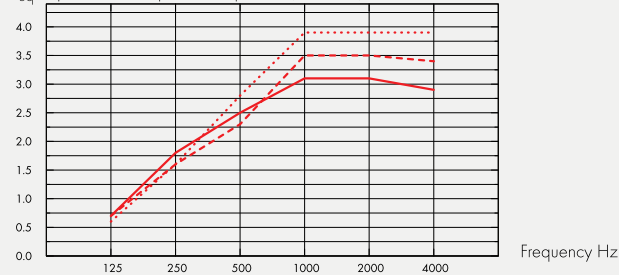

- Solo Circle XL, 200 mm o.d.s.
  - - - Solo Circle XL, 400 mm o.d.s.
  - ... Solo Circle XL, 1000 mm o.d.s.
- o.d.s = overall depth of system

THK mm	o.d.s. mm	A <sub>eq</sub> , Equivalent absorption area per unit (m <sup>2</sup> sabin)					
		125 Hz	250 Hz	500 Hz	1000 Hz	2000 Hz	4000 Hz
40	200	0.7	1.8	2.5	3.1	3.1	2.9
40	400	0.7	1.6	2.3	3.5	3.5	3.4
40	1000	0.6	1.6	2.8	3.9	3.9	3.9

**Indoor Air Quality:**

Certificate / Label	Plant
Eurofins Indoor Air Comfort®	IAC IAC Gold
French VOC	A A+
Finnish M1	• •

**Environmental Footprint:** Life-cycle stages A1 to C4 from EPD, in conformity with ISO 14025 / EN 15804

	kg CO <sub>2</sub> equiv/m <sup>2</sup>
Solo Circle	10,35
Solo Circle/Plant	5,21

**Circularity:** Minimum post-consumer recycled content: 57%, Recyclability: Fully recyclable,

**Fire safety:** The glass wool core of the tiles is tested and classified as non-combustible according to EN ISO 1182. Europe: Solo panel is tested to fire standard EN 13501-1 and classed A2-s1,d0

**Humidity Resistance:** According to EN 13964:2014 Standard: Class C, RH 95% and 30°C, Plant: Class A, RH 70% and 25°C,

**Visual appearance:** White Frost, nearest NCS colour sample S 0500-N, 85% light reflectance. Gloss < 1.

**Cleanability:** Daily dusting and vacuum cleaning. Weekly wet wiping.

**Accessibility:** The tiles are demountable.



**Installation:** Installed according to installation diagrams, installation guides and drawing aid. For information regarding minimum overall depth of system see quantity specification.

**System weight:** Approximately 8 kg.

**Mechanical properties:** No additional live load is allowed.

**CE:** Ecophon ceiling systems are CE marked according to the European harmonized standard EN13964:2014. CE marked construction products are covered by a Declaration of Performance (DOP) which enables customers and users to easily compare performance of products available on the European market.

### Installation diagram in detail [www.ecophon.com](http://www.ecophon.com)

---

#### M290

Installation diagram (M290) for Ecophon Solo Circle XL

---

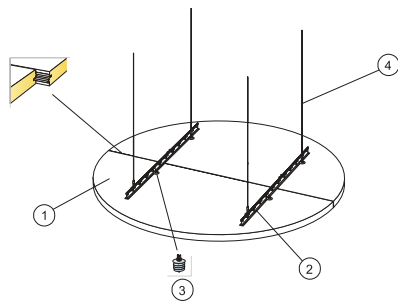

© Ecophon Group



# Ecophon Solo™ Cloud

**Acoustic:** For acoustic data on the panel - please see Solo Rectangle.

## Indoor Air Quality:

Certificate / Label	Plant
Eurofins Indoor Air Comfort®	IAC IAC Gold
French VOC	A A+
Finnish M1	• •

**Environmental Footprint:** Life-cycle stages A1 to C4 from EPD, in conformity with ISO 14025 / EN 15804

	kg CO <sub>2</sub> equiv/m <sup>2</sup>
Solo Freedom	8,41
Solo Freedom/Plant	5,21

**Circularity:** Minimum post-consumer recycled content: 57%, Recyclability: Fully recyclable,

**Fire safety:** The glass wool core of the tiles is tested and classified as non-combustible according to EN ISO 1182. Europe: Solo panel is tested to fire standard EN 13501-1 and classed A2-s1,d0

**Humidity Resistance:** According to EN 13964:2014 Standard: Class C, RH 95% and 30°C, Plant: Class A, RH 70% and 25°C,

**Visual appearance:** White Frost, nearest NCS colour sample S 0500-N, 85% light reflectance. Gloss < 1.

**Cleanability:** Daily dusting and vacuum cleaning. Weekly wet wiping.

**Accessibility:** The tiles are demountable.

**Installation:** Installed according to installation diagrams, installation guides and drawing aid. For information regarding minimum overall depth of system see quantity specification.

**Mechanical properties:** The tile can take both point loads and distributed loads. See Functional demands, Mechanical properties at [www.ecophon.com](http://www.ecophon.com).

**CE:** Ecophon ceiling systems are CE marked according to the European harmonized standard EN13964:2014. CE marked construction products are covered by a Declaration of Performance (DOP) which enables customers and users to easily compare performance of products available on the European market.

### M430

#### Installation diagram (M412) for Ecophon Solo Freedom

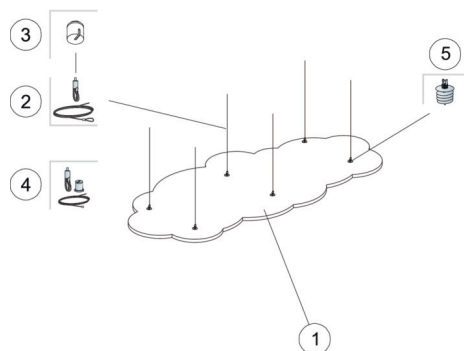



# Ecophon Solo™ Triangle

**Acoustic:** The values in the diagram refer to a single unit. If the units are arranged in a cluster with distances between units less than 0,5 meters, the Aeq per unit will be slightly reduced.

**Sound Absorption:**

Based on test results according to EN ISO 354.

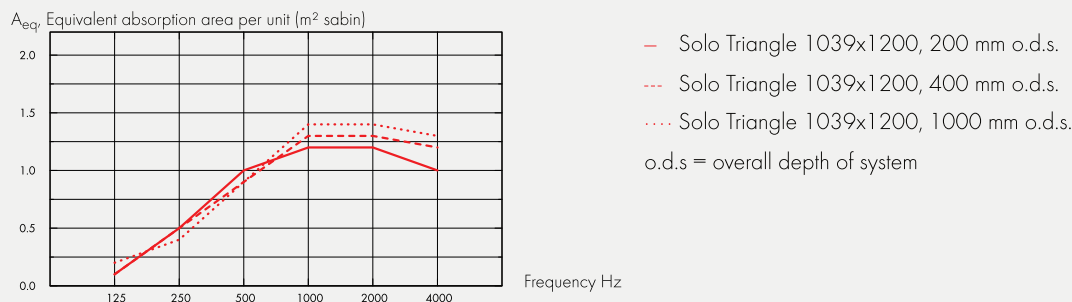

THK mm	o.d.s. mm	A <sub>eq</sub> , Equivalent absorption area per unit (m <sup>2</sup> sabin)					
		125 Hz	250 Hz	500 Hz	1000 Hz	2000 Hz	4000 Hz
40	200	0.1	0.5	1.0	1.2	1.2	1.0
40	400	0.1	0.5	0.9	1.3	1.3	1.2
40	1000	0.2	0.4	0.9	1.4	1.4	1.3

43

**Indoor Air Quality:**

Certificate / Label	Plant
Eurofins Indoor Air Comfort®	IAC IAC Gold
French VOC	A A+
Finnish M1	• •

**Environmental Footprint:** Life-cycle stages A1 to C4 from EPD, in conformity with ISO 14025 / EN 15804

	kg CO <sub>2</sub> equiv/m <sup>2</sup>
Solo Freedom	8,41
Solo Freedom/Plant	5,21

**Circularity:** Minimum post-consumer recycled content: 57%, Recyclability: Fully recyclable,

**Fire safety:** The glass wool core of the tiles is tested and classified as non-combustible according to EN ISO 1182. Europe: Solo panel is tested to fire standard EN 13501-1 and classed A2-s1,d0

**Humidity Resistance:** According to EN 13964:2014 Standard: Class C, RH 95% and 30°C, Plant: Class A, RH 70% and 25°C,

**Visual appearance:** White Frost, nearest NCS colour sample S 0500-N, 85% light reflectance. Gloss < 1.

**Cleanability:** Daily dusting and vacuum cleaning. Weekly wet wiping.

**Accessibility:** The tiles are demountable.

**Installation:** Installed according to installation diagrams, installation guides and drawing aid. For information regarding minimum overall depth of system see quantity specification.

**Mechanical properties:** The tile can take both point loads and distributed loads. See Functional demands, Mechanical properties at [www.ecophon.com](http://www.ecophon.com).

**CE:** Ecophon ceiling systems are CE marked according to the European harmonized standard EN13964:2014. CE marked construction products are covered by a Declaration of Performance (DOP) which enables customers and users to easily compare performance of products available on the European market.

### **Installation diagram in detail [www.ecophon.com](http://www.ecophon.com)**

---

#### **M297**

#### **Installation diagram (M297) for Ecophon Solo Triangle**

---

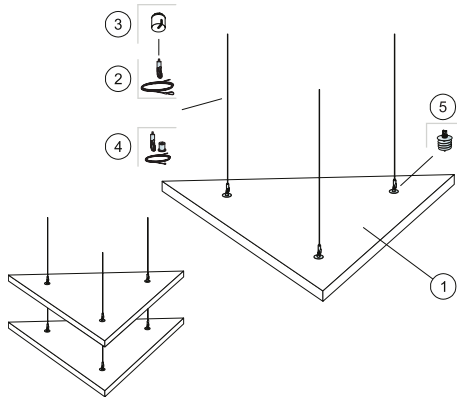



# Ecophon Solo™ Pentagon

**Acoustic:** The values in the diagram refer to a single unit. If the units are arranged in a cluster with distances between units less than 0,5 meters, the Aeq per unit will be slightly reduced.

**Sound Absorption:**

Based on test results according to EN ISO 354.

A<sub>eq</sub> Equivalent absorption area per unit (m<sup>2</sup> sabin)

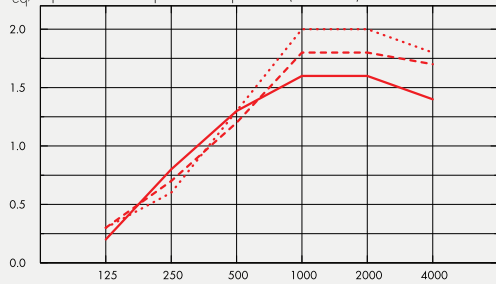

- Solo Pentagon 1139x1198, 200 mm o.d.s.
  - - - Solo Pentagon 1139x1198, 400 mm o.d.s.
  - ... Solo Pentagon 1139x1198, 1000 mm o.d.s.
- o.d.s = overall depth of system

THK mm	o.d.s. mm	A <sub>eq</sub> Equivalent absorption area per unit (m <sup>2</sup> sabin)					
		125 Hz	250 Hz	500 Hz	1000 Hz	2000 Hz	4000 Hz
40	200	0.2	0.8	1.3	1.6	1.6	1.4
40	400	0.3	0.7	1.2	1.8	1.8	1.7
40	1000	0.3	0.6	1.3	2.0	2.0	1.8

45

**Indoor Air Quality:**

Certificate / Label	Plant
Eurofins Indoor Air Comfort®	IAC IAC Gold
French VOC	A A+
Finnish M1	• •

**Environmental Footprint:** Life-cycle stages A1 to C4 from EPD, in conformity with ISO 14025 / EN 15804

	kg CO <sub>2</sub> equiv/m <sup>2</sup>
Solo Freedom	8,41
Solo Freedom/Plant	5,21

**Circularity:** Minimum post-consumer recycled content: 57%, Recyclability: Fully recyclable,

**Fire safety:** The glass wool core of the tiles is tested and classified as non-combustible according to EN ISO 1182. Europe: Solo panel is tested to fire standard EN 13501-1 and classed A2-s1,d0

**Humidity Resistance:** According to EN 13964:2014 Standard: Class C, RH 95% and 30°C, Plant: Class A, RH 70% and 25°C,

**Visual appearance:** White Frost, nearest NCS colour sample S 0500-N, 85% light reflectance. Gloss < 1.

**Cleanability:** Daily dusting and vacuum cleaning. Weekly wet wiping.

**Accessibility:** The tiles are demountable.

**Installation:** Installed according to installation diagrams, installation guides and drawing aid. For information regarding minimum overall depth of system see quantity specification.

**Mechanical properties:** The tile can take both point loads and distributed loads. See Functional demands, Mechanical properties at [www.ecophon.com](http://www.ecophon.com).

**CE:** Ecophon ceiling systems are CE marked according to the European harmonized standard EN13964:2014. CE marked construction products are covered by a Declaration of Performance (DOP) which enables customers and users to easily compare performance of products available on the European market.

### Installation diagram in detail [www.ecophon.com](http://www.ecophon.com)

---

#### M427

#### Installation diagram (M427) for Ecophon Solo Pentagon

---

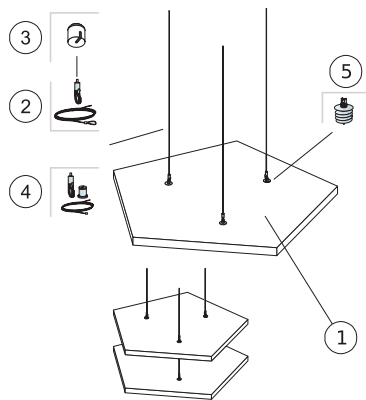

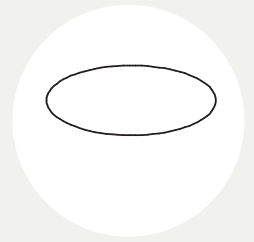

# Ecophon Solo™ Ellipse

**Acoustic:** The values in the diagram refer to a single unit. If the units are arranged in a cluster with distances between units less than 0,5 meters, the Aeq per unit will be slightly reduced.

**Sound Absorption:**

Based on test results according to EN ISO 354.

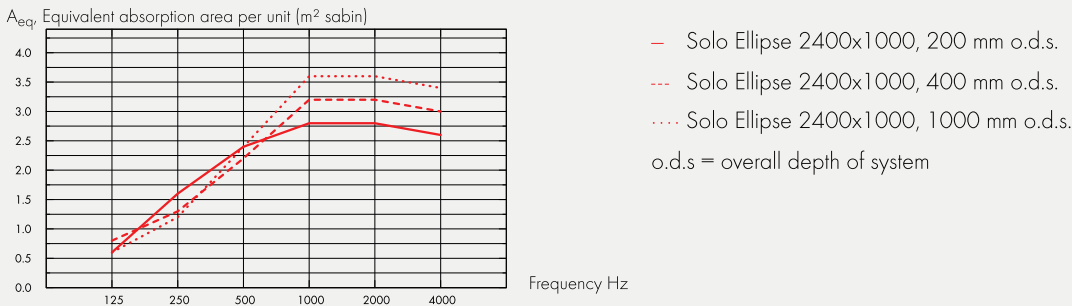

THK mm	o.d.s. mm	A <sub>eq</sub> Equivalent absorption area per unit (m <sup>2</sup> sabin)					
		125 Hz	250 Hz	500 Hz	1000 Hz	2000 Hz	4000 Hz
40	200	0.6	1.6	2.4	2.8	2.8	2.6
40	400	0.8	1.3	2.2	3.2	3.2	3.0
40	1000	0.6	1.2	2.4	3.6	3.6	3.4

**Indoor Air Quality:**

Certificate / Label	Plant
Eurofins Indoor Air Comfort®	IAC IAC Gold
French VOC	A A+
Finnish M1	• •

**Environmental Footprint:** Life-cycle stages A1 to C4 from EPD, in conformity with ISO 14025 / EN 15804

	kg CO <sub>2</sub> equiv/m <sup>2</sup>
Solo Freedom	8,41
Solo Freedom/Plant	5,21

**Circularity:** Minimum post-consumer recycled content: 57%, Recyclability: Fully recyclable,

**Fire safety:** The glass wool core of the tiles is tested and classified as non-combustible according to EN ISO 1182. Europe: Solo panel is tested to fire standard EN 13501-1 and classed A2-s1,d0

**Humidity Resistance:** According to EN 13964:2014 Standard: Class C, RH 95% and 30°C, Plant: Class A, RH 70% and 25°C,

**Visual appearance:** White Frost, nearest NCS colour sample S 0500-N, 85% light reflectance. Gloss < 1.

**Cleanability:** Daily dusting and vacuum cleaning. Weekly wet wiping.

**Accessibility:** The tiles are demountable.

**Installation:** Installed according to installation diagrams, installation guides and drawing aid. For information regarding minimum overall depth of system see quantity specification.

**Mechanical properties:** The tile can take both point loads and distributed loads. See Functional demands, Mechanical properties at [www.ecophon.com](http://www.ecophon.com).

**CE:** Ecophon ceiling systems are CE marked according to the European harmonized standard EN13964:2014. CE marked construction products are covered by a Declaration of Performance (DOP) which enables customers and users to easily compare performance of products available on the European market.

### **Installation diagram in detail [www.ecophon.com](http://www.ecophon.com)**

---

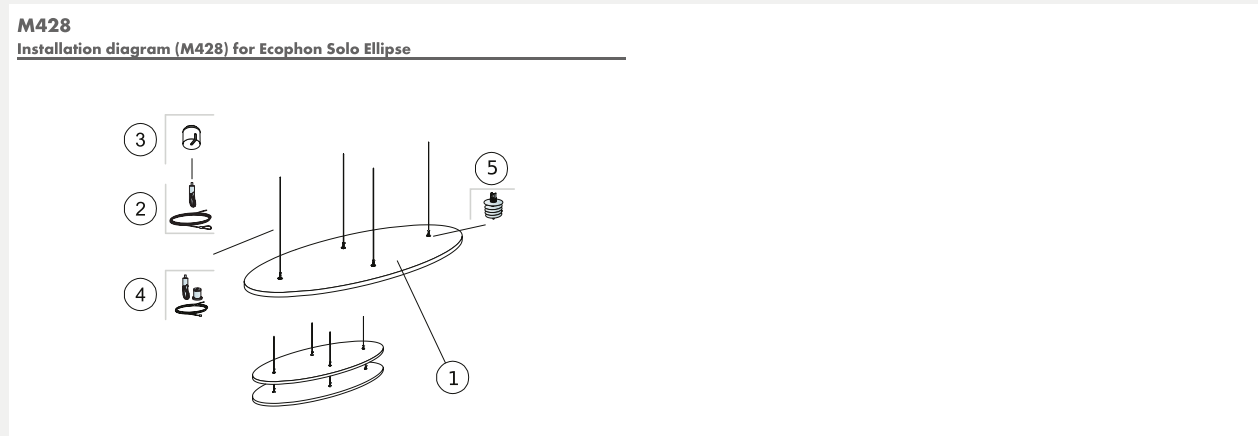





# Ecophon Solo™ Hexagon

**Acoustic:** The values in the diagram refer to a single unit. If the units are arranged in a cluster with distances between units less than 0,5 meters, the Aeq per unit will be slightly reduced.

**Sound Absorption:**

Based on test results according to EN ISO 354.

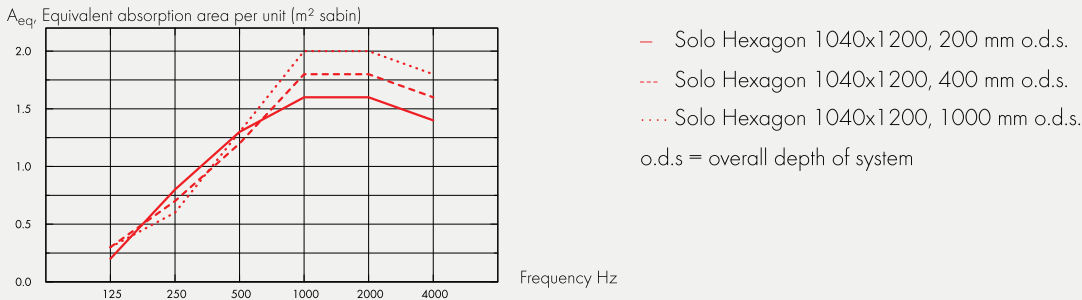

THK mm	o.d.s. mm	A <sub>eq</sub> Equivalent absorption area per unit (m <sup>2</sup> sabin)					
		125 Hz	250 Hz	500 Hz	1000 Hz	2000 Hz	4000 Hz
40	200	0.2	0.8	1.3	1.6	1.6	1.4
40	400	0.3	0.7	1.2	1.8	1.8	1.6
40	1000	0.3	0.6	1.3	2.0	2.0	1.8

**Indoor Air Quality:**

Certificate / Label	Plant
Eurofins Indoor Air Comfort®	IAC IAC Gold
French VOC	A A+
Finnish M1	• •

**Environmental Footprint:** Life-cycle stages A1 to C4 from EPD, in conformity with ISO 14025 / EN 15804

	kg CO <sub>2</sub> equiv/m <sup>2</sup>
Solo Freedom	8,41
Solo Freedom/Plant	5,21

**Circularity:** Minimum post-consumer recycled content: 57%, Recyclability: Fully recyclable,

**Fire safety:** The glass wool core of the tiles is tested and classified as non-combustible according to EN ISO 1182. Europe: Solo panel is tested to fire standard EN 13501-1 and classed A2-s1,d0

**Humidity Resistance:** According to EN 13964:2014 Standard: Class C, RH 95% and 30°C, Plant: Class A, RH 70% and 25°C,

**Visual appearance:** White Frost, nearest NCS colour sample S 0500-N, 85% light reflectance. Gloss < 1.

**Cleanability:** Daily dusting and vacuum cleaning. Weekly wet wiping.

**Accessibility:** The tiles are demountable.

**Installation:** Installed according to installation diagrams, installation guides and drawing aid. For information regarding minimum overall depth of system see quantity specification.

**Mechanical properties:** The tile can take both point loads and distributed loads. See Functional demands, Mechanical properties at [www.ecophon.com](http://www.ecophon.com).

**CE:** Ecophon ceiling systems are CE marked according to the European harmonized standard EN13964:2014. CE marked construction products are covered by a Declaration of Performance (DOP) which enables customers and users to easily compare performance of products available on the European market.

**Installation diagram in detail [www.ecophon.com](http://www.ecophon.com)**

---

**M426**

**Installation diagram (M426) for Ecophon Solo Hexagon**

---

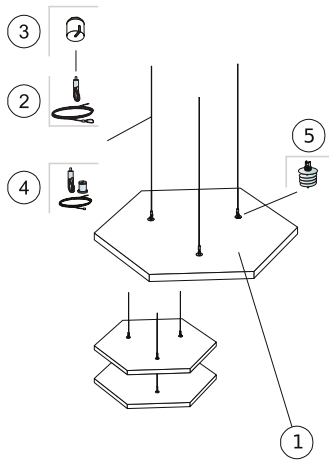

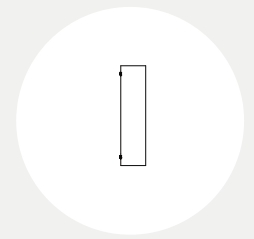

# Ecophon Solo™ Baffle Wall

**Acoustic:** For acoustic data on the panel - please see Solo Baffle.

## Indoor Air Quality:

Certificate / Label

Eurofins Indoor Air Comfort®	IAC
French VOC	A
Finnish M1	•

**Environmental Footprint:** Life-cycle stages A1 to C4 from EPD, in conformity with ISO 14025 / EN 15804

	kg CO <sub>2</sub> equiv/m <sup>2</sup>
Solo Baffle Wall	10,11

**Circularity:** Minimum post-consumer recycled content: 57%, Recyclability: Fully recyclable,

**Fire safety:** The glass wool core of the tiles is tested and classified as non-combustible according to EN ISO 1182. Europe: Solo panel is tested to fire standard EN 13501-1 and classed A2-s1,d0

**Humidity Resistance:** Class C, relative humidity 95% and 30°C, according to EN 13964:2014

**Visual appearance:** White Frost, nearest NCS colour sample S 0500-N, 85% light reflectance. Gloss < 1.

**Cleanability:** Daily dusting and vacuum cleaning. Weekly wet wiping.

**Accessibility:** The tiles are demountable.

**Installation:** Installed according to installation diagrams, installation guides and drawing aid. For information regarding minimum overall depth of system see quantity specification.

**Mechanical properties:** Additional live load has to be fixed to the soffit.

**CE:** Ecophon ceiling systems are CE marked according to the European harmonized standard EN13964:2014. CE marked construction products are covered by a Declaration of Performance (DOP) which enables customers and users to easily compare performance of products available on the European market.

### M420

#### Installation diagram (M420) for Ecophon Solo Baffle Wall

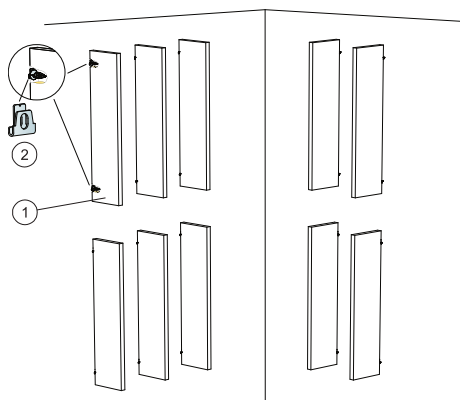

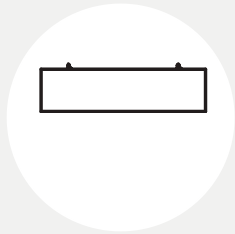

# Ecophon Solo™ Baffle

## Acoustic:

### Sound Absorption:

Test results according to EN ISO 354:2003 NOTE: Results shown are not comparable with results according to older versions of this standard due to discrepancies in test method. Classification according to EN ISO 11654, and the single value ratings for Noise Reduction Coefficient, NRC and Sound Absorption Average, SAA according to ASTM C 423.

$\alpha_p$ , Practical sound absorption coefficient

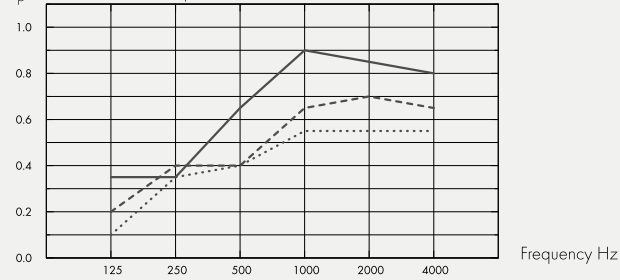

- ..... Solo Baffle 1200/1800x200, spacing 600mm, direct mounting
  - Solo Baffle 1200/1800x300, spacing 600mm, direct mounting
  - Solo Baffle 1200/1800x600, spacing 600mm, direct mounting
- o.d.s = overall depth of system

$A_{eq}$ , Equivalent absorption area per unit (m<sup>2</sup> sabin)

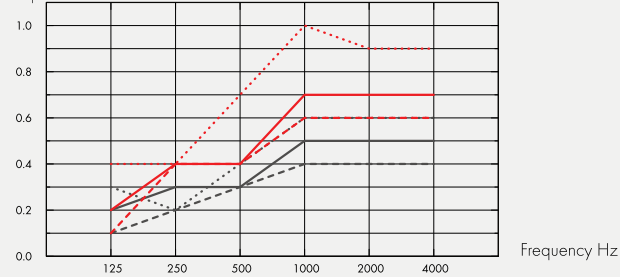

- Solo Baffle 1200x200
  - Solo Baffle 1200x300
  - ..... Solo Baffle 1200x600
  - Solo Baffle 1800x200
  - Solo Baffle 1800x300
  - ..... Solo Baffle 1800x600
- o.d.s = overall depth of system

	THK mm	o.d.s. mm	$\alpha_p$ , Practical sound absorption coefficient						$\alpha_w$
			125 Hz	250 Hz	500 Hz	1000 Hz	2000 Hz	4000 Hz	
c600	40	200	0.10	0.35	0.40	0.55	0.55	0.55	0.50
c600	40	300	0.20	0.40	0.40	0.65	0.70	0.65	0.50
c600	40	600	0.35	0.35	0.65	0.90	0.85	0.80	0.65

	THK mm	o.d.s. mm	$A_{eq}$ , Equivalent absorption area per unit (m <sup>2</sup> sabin)					
			125 Hz	250 Hz	500 Hz	1000 Hz	2000 Hz	4000 Hz
1200x200 c600	40	200	0.1	0.2	0.3	0.4	0.4	0.4
1200x300 c600	40	300	0.2	0.3	0.3	0.5	0.5	0.5
1200x600 c600	40	600	0.3	0.2	0.4	0.6	0.6	0.6
1800x200 c600	40	200	0.1	0.4	0.4	0.6	0.6	0.6
1800x300 c600	40	300	0.2	0.4	0.4	0.7	0.7	0.7
1800x600 c600	40	600	0.4	0.4	0.7	1.0	0.9	0.9

## Indoor Air Quality:

Certificate / Label

Eurofins Indoor Air Comfort®	IAC
French VOC	A
Finnish M1	•

**Environmental Footprint:** Life-cycle stages A1 to C4 from EPD, in conformity with ISO 14025 / EN 15804

	kg CO <sub>2</sub> equiv/m <sup>2</sup>
Solo Baffle	10,11

**Circularity:** Minimum post-consumer recycled content: 57%, Recyclability: Fully recyclable,

**Fire safety:** The glass wool core of the tiles is tested and classified as non-combustible according to EN ISO 1182. Europe: Solo panel is tested to fire standard EN 13501-1 and classed A2-s1,d0

**Humidity Resistance:** Class C, relative humidity 95% and 30°C, according to EN 13964:2014

**Visual appearance:** White Frost, nearest NCS colour sample S 0500-N, 85% light reflectance. Gloss < 1.

**Cleanability:** Daily dusting and vacuum cleaning. Weekly wet wiping.

**Accessibility:** The tiles are demountable.

**Installation:** Installed according to installation diagrams, installation guides and drawing aid. For information regarding minimum overall depth of system see quantity specification.

**System weight:** Approximate weight of system 2-4 kg/m

**Mechanical properties:** Additional live load has to be fixed to the soffit.

**CE:** Ecophon ceiling systems are CE marked according to the European harmonized standard EN13964:2014. CE marked construction products are covered by a Declaration of Performance (DOP) which enables customers and users to easily compare performance of products available on the European market.

## Installation diagram in detail [www.ecophon.com](http://www.ecophon.com)

### M414

Installation diagram (M414) for Ecophon Solo Baffle/Anchor

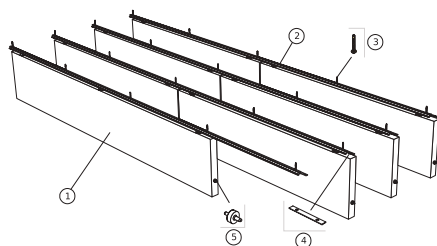

### M491

Installation diagram (M491) for Ecophon Solo Baffle/Hook

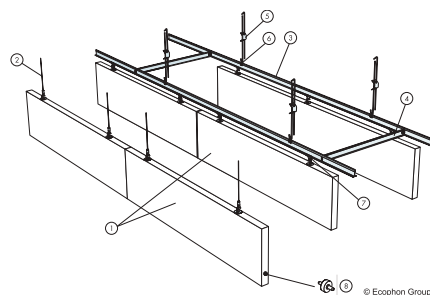

### M563

Installation diagram (M563) for Ecophon Solo Baffle/Anchor

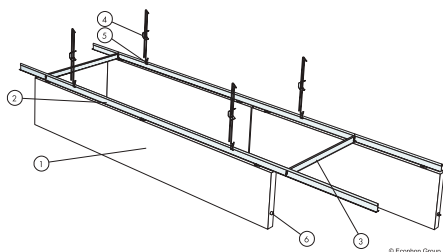

### M580

Installation diagram (M580) for Ecophon Solo Baffle/Hook

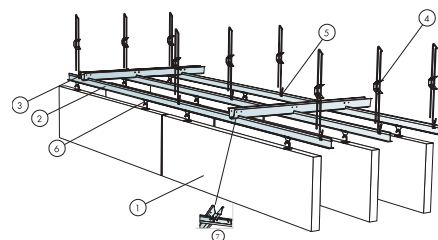

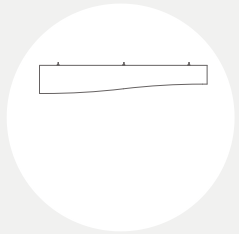

# Ecophon Solo™ Baffle Wave

## Acoustic:

### Sound Absorption:

Test results according to EN ISO 354:2003 NOTE: Results shown are not comparable with results according to older versions of this standard due to discrepancies in test method. Classification according to EN ISO 11654, and the single value ratings for Noise Reduction Coefficient, NRC and Sound Absorption Average, SAA according to ASTM C 423.

$\alpha_p$ , Practical sound absorption coefficient

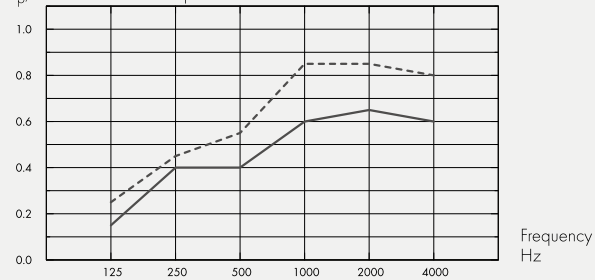

- Solo Baffle Wave 1800x300/200, spacing 600, direct mounting
  - Solo Baffle Wave 1800x600/300, spacing 600, direct mounting
- o.d.s = overall depth of system

$A_{eq}$ , Equivalent absorption area per unit (m<sup>2</sup> sabin)

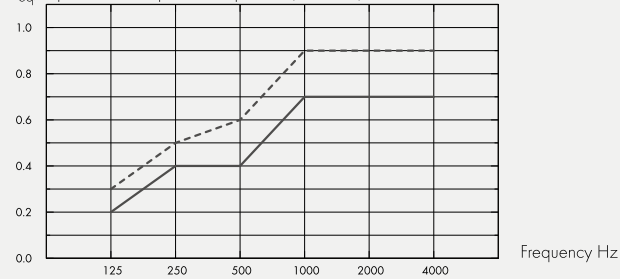

- Solo Baffle Wave 1800x300/200
  - Solo Baffle Wave 1800x600/300
- o.d.s = overall depth of system

	THK mm	o.d.s. mm	$\alpha_p$ , Practical sound absorption coefficient						$\alpha_w$
			125 Hz	250 Hz	500 Hz	1000 Hz	2000 Hz	4000 Hz	
c600	40	300	0.15	0.40	0.40	0.60	0.65	0.60	0.50
c600	40	600	0.25	0.45	0.55	0.85	0.85	0.80	0.65

	THK mm	o.d.s. mm	$A_{eq}$ , Equivalent absorption area per unit (m <sup>2</sup> sabin)					
			125 Hz	250 Hz	500 Hz	1000 Hz	2000 Hz	4000 Hz
c600	40	300	0.2	0.4	0.4	0.7	0.7	0.7
c600	40	600	0.3	0.5	0.6	0.9	0.9	0.9

	THK mm	o.d.s. mm	NRC	SAA
c600	40	300	0.50	0.52
c600	40	600	0.70	0.68

## Indoor Air Quality:

Certificate / Label

Eurofins Indoor Air Comfort®	IAC
French VOC	A
Finnish M1	•

**Environmental Footprint:** Life-cycle stages A1 to C4 from EPD, in conformity with ISO 14025 / EN 15804

	kg CO <sub>2</sub> equiv/m <sup>2</sup>
Solo Baffle Wave	11,07

**Circularity:** Minimum post-consumer recycled content: 57%, Recyclability: Fully recyclable,

**Fire safety:** The glass wool core of the tiles is tested and classified as non-combustible according to EN ISO 1182. Europe: Solo panel is tested to fire standard EN 13501-1 and classed A2-s1,d0

**Humidity Resistance:** Class C, relative humidity 95% and 30°C, according to EN 13964:2014

**Visual appearance:** White Frost, nearest NCS colour sample S 0500-N, 85% light reflectance. Gloss < 1.

**Cleanability:** Daily dusting and vacuum cleaning. Weekly wet wiping.

**Accessibility:** The tiles are demountable.

**Installation:** Installed according to installation diagrams, installation guides and drawing aid. For information regarding minimum overall depth of system see quantity specification.

**System weight:** Approximate weight of system 2-4 kg/m

**Mechanical properties:** Additional live load has to be fixed to the soffit.

**CE:** Ecophon ceiling systems are CE marked according to the European harmonized standard EN13964:2014. CE marked construction products are covered by a Declaration of Performance (DOP) which enables customers and users to easily compare performance of products available on the European market.

**Installation diagram in detail [www.ecophon.com](http://www.ecophon.com)**

55

### M495

Installation diagram (M495) for Ecophon Solo Baffle Wave/Hook

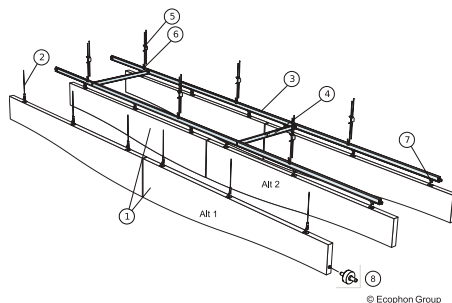

### M419

Installation diagram (M419) for Ecophon Solo Baffle Wave/Anchor

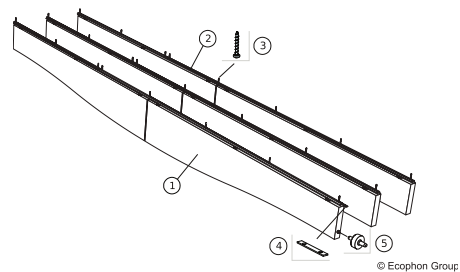

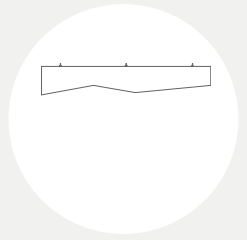

# Ecophon Solo™ Baffle ZigZag

## Acoustic:

### Sound Absorption:

Test results according to EN ISO 354:2003 NOTE: Results shown are not comparable with results according to older versions of this standard due to discrepancies in test method. Classification according to EN ISO 11654, and the single value ratings for Noise Reduction Coefficient, NRC and Sound Absorption Average, SAA according to ASTM C 423.

$\alpha_p$ , Practical sound absorption coefficient

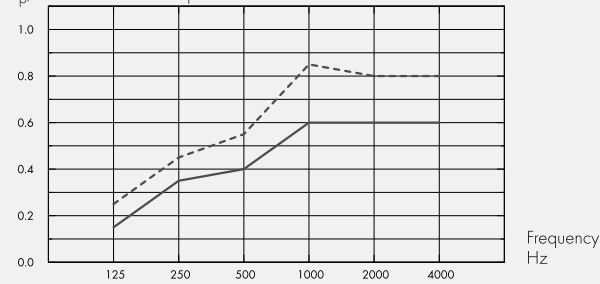

- Solo Baffle ZigZag 1800x300/200, spacing 600, direct mounting
  - Solo Baffle ZigZag 1800x600/300, spacing 600, direct mounting
- o.d.s = overall depth of system

$A_{eq}$ , Equivalent absorption area per unit (m<sup>2</sup> sabin)

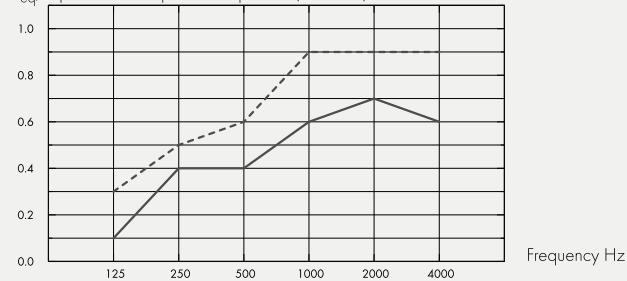

- Solo Baffle ZigZag 1800x300/200
  - Solo Baffle ZigZag 1800x600/300
- o.d.s = overall depth of system

	THK mm	o.d.s. mm	$\alpha_p$ , Practical sound absorption coefficient						$\alpha_w$
			125 Hz	250 Hz	500 Hz	1000 Hz	2000 Hz	4000 Hz	
c600	40	300	0.15	0.35	0.40	0.60	0.60	0.60	0.50
c600	40	600	0.25	0.45	0.55	0.85	0.80	0.80	0.65

	THK mm	o.d.s. mm	$A_{eq}$ , Equivalent absorption area per unit (m <sup>2</sup> sabin)					
			125 Hz	250 Hz	500 Hz	1000 Hz	2000 Hz	4000 Hz
c600	40	300	0.1	0.4	0.4	0.6	0.7	0.6
c600	40	600	0.3	0.5	0.6	0.9	0.9	0.9

	THK mm	o.d.s. mm	NRC	SAA
c600	40	300	0.50	0.49
c600	40	600	0.65	0.65



## Indoor Air Quality:

Certificate / Label

Eurofins Indoor Air Comfort®	IAC
French VOC	A
Finnish M1	•

**Environmental Footprint:** Life-cycle stages A1 to C4 from EPD, in conformity with ISO 14025 / EN 15804

	kg CO <sub>2</sub> equiv/m <sup>2</sup>
Solo Baffle ZigZag	11,13

**Circularity:** Minimum post-consumer recycled content: 57%, Recyclability: Fully recyclable,

**Fire safety:** The glass wool core of the tiles is tested and classified as non-combustible according to EN ISO 1182. Europe: Solo panel is tested to fire standard EN 13501-1 and classed A2-s1,d0

**Humidity Resistance:** Class C, relative humidity 95% and 30°C, according to EN 13964:2014

**Visual appearance:** White Frost, nearest NCS colour sample S 0500-N, 85% light reflectance. Gloss < 1.

**Cleanability:** Daily dusting and vacuum cleaning. Weekly wet wiping.

**Accessibility:** The tiles are demountable.

**Installation:** Installed according to installation diagrams, installation guides and drawing aid. For information regarding minimum overall depth of system see quantity specification.

**System weight:** Approximate weight of system 2-4 kg/m

**Mechanical properties:** Additional live load has to be fixed to the soffit.

**CE:** Ecophon ceiling systems are CE marked according to the European harmonized standard EN13964:2014. CE marked construction products are covered by a Declaration of Performance (DOP) which enables customers and users to easily compare performance of products available on the European market.

## Installation diagram in detail [www.ecophon.com](http://www.ecophon.com)

**M496**  
Installation diagram (M496) for Ecophon Solo Baffle ZigZag/Hook

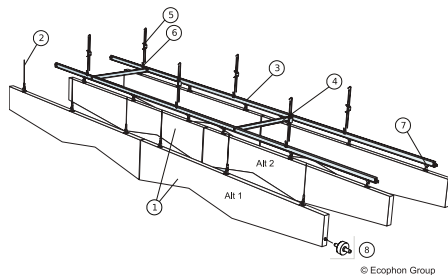

**M417**  
Installation diagram (M417) for Ecophon Solo Baffle Zig Zag

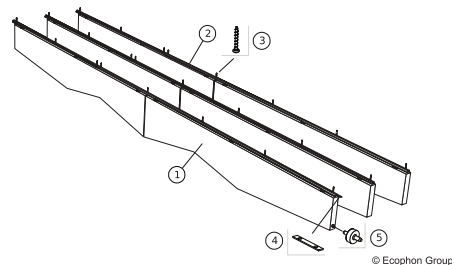

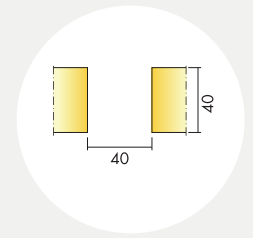

# Ecophon Solo™ Matrix

**Acoustic:** The first diagram refers to clusters >10 m<sup>2</sup>. The second diagram to a cluster of four panels (1200x1040 mm) in a row with a distance of 40 mm (M502). If the clusters are arranged with distances between the clusters <0,5 meters, the Aeq per cluster will be slightly reduced.

**Sound Absorption:**

Test results according to EN ISO 354. Classification according to EN ISO 11654.

$\alpha_p$ , Practical sound absorption coefficient

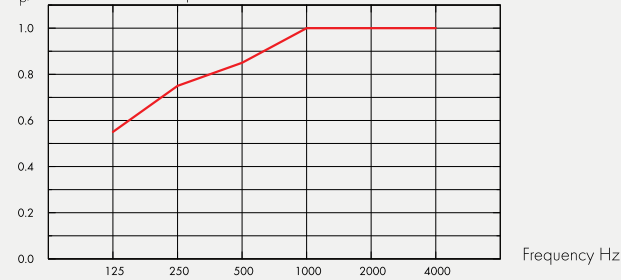

— Solo Matrix 40 mm, 300 mm o.d.s.  
o.d.s = overall depth of system

$A_{eq}$ , Equivalent absorption area per unit (m<sup>2</sup> sabin)

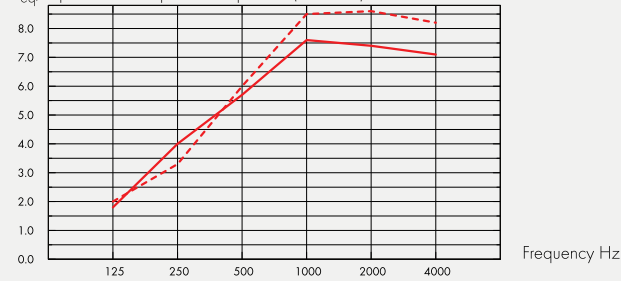

— Solo Matrix 40 mm (M502), 300 mm o.d.s.  
- - Solo Matrix 40 mm (M502), 600 mm o.d.s.  
o.d.s = overall depth of system

THK mm	o.d.s. mm	$\alpha_p$ , Practical sound absorption coefficient						$\alpha_w$	Sound absorption class
		125 Hz	250 Hz	500 Hz	1000 Hz	2000 Hz	4000 Hz		
40	300	0.55	0.75	0.85	1.00	1.00	1.00	0.95	A

THK mm	o.d.s. mm	$A_{eq}$ , Equivalent absorption area per unit (m <sup>2</sup> sabin)					
		125 Hz	250 Hz	500 Hz	1000 Hz	2000 Hz	4000 Hz
40	300	1.8	4.0	5.7	7.6	7.4	7.1
40	600	2.0	3.3	6.0	8.5	8.6	8.2
40	1000	2.1	3.5	6.4	9.1	9.2	9.0

**Indoor Air Quality:**

Certificate / Label

Eurofins Indoor Air Comfort®	IAC
French VOC	A
Finnish M1	•

**Environmental Footprint:** Life-cycle stages A1 to C4 from EPD, in conformity with ISO 14025 / EN 15804

kg CO<sub>2</sub> equiv/m<sup>2</sup>  
Solo Matrix 7,52

**Circularity:** Minimum post-consumer recycled content: 62%, Recyclability: Fully recyclable,

**Fire safety:** The glass wool core of the tiles is tested and classified as non-combustible according to EN ISO 1182. Europe: Solo panel is tested to fire standard EN 13501-1 and classed A2-s1,d0

**Humidity Resistance:** Class C, relative humidity 95% and 30°C, according to EN 13964:2014

**Visual appearance:** White Frost, nearest NCS colour sample S 0500-N, 85% light reflectance. Gloss < 1.

**Cleanability:** Daily dusting and vacuum cleaning. Weekly wet wiping.

**Accessibility:** Each panel is individually demountable from below. Panels are equipped with hatch function.

**Installation:** For design possibilities including installation direction and integrations, see installation guides, installation diagrams and drawing aid. For information regarding minimum overall depth of system see quantity specification.

**System weight:** The weight of the system (including suspension grid) should be approximately 4 kg/m<sup>2</sup>.

**Mechanical properties:** The panels can take small loads with largest aperture diameter of 100 mm. The load is restricted to maximum 250g between two Panel cross bars. For heavier loads see Installation guide.

**CE:** Ecophon ceiling systems are CE marked according to the European harmonized standard EN13964:2014. CE marked construction products are covered by a Declaration of Performance (DOP) which enables customers and users to easily compare performance of products available on the European market.

## Installation diagram in detail [www.ecophon.com](http://www.ecophon.com)

### M501

Installation diagram (M501) for Ecophon Solo Matrix in modules

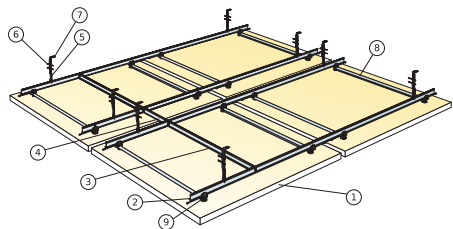

© Ecophon Group

### M502

Installation diagram (M502) for Ecophon Solo Matrix in rows

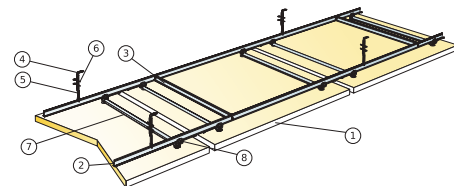

© Ecophon Group

### M503

Installation diagram (M503) for Ecophon Solo Matrix in modules

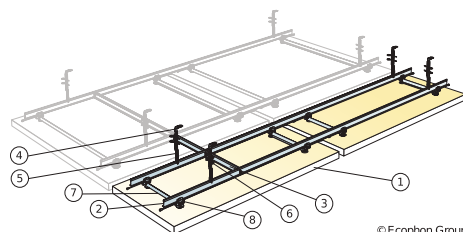

© Ecophon Group

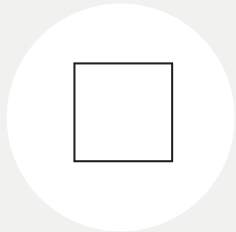

# Ecophon Solo™ Textile

**Acoustic:** The values in the diagram refer to a single unit. If the units are arranged in a cluster with distances between units less than 0,5 meters, the Aeq per unit will be slightly reduced.

**Sound Absorption:**  
Test results according to EN ISO 354.

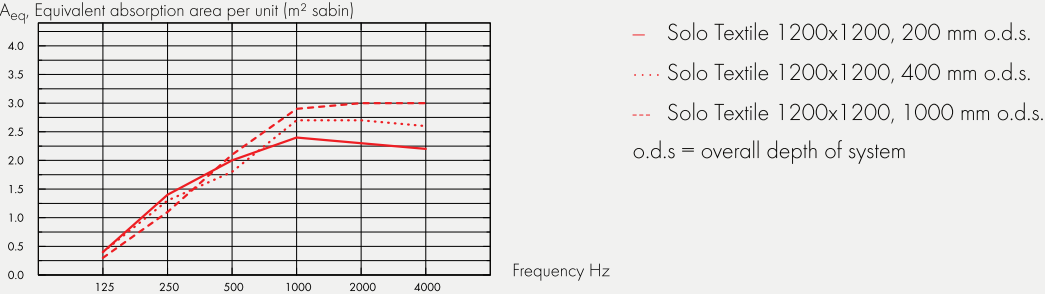

	THK mm	o.d.s. mm	A <sub>eq</sub> Equivalent absorption area per unit (m <sup>2</sup> sabin)					
			125 Hz	250 Hz	500 Hz	1000 Hz	2000 Hz	4000 Hz
1200x1200	40	200	0.4	1.4	2.0	2.4	2.3	2.2
1200x1200	40	400	0.4	1.3	1.8	2.7	2.7	2.6
1200x1200	40	1000	0.3	1.1	2.1	2.9	3.0	3.0

**Indoor Air Quality:**

Certificate / Label  
 French VOC, A •

**Circularity:** Fully recyclable.

**Fire safety:** See table Europe: EN 13501-1, B-s1,d0,

**Humidity Resistance:** Class A, relative humidity 70% and 25°C, according to EN 13964:2014

**Visual appearance:** Light reflectance and nearest NCS colour sample for all the different colours: See Ecophon Colours and surfaces. (The tiles need to be installed in accordance with the installation guide in order to get optimal visual appearance).

**Cleanability:** Weekly dusting and vacuum cleaning

**Accessibility:** The tiles are demountable.

**Installation:** Installed according to installation diagrams, installation guides and drawing aid. For information regarding minimum overall depth of system see quantity specification.

**System weight:** Approximately 7 kg.

**Mechanical properties:** No additional live load is allowed.

**CE:** Ecophon ceiling systems are CE marked according to the European harmonized standard EN13964:2014. CE marked construction products are covered by a Declaration of Performance (DOP) which enables customers and users to easily compare performance of products available on the European market.

**Installation diagram in detail [www.ecophon.com](http://www.ecophon.com)**

---

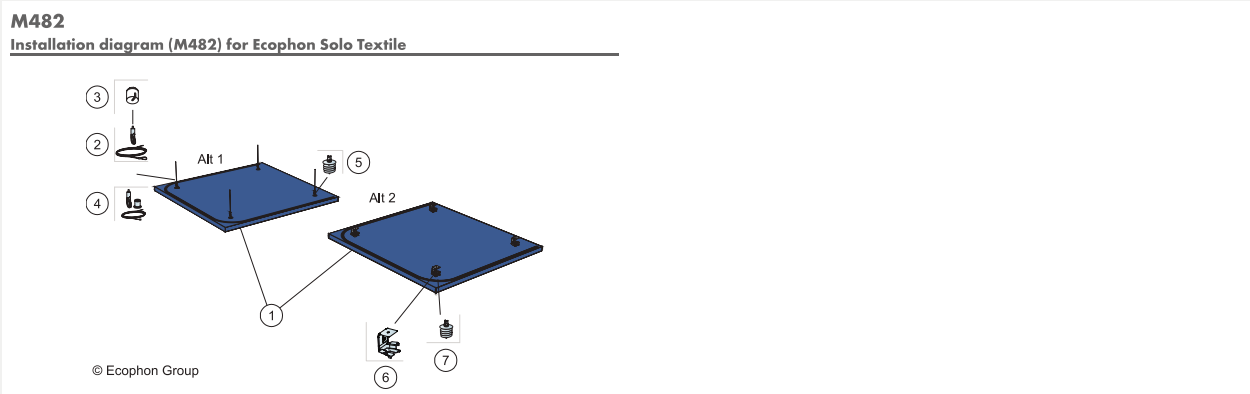



Ecophon is the leading supplier of indoor acoustic solutions that improve working performance and quality of life. We believe in the difference sound can make to our everyday lives, and are passionate advocates for the importance of room acoustics to people's wellbeing - whatever the space, activity or need.

Having a sound effect on people is the principle that guides all we do. We're proud of the Swedish heritage and human approach that promise is founded on. Our uncompromising commitment to transparent sustainable practice. And, as members of the Saint-Gobain Group, to be doing our part in making the world a better home.

Any picture, description, illustration and dimensions contained in this brochure is for information purpose only and is not contractual. This brochure shows Ecophon products and may contain third-party's products. Ecophon shall not be liable for any misprint. Ecophon reserves the right to change product specifications at any time without prior notice. Recommendations of use and installation/assembly, as well as storage, maintenance and indoor environment conditions, must always be respected. Please refer to the applicable technical documentation, such as technical data sheet and installation guidelines. For a comprehensive and up-to-date library of information, including the last version of applicable General Terms and Conditions of Sales, please visit [www.ecophon.com](http://www.ecophon.com)