

Ecophon Focus™

News and updates



Ecophon®
SAINT-GOBAIN

A SOUND EFFECT ON PEOPLE

Always fro



© Ecophon Group 2017

This publication shows products from Ecophon product range and those of other suppliers. The specifications are intended to provide a general guide to which products are most suitable for the preferences indicated. Technical data is based on results obtained under typical testing conditions or long experience in normal conditions. The specified functions and properties for products and systems are only valid on condition that instructions, installation diagrams, installation guides, maintenance instructions and other stated conditions and recommendations have been taken into consideration and followed. Deviation from this, such as changing specific components or products, will mean that Ecophon cannot be held responsible for the function, consequences and properties of the products. All descriptions, illustrations and dimensions contained in this brochure represent general information and shall not form part of any contract. Ecophon reserves the right to change products without prior notice. We disclaim any liability for misprints. For the latest information go to www.ecophon.com or contact your nearest Ecophon representative.

Idea and layout: Saint-Gobain Ecophon AB. Printer: Skånetryck AB

m Ecophon

Acoustics you can trust

- 60 years of market-leading innovation
- Superior knowledge of acoustic design
- Acoustic systems for every need

One-stop shop

- Ecophon offers complete systems, including high-quality grids, accessories and lighting
- One supplier for the whole system means one contact and one guarantee for you

Installation help

- All systems have comprehensive, easy-to-use installation guides, downloadable at ecophon.com
- New installation films are available for Ecophon Focus™ Ds, Ecophon Focus™ Ez and Ecophon Focus™ Lp. Watch them at youtube.com/ecophontv

Local technical support

- All Ecophon sales offices offer technical support in local languages
- All Ecophon sales offices offer personal assistance with your projects as well as training sessions from Ecophon

The benefits of using glass wool

- Lightweight panels
- Easy to handle
- Easy and dust-free on-site cutting
- Stable and durable panels

Ecophon Focus™ is the perfect toolbox

Ecophon Focus™ is our most comprehensive product family. This range of suspended wall-to-wall ceilings features excellent acoustics, appealing looks, easy installation and the flexibility to suit practically every need.

- 10 edges
- 11 sizes
- 16 colours
- 3 lighting solutions
- 6 unique additional solutions

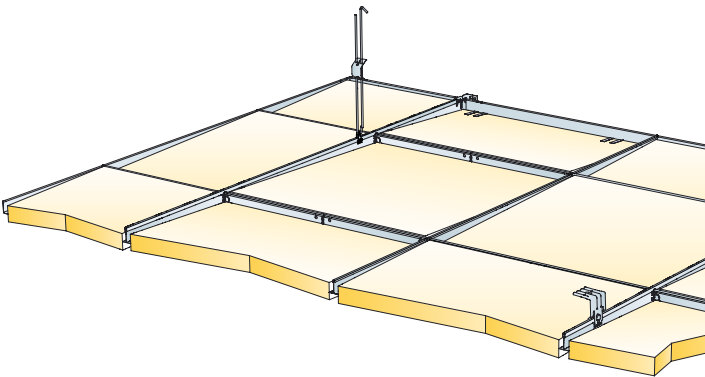

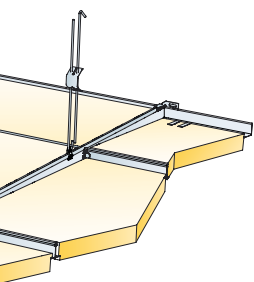

New edge – Ecophon Focus™ Ez

- Slightly tilted panel that can be placed in any orientation
- 600x600 mm panels
- Precut panels make for smooth alignment with Ecophon Dot™ LED and Ecophon Square™ LED luminaires

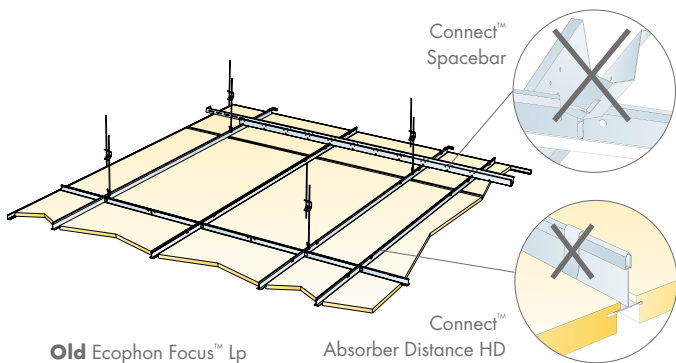

Old Ecophon Focus™ Lp

Connect™ Absorber Distance HD

Unique additional solutions

- Level changes: Ecophon Focus™ Fixiform Ds, Ecophon Focus™ Fixiform E and Ecophon Focus™ Flexiform
- Free-hanging ceilings: Ecophon Focus™ Wing and Ecophon Focus™ Edge 500
- Wall endings: Ecophon Focus™ Frieze

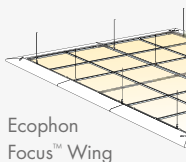

Ecophon Focus™ Wing

Ecophon Focus™ Frieze

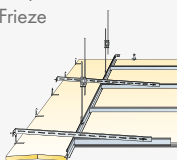



Faster installation of Ecophon Focus™ Lp

- Same range as before
- Reduced system cost and easier installation
- Connect™ Spacebar is no longer needed
- Connect™ Absorber distance HD is no longer needed
- New panels can be placed in an existing installation

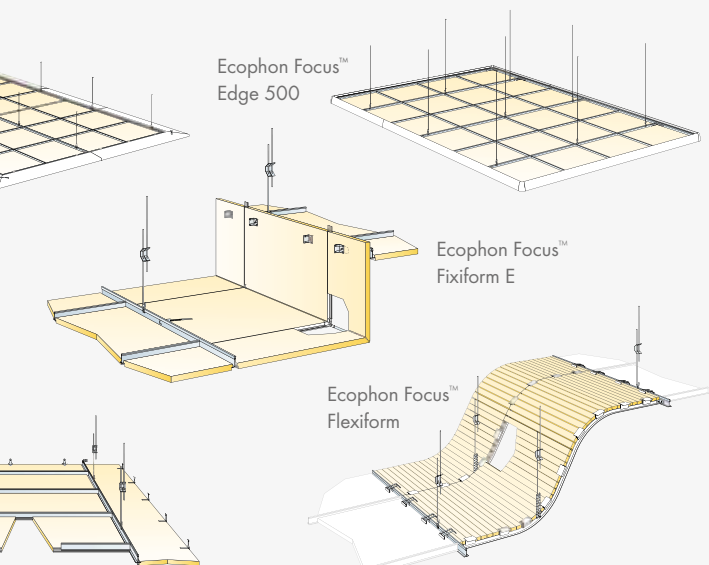
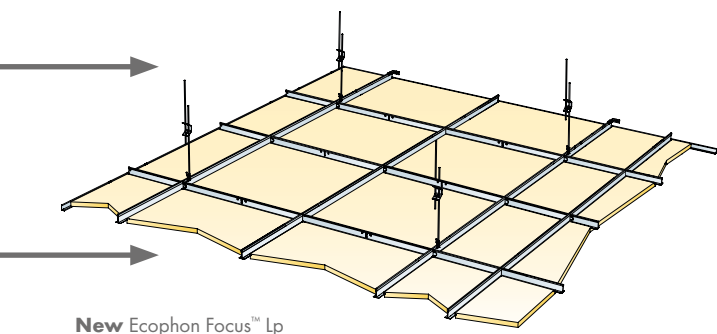

Level changes with Ecophon Focus™ Ds

- Whole standard panels
- 3 Connect™ accessories
- Faster installation

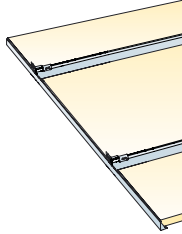

Ecophon Focus™ D/A for bandraster

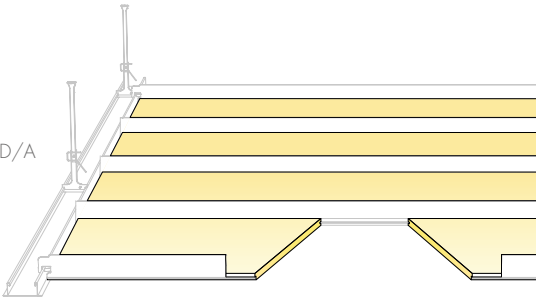

Ecophon Focus™ D/A for corridors

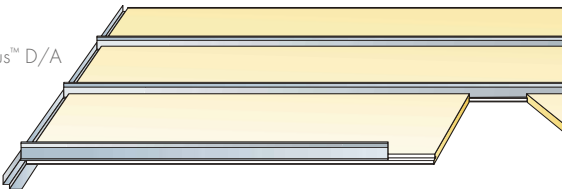

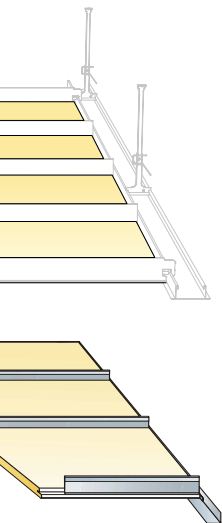
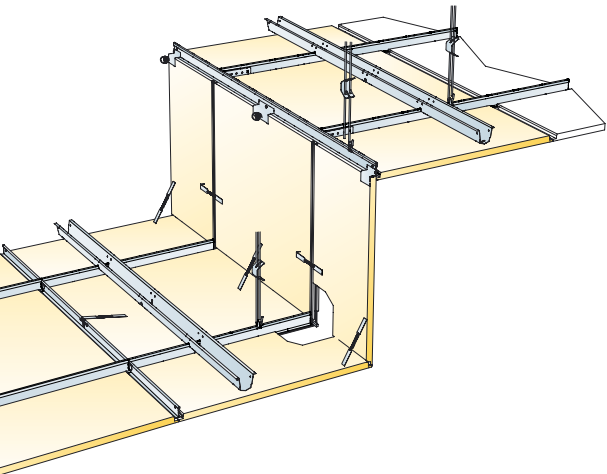

Ecophon Focus™ D/A for corridors and bandraster

- Large panels
- Edges A and D in combination
- Easy and fast installation

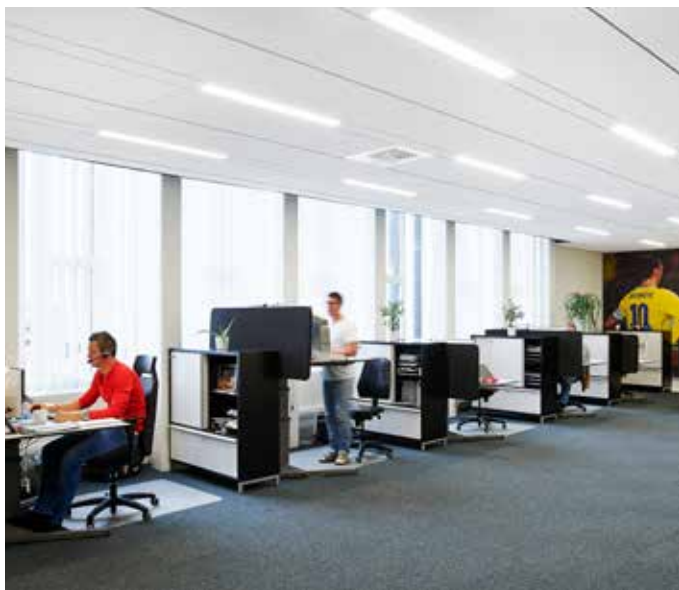

Ecophon Line™ LED

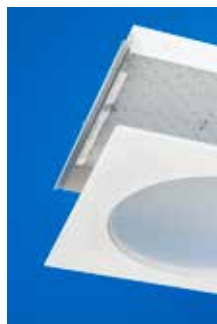

Ecophon Dot™ LED



Ecophon lighting means lighting & sound absorption in one

- Pre-cut luminaire panels
- Smooth alignment
- Sharper opal corners
- Available for Ecophon Focus™ Ds, Ecophon Focus™ Dg, Ecophon Focus™ E, Ecophon Focus™ Ez, Ecophon Focus™ Lp

Ecophon DoI™ LED
and Ecophon Square
43™ LED

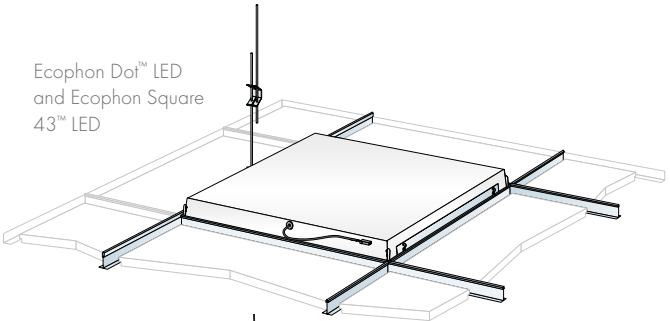

Ecophon Line™ LED

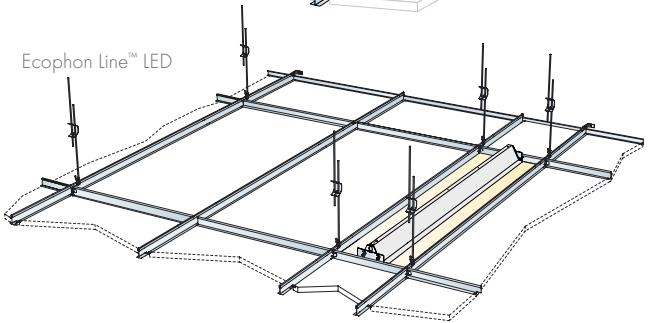

Ecophon Ecophon Square 43™ LED



New Akutex™ FT colour range

Akutex™ FT is a unique and superior surface developed by Ecophon. It has great light reflectance properties and in combination with glass wool, Akutex™ FT provides optimal acoustics. The updated range includes sixteen attractive colours.

The Akutex™ FT colours are easy to use when designing, since they have been chosen specifically to encompass all families of the NCS colour system.

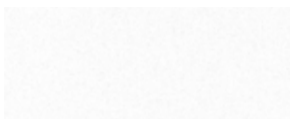

White frost

Nearest NCS colour sample S 0500-N
Light reflectance 85%.



Volcanic Ash

Nearest NCS colour sample 2002-Y
Light reflectance 56%.



Silver Stone

Nearest NCS colour sample S 4502-Y
Light reflectance 29%.

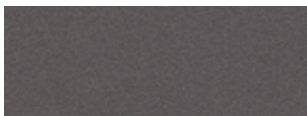

Silk Slate

Nearest NCS colour sample 7000-N
Light reflectance 13%.



Summer Breeze

Nearest NCS colour sample S 1515-B50G
Light reflectance 54%.



Golden Field

Nearest NCS colour sample S 1040-G90Y
Light reflectance 61%.



Sunset Heat

Nearest NCS colour sample S 2070-Y60R
Light reflectance 20%.



Ruby Rock

Nearest NCS colour sample S 4050-R10B
Light reflectance 7%.



Dark Diamond

Nearest NCS colour sample S 9000-N
Light reflectance 4%.



Morning Drizzle

Nearest NCS colour sample S 1002-B
Light reflectance 69%.



Silent Steam

Nearest NCS colour sample S 2010-B
Light reflectance 45%.



Ocean Storm

Nearest NCS colour sample S 4020-R90B
Light reflectance 24%.



Moonlight Sky

Nearest NCS colour sample S 7020-R90B
Light reflectance 7%.



Cloudy Day

Nearest NCS colour sample S 1500-N
Light reflectance 62%.



Pale Pearl

Nearest NCS colour sample S 2005-R30B
Light reflectance 55%.



Highland Fog

Nearest NCS colour sample S 2005-G
Light reflectance 55%.

Connect™ grid and Ecophon Focus™ Edge 500 Colours



Connect white 01

Nearest NCS colour sample: S 0500-N
Gloss 20

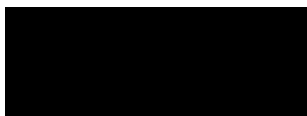

Connect black 01 matt

Nearest NCS colour sample S 9000-N
Gloss 3



Connect grey 01 metallic

Nearest NCS colour sample: S 2502-B
Natural variation in gloss and colour can occur.

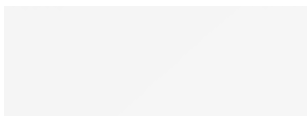















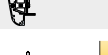

Focus Edge 500

Connect white 02 textured

Nearest NCS colour sample: S 0500-N
Gloss 2

Ecophon Focus™ overview

Edge design	Product	Connect grid	Sizes 150-1200 mm
	Ecophon Focus™ A	T15 / T24	600x600x20, 1200x600x20, 1200x1200x20
	Ecophon Focus™ B	Direct fixing	600x600x20
	Ecophon Focus™ Ds	T24	600x600x20, 1200x600x20, 1200x1200x20
	Ecophon Focus™ Dg	T24	600x600x20, 1200x600x20, 1200x1200x25
	Ecophon Focus™ D/A	T24 Bandrastrer	
	Ecophon Focus™ E	T15 / T24	600x600x20, 1200x600x20, 1200x1200x20
	Ecophon Focus™ Ez	T24	600x600x40
	Ecophon Focus™ F	Direct fixing	600x600x20, 1200x600x20
	Ecophon Focus™ Lp	T24	600x150x20, 600x300x20, 600x600x20, 1200x150x20, 1200x300x20, 1200x600x20
	Ecophon Focus™ SQ	Direct fixing	600x600x20, 1200x600x20
	Ecophon Focus™ Edge 500	T24	
	Ecophon Focus™ Fixiform Ds	T24	1200x600x20
	Ecophon Focus™ Fixiform E	T24	1200x600x20
	Ecophon Focus™ Flexiform A	T24	1200x600x30
	Ecophon Focus™ Frieze	T24	
	Ecophon Focus™ Wing	T24	1200x200x50



All Ecophon Focus™ products with 3rd generation glass wool comply with the California Emission Regulation standard and French VOC A+, the two toughest standards in the world for formaldehyde and VOC emissions.

All Ecophon Focus™ products can be dry-wiped daily, vacuumed daily and wet-wiped weekly.

XL	Ecophon Lighting	Possible combinations	Absorption class
1600x600x20, 1800x600x20, 2000x600x20, 2400x600x20		Focus Flexiform A, Focus Frieze	A
			C
1600x600x20, 1800x600x20, 2000x600x20, 2400x600x20	Ecophon Dot™ LED, Ecophon Line™ LED, Ecophon Square 43™ LED	Focus Ds Level change, Focus Edge 500, Focus Fixiform Ds, Focus Frieze, Focus Wing	A
1600x600x20, 1800x600x20, 2000x600x20, 2400x600x20	Ecophon Dot™ LED, Ecophon Line™ LED, Ecophon Square 43™ LED	Focus Edge 500, Focus Frieze	A
1720x300x20, 1720x600x20, 2000x600x20, 2400x600x20			A
1600x600x20, 1800x600x20, 2000x600x20, 2400x600x20	Ecophon Dot™ LED, Ecophon Line™ LED, Ecophon Square 43™ LED	Focus Edge 500, Focus Fixiform E, Focus Frieze, Focus Wing	A
	Ecophon Dot™ LED, Ecophon Square 43™ LED		A
			C
1800x600x20	Ecophon Line™ LED		A
			C
2400x30x80		Focus Ds, Focus Dg, Focus E	
1500x600x20, 1900x600x20, 2300x600x20		Focus Ds	A
		Focus E	A
1600x600x30, 2000x600x30, 2400x600x30		Focus A	A
2400x600x20		Focus A, Focus Ds, Focus Dg, Focus E	A
		Focus Ds, Focus E	A



Ecophon®

SAINT-GOBAIN

A SOUND EFFECT ON PEOPLE

Ecophon is the leading supplier of acoustic solutions. We contribute to healthier indoor environments, improving quality of life, wellbeing and working performance. As evolution has adapted the human senses to a life outdoors, our focus is to bring the ideal acoustic environments of nature into our modern indoor spaces. We know they will have a sound effect on people.



The principles guiding our work are grounded in our Swedish heritage, where a human approach and a common responsibility for people's lives and future challenges come naturally.

Ecophon is part of the Saint-Gobain Group, a world leader in sustainable habitat solutions. This is also one of the top 100 industrial groups in the world, constantly innovating to make living spaces more comfortable and cost-efficient. Saint-Gobain offer solutions to the major challenges of energy efficiency and environmental protection. No matter what new needs emerge in the habitat and construction markets, the future is made of Saint-Gobain.



www.ecophon.com