

A UNIVERSE
OF DESIGN
FLEXIBILITY

ECOPHON FOCUS™



Ecophon
SAINT-GOBAIN

Contents

04 ABOUT ECOPHON

06 GOOD ACOUSTICS MATTER EVERYWHERE

08 BUILDING ON BETTER

10 A UNIVERSE OF DESIGN FLEXIBILITY WITH ECOPHON FOCUS™

12 ECOPHON FOCUS PRODUCT RANGE

- 16 Focus A
- 16 Focus B
- 17 Focus Ds
- 17 Focus Dg
- 18 Focus D/A
- 18 Focus E
- 19 Focus Ez
- 19 Focus F
- 20 Focus Lp
- 20 Focus SQ
- 21 Focus Levels
- 21 Focus Flexiform A
- 22 Focus Edge 500
- 23 Focus Fixiform E
- 23 Focus Fixiform Ds
- 24 Focus Frieze
- 24 Focus Wing
- 25 Square 43
- 26 Dot
- 27 Line

28 COLOURS AND SURFACES

30 ECOPHON FOCUS OVERVIEW

32 SYSTEM PROPERTIES

Acoustics, technical properties and installation diagrams

This publication shows products from Ecophon product range and those of other suppliers. The specifications are intended to provide a general guide to which products are most suitable for the preferences indicated. Technical data is based on results obtained under typical testing conditions or long experience in normal conditions. The specified functions and properties for products and systems are only valid on condition that instructions, installation diagrams, installation guides, maintenance instructions and other stated conditions and recommendations have been taken into consideration and followed. Deviation from this, such as changing specific components or products, will mean that Ecophon cannot be held responsible for the function, consequences and properties of the products. All descriptions, illustrations and dimensions contained in this brochure represent general information and shall not form part of any contract. Ecophon reserves the right to change products without prior notice. We disclaim any liability for misprints. For the latest information go to www.ecophon.com or contact your nearest Ecophon representative.



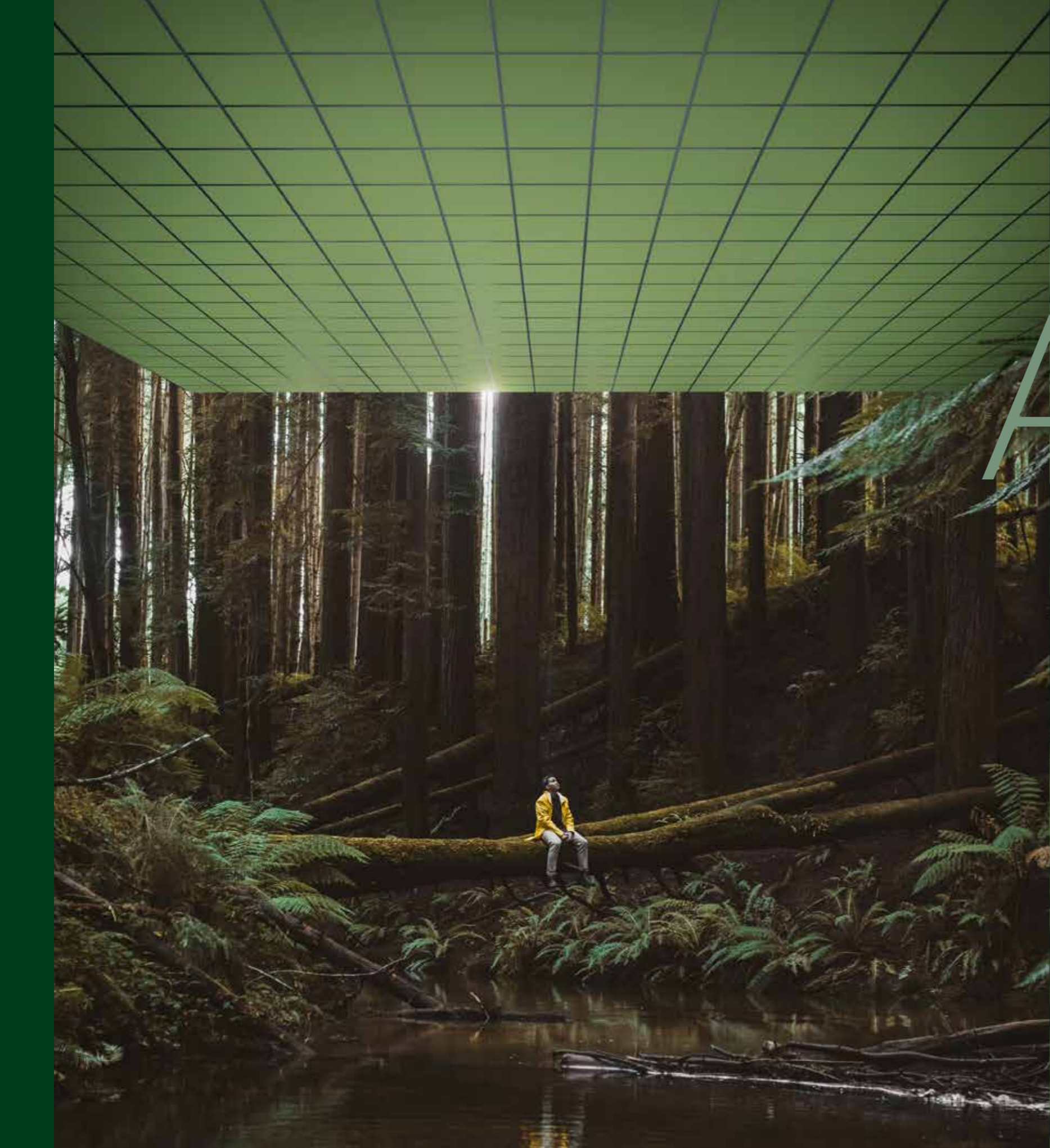

A sound effect

ON PEOPLE

Saint-Gobain Ecophon contributes to good indoor environments for working, healing and learning. We do this by developing, manufacturing and delivering acoustic products and systems designed around the natural evolution of human hearing – replicating the outdoor sound experience indoors, because that's just better for people.

Having a sound effect on people, in every way we can, is what we do proudly. That promise makes every one of us a passionate advocate for the importance of room acoustics to people's wellbeing – whatever the space, activity or need.

Good acoustics

MATTER EVERYWHERE

The importance of acoustics is underappreciated. Sound impacts us in daily life, and the scientific support for improving our indoor sound environments is well-documented.

And what exactly is an ideal indoor sound environment for people? One based on how we experience sound outside. The human auditory sense is naturally adapted to an outdoor environment where there is not any sound reflections from ceilings and walls.

That's why most of what we do at Ecophon is about replicating the acoustic qualities found in nature for indoor environments. We want to optimise indoor spaces to our natural way of hearing, so that speech and sound is easy to hear and understand, when needed, improving performance and wellbeing.

Usually that starts with the ceiling. A wall-to-wall acoustic ceiling is the easiest way to get a large sound-absorbing surface area into a space, and is usually the best way to reduce sound strength, shorten reverberation times, and increase speech clarity and overall hearing comfort.

But for a truly optimal sound environment, you'll also likely need different kinds of sound absorbers placed strategically throughout the space—wall-mounted panels and free-standing dividers are just two examples. In other words, a holistic approach is the best way to reduce the overall sound level and sound propagation in a room. Ecophon is here to help.





Building on

BETTER

Sustainability is more than a word – it's a collective movement to protect people and the planet that requires honest commitment and genuine care. That's why Ecophon is building on better materials, transparency, and principles, to name just a few.

We actively support an industry-wide drive to standardized, easy-access Environmental Product Declarations for individual products, rather than product families. Their inclusion of full lifecycle data, from raw material sourcing to end of life, rather than only the favorable stages. A move away from self-declared labels, or non-independently verified sustainability claims. And for any promises of net zero carbon emission targets to be validated by the Science-Based Targets initiative.

If we're going to build a sustainable future, it has to start with an honest approach, high ambition and the best of intentions – to build on better together.



ecophon FOCUS™

A UNIVERSE OF DESIGN FLEXIBILITY

Ecophon Focus™ is our most comprehensive system family and supports a range of opportunities through different edge designs, forms, levels and installation options.

- Absorption class A
- 10 different edge options in addition to 6 unique solutions
- Premium surface with superior quality and a matte look

Focus is a great choice for cellular offices, corridors, receptions, entrance halls, waiting rooms, team work spaces and other public areas where visual appeal and sound quality are equally important.

The Focus family includes panels that can be fixed directly to soffit. That gives you options for spaces that might seem challenging or impossible to improve acoustically, such as stairwells, basements and spaces with low ceiling height.

Minimum
51%
post-consumer recycled
content



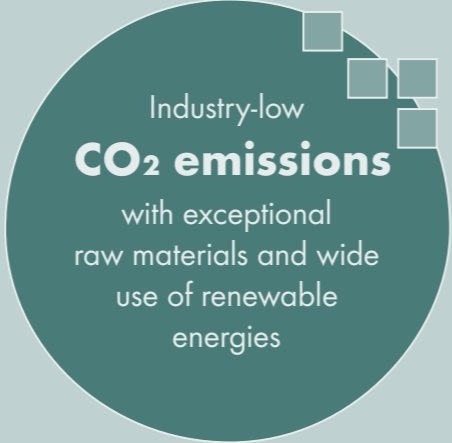

ECOPHON FOCUS™ PRODUCT RANGE

Focus is suspended wall-to-wall ceilings with excellent acoustic properties, appealing looks and the flexibility to suit every need make the Focus family the perfect toolbox.

The Focus family includes six unique complementary solutions for level changes, wall endings and free-hanging ceilings. They are designed to give the

ceiling an integrated appearance that enhances the overall aesthetic appeal.

Focus Levels gives you still more design options. With Levels, you combine a variety of panel thicknesses and sizes to give a ceiling or wall its own uniquely staggered look and feel.

FOCUS A

- 600x600x20
- 1200x600x20
- 1200x1200x20
- 1600x600x20
- 1800x600x20
- 2000x600x20
- 2400x600x20



FOCUS B

- 600x600x20
- 1200x600x20



FOCUS Ds

- 600x600x20
- 1200x600x20
- 1200x1200x20
- 1600x600x20
- 1800x600x20
- 2000x600x20
- 2400x600x20



FOCUS Dg

- 600x600x20
- 1200x600x20
- 1200x1200x25
- 1600x600x20
- 1800x600x20
- 2000x600x20
- 2400x600x20



FOCUS D/A

- 1720x600x20
- 2000x600x20
- 2400x600x20



FOCUS Ez

- 600x600x40
- Patented system



FOCUS Lp

- 600x150x20
- 600x300x20
- 600x600x20
- 1200x150x20
- 1200x300x20
- 1200x600x20
- 1800x600x20



Patented system

FOCUS LEVELS

- 600x600x20
- 1200x600x20
- 1200x300x20
- 600x600x30
- 1200x600x30
- 1200x300x30
- 600x600x40
- 1200x300x40



FOCUS E

- 600x600x20
- 1200x600x20
- 1200x1200x20
- 1600x600x20
- 1800x600x20
- 2000x600x20
- 2400x600x20



FOCUS F

- 600x600x20
- 1200x600x20



FOCUS SQ

- 600x600x20
- 1200x600x20



FOCUS FLEXIFORM A

- 1200x600x30
- 1600x600x30
- 2000x600x30
- 2400x600x30



FOCUS FIXIFORM E

1200x600x20



FOCUS FIXIFORM Ds

1200x600x20
1500x600x20
1900x600x20
2300x600x20



FOCUS FRIEZE

2400x600x20



FOCUS EDGE 500

600x600x20
1200x600x20
1200x1200x20
1200x1200x25



FOCUS WING

600x200x50
1200x200x50



SQUARE 43

Edge Ds, Dg, E:
600x600x20



Edge Ez:
600x600x40

DOT

Edge Ds, Dg, E:
600x600x20



Edge Ez:
600x600x40

LINE

Edge Lp:
1200x150x20
1200x300x20



Edge Ds, Dg, E:
1200x600x20





FOCUS A

Visible grid system and easy demountable tiles. Available in many formats.

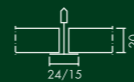

FOCUS Ds

Bevelled edges that generates a discreet groove between the tiles. Concealed grid system.

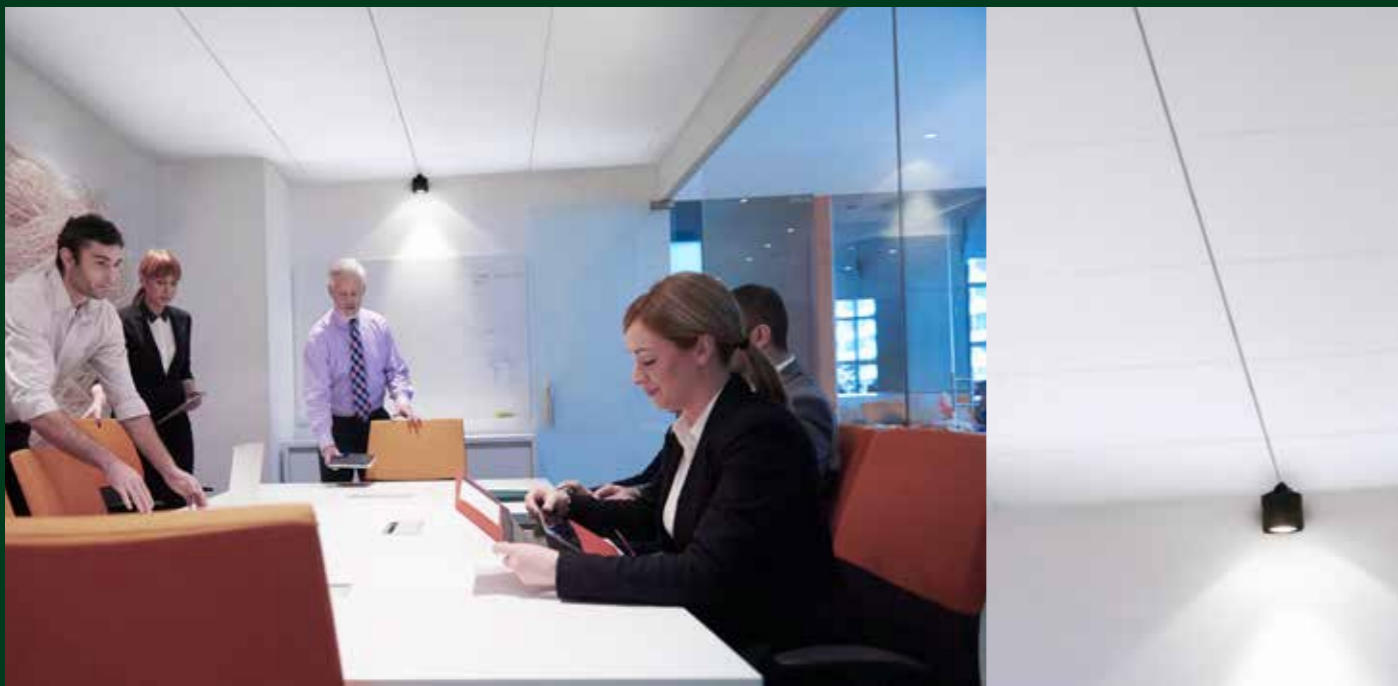
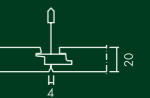

FOCUS B

For direct fixing with glue, ideal for installations that require minimum depth of system.



FOCUS Dg

Unique edge design with concealed support edges and a floating appearance.

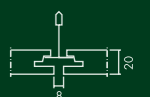



FOCUS D/A

For corridors and bandraster solutions. Long panels with a concealed grid system.

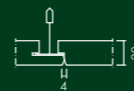

FOCUS Ez

A patented system with support edges in different levels enabling a tilted appearance and unique designs.

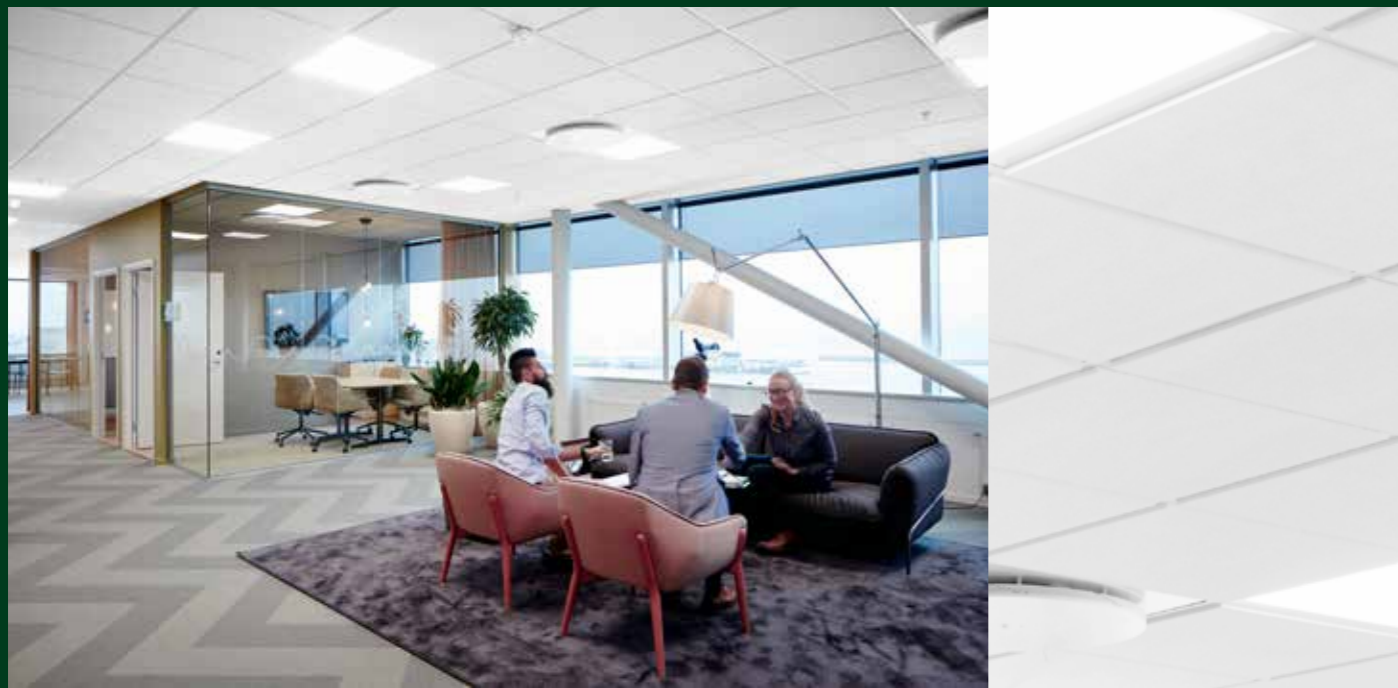
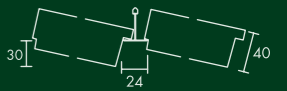

FOCUS E

Recessed visible grid system creating a shadow effect on the edge. Easily demountable tiles.

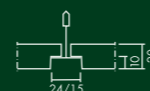

FOCUS F

For direct fixing with screws, ideal for installations that require minimum depth of system.

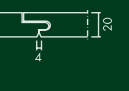



FOCUS Lp

A patented system designed to create long rows in the ceiling, highlighting a specific direction in the room.

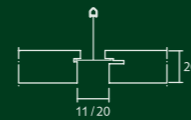

FOCUS LEVELS

Different panel thicknesses within the system for creating unique patterns on walls and ceilings.

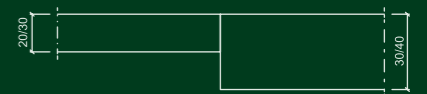

FOCUS SQ

For direct fixing with glue. Installed with a gap between each tile.

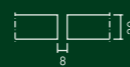

FOCUS FLEXIFORM A

Flexible panels that can be shaped into concave or convex forms.

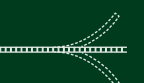



FOCUS EDGE 500
Edge profile for island installations. Profile in extruded aluminium and corners in cast zinc.



FOCUS FIXIFORM E
Foldable tiles for smooth transitions where there are level shiftings in the ceiling.

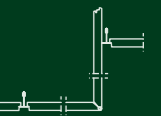

FOCUS FIXIFORM Ds
Foldable tiles for smooth transitions where there are level shiftings in the ceiling.

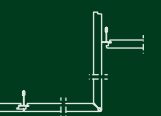



FOCUS FRIEZE

End panels for creating a smooth transition between the ceiling and the wall.

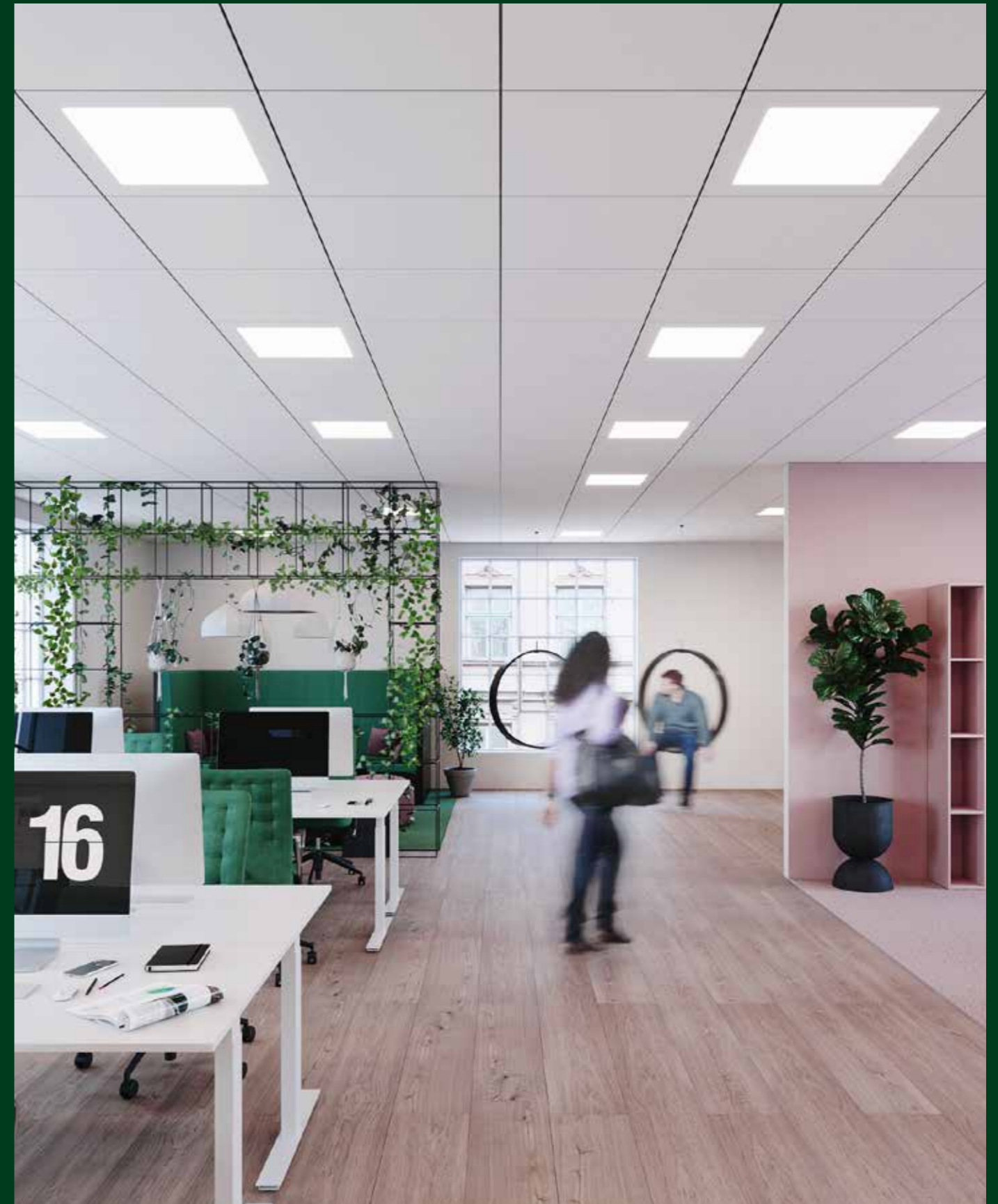
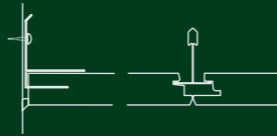

SQUARE 43

Great lighting comfort and low UGR value.

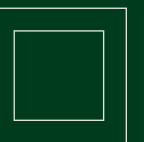

FOCUS WING

Wing shaped absorbers for free hanging suspended ceilings.

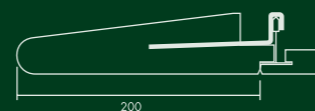



DOT
Great lighting comfort and low UGR value.

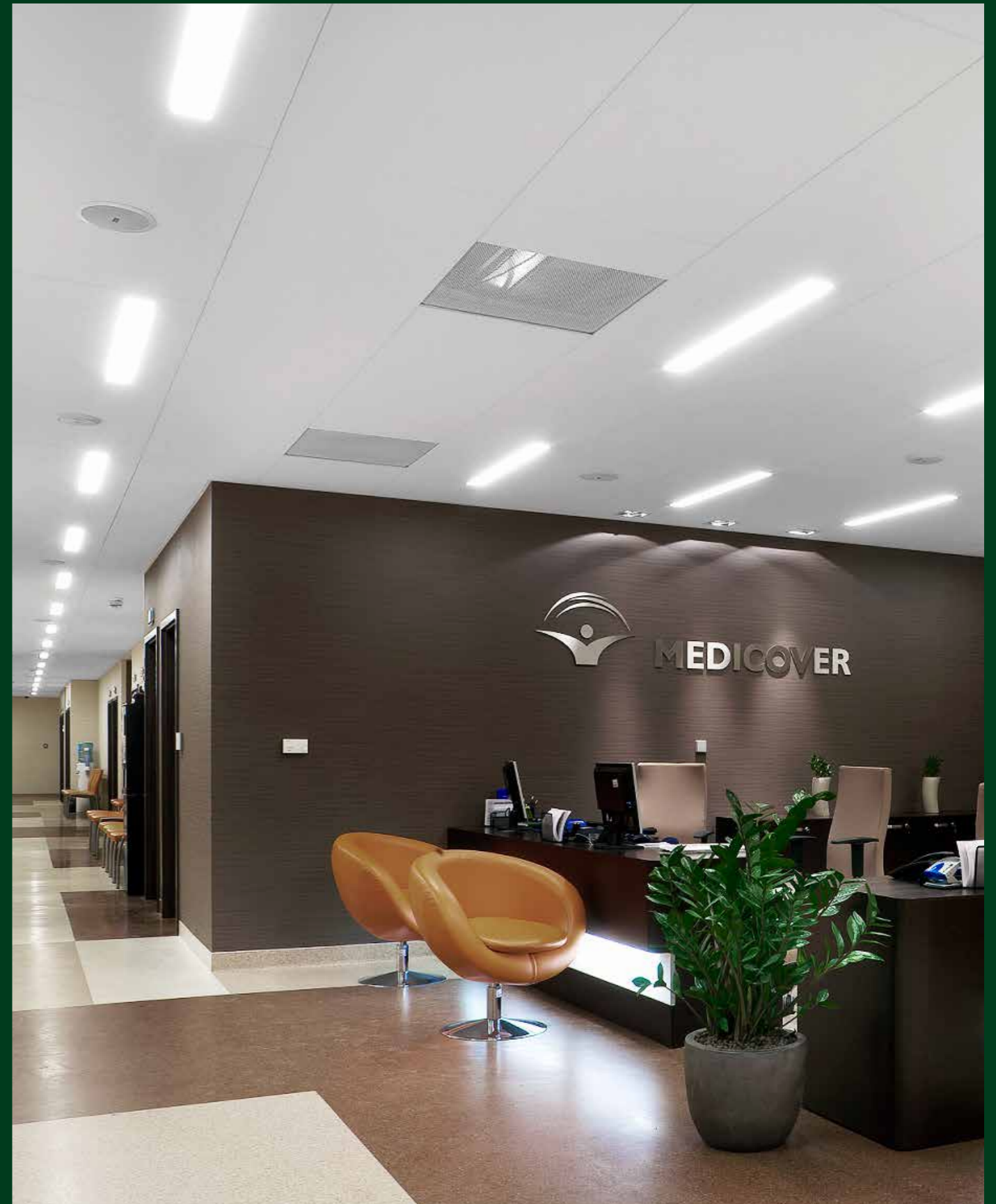
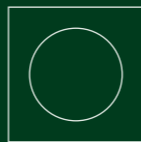

LINE
The luminaire has great lighting comfort and adds a distinct direction to the ceiling.

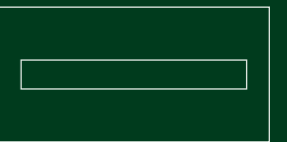

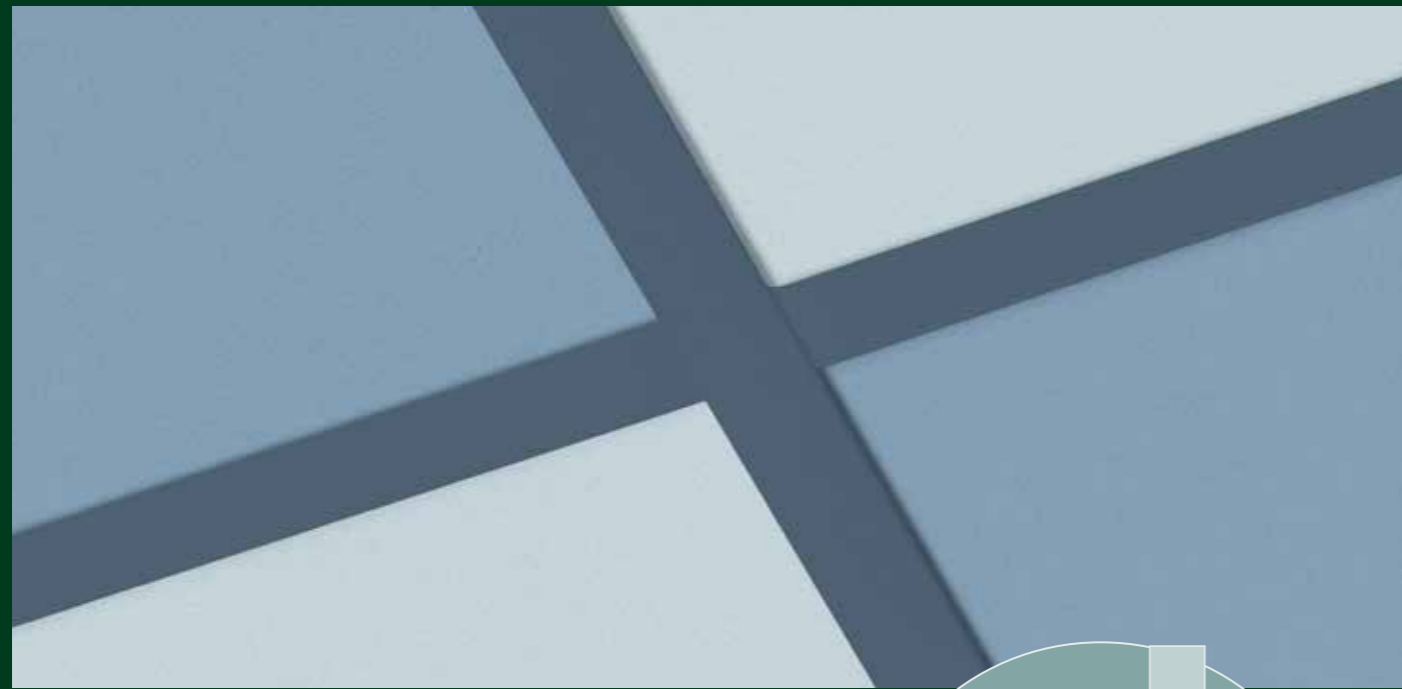

GRID COLOURS

- 15 colour options for grids
- Create your own design
- Closest Akutex FT match creates subtile pattern and mixing FT colours gives more design effect

An acoustic ceiling is often the largest continuous surface in a room. It will affect not only the entire look and feel of the interior, but also the end-users' wellbeing.



COLOURS AND SURFACES

AKUTEX™ FT

The Akutex label guarantees that the product carrying it has a superior surface technology. Our research and development will always focus on visual aspects, acoustic properties, working environment, architectural trends and environmental aspects. This ensures that Akutex is always one step ahead.

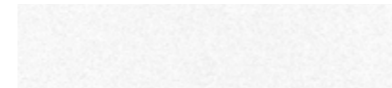

WHITE FROST | Light reflectance 85%.
Nearest NCS colour sample S 0500-N.
Grid colour NCS S 1000-N.



OCEAN STORM | Light reflectance 24%.
Nearest NCS colour sample S 4020-R90B.
Grid colour NCS S 4010-R90B.



MORNING DRIZZLE | Light reflectance 69%.
Nearest NCS colour sample S 1002-B.



VOLCANIC ASH | Light reflectance 56%.
Nearest NCS colour sample 2002-Y.



MOONLIGHT SKY | Light reflectance 7%.
Nearest NCS colour sample S 7020-R90B.
Grid colour NCS S 7010-R90B.



CLOUDY DAY | Light reflectance 62%.
Nearest NCS colour sample S 1500-N.



SILVER STONE | Light reflectance 29%.
Nearest NCS colour sample S 4502-Y.



GOLDEN FIELD | Light reflectance 61%.
Nearest NCS colour sample S 1040-G90Y.



PEACH ROSE | Light reflectance 55%.
Nearest NCS colour sample S 1515-Y80R.
Grid colour NCS S 1510-Y80R.



SILK SLATE | Light reflectance 13%.
Nearest NCS colour sample S 7000-N.
Grid colour NCS S 6500-N.



SUNSET HEAT | Light reflectance 20%.
Nearest NCS colour sample S 2070-Y60R.



HIGHLAND FOG | Light reflectance 55%.
Nearest NCS colour sample S 2005-G.
Grid colour NCS S 2005-G20Y.



GOJI BERRY | Light reflectance 27%.
Nearest NCS colour sample S 3030-Y80R.
Grid colour NCS S 3030-Y80R.



RUBY ROCK | Light reflectance 7%.
Nearest NCS colour sample S 4050-R10B.



SAGE GARDEN | Light reflectance 40%.
Nearest NCS colour sample S 3010-B30G.
Grid colour NCS S 3010-B30G.



SILENT STEAM | Light reflectance 45%.
Nearest NCS colour sample S 2010-B.
Grid colour NCS S 2005-R90B.



EUCALYPTUS LEAF | Light reflectance 23%.
Nearest NCS colour sample S 5010-B30G.
Grid colour NCS S 5010-B30G.



FRESH CLOVER | Light reflectance 35%.
Nearest NCS colour sample S 3020-G40Y.
Grid colour NCS S 3020-G40Y.



SCALLOP SHELLS | Light reflectance 76%.
Nearest NCS colour sample S 0804-Y50R.
Grid colour NCS S 0603-Y60R.



SUMMER FOREST | Light reflectance 10%.
Nearest NCS colour sample S 6030-G10Y.
Grid colour NCS S 6030-G10Y.



WET SAND | Light reflectance 35%.
Nearest NCS colour sample S 3020-Y30R.
Grid colour NCS S 3020-Y40R.



DARK DIAMOND | Light reflectance 4%.
Nearest NCS colour sample S 9000-N.
Grid colour NCS S 8000-N.

NOTE

Colours may vary slightly between different production batches.

Reproduction of colours vary between print and reality.

ECOPHON FOCUS OVERVIEW

Edge design	Product	Absorption class	Connect grid	Sizes (mm)	Ecophon Lighting	Possible combinations
	Ecophon Focus A	A	T15 / T24	600x600x20, 1200x600x20, 1200x1200x20, 1600x600x20, 1800x600x20, 2000x600x20, 2400x600x20		Ecophon Focus Flexiform A Ecophon Focus Frieze
	Ecophon Focus B	C	Direct fixing	600x600x20 1200x600x20		
	Ecophon Focus Ds	A	T24	600x600x20, 1200x600x20, 1200x1200x20, 1600x600x20, 1800x600x20, 2000x600x20, 2400x600x20	Ecophon Dot Ecophon Square 43 Ecophon Line	Ecophon Focus Edge 500 Ecophon Focus Fixiform Ds Ecophon Focus Frieze Ecophon Focus Wing
	Ecophon Focus Dg	A	T24	600x600x20, 1200x600x20, 1200x1200x25, 1600x600x20, 1800x600x20, 2000x600x20, 2400x600x20	Ecophon Dot Ecophon Square 43 Ecophon Line	Ecophon Focus Edge 500 Ecophon Focus Frieze
	Ecophon Focus D/A	A	T24 Bandraaster	1720x600x20, 2000x600x20, 2400x600x20		
	Ecophon Focus E	A	T15 / T24	600x600x20, 1200x600x20, 1200x1200x20, 1600x600x20, 1800x600x20, 2000x600x20, 2400x600x20	Ecophon Dot Ecophon Square 43 Ecophon Line	Ecophon Focus Edge 500 Ecophon Focus Fixiform E Ecophon Focus Frieze Ecophon Focus Wing
	Ecophon Focus Ez	A	T24	600x600x40	Ecophon Dot Ecophon Square 43	
	Ecophon Focus F	C	Direct fixing	600x600x20, 1200x600x20		
	Ecophon Focus Lp	A	T24	600x150x20, 600x300x20, 600x600x20 1200x150x20, 1200x300x20, 1200x600x20 1800x600x20	Ecophon Line	
	Ecophon Focus SQ	C	Direct fixing	600x600x20, 1200x600x20		
	Ecophon Focus Levels	Up to A	Direct fixing, ceiling and wall	600x600x20, 1200x600x20, 1200x300x20, 600x600x30, 1200x600x30, 1200x300x30, 600x600x40, 1200x600x40, 1200x300x40		
	Ecophon Focus Flexiform A	A	T24	1200x600x30, 1600x600x30, 2000x600x30, 2400x600x30		Ecophon Focus A
	Ecophon Focus Fixiform E	A	T24	1200x600x20		Ecophon Focus E
	Ecophon Focus Fixiform Ds	A	T24	1200x600x20, 1500x600x20, 1900x600x20, 2300x600x20		Ecophon Focus Ds
	Ecophon Focus Frieze	A	T24	2400x600x20		Ecophon Focus A Ecophon Focus Ds Ecophon Focus Dg Ecophon Focus E
	Ecophon Focus Edge 500		T24	600x600x20, 1200x600x20, 1200x1200x20 1200x1200x25		Ecophon Focus Ds Ecophon Focus Dg Ecophon Focus E
	Ecophon Focus Wing	A	T24	600x200x50, 1200x200x50		Ecophon Focus Ds Ecophon Focus E



Ecophon Focus panels contribute to a healthy indoor environment with superior acoustic absorption, low VOC emissions in line with the strictest requirements, and a full chemical transparency with verified Health Product Declarations. The low environmental footprint of our Focus panels is third-party verified in Environmental Product Declarations.

The products do not contribute to fire and the glass wool core of the Focus tiles is tested and classified as non-combustible according to EN ISO 1182. Fire classification according to EN 13501-1, see Technical Properties on respectively product.

NOTE

More product and system information such as installation help and sustainability documentation can be found at www.ecophon.com



System properties

ACOUSTICS, TECHNICAL PROPERTIES AND INSTALLATION DIAGRAMS

- 34 Focus A
- 37 Focus B
- 39 Focus Ds
- 42 Focus Dg
- 44 Focus D/A
- 46 Focus E
- 50 Focus Ez
- 52 Focus F
- 54 Focus Lp
- 56 Focus SQ
- 58 Focus Levels
- 60 Focus Flexiform A
- 62 Focus Edge 500
- 64 Focus Fixiform E
- 66 Focus Fixiform Ds
- 68 Focus Frieze
- 69 Focus Wing
- 71 Square 43
- 72 Dot
- 73 Line



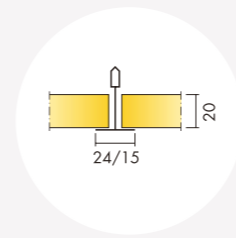

Ecophon Focus™ A

Acoustics:

Sound Absorption:

Test results according to EN ISO 354. Classification according to EN ISO 11654, and the single value ratings for Noise Reduction Coefficient, NRC and Sound Absorption Average, SAA according to ASTM C 423.

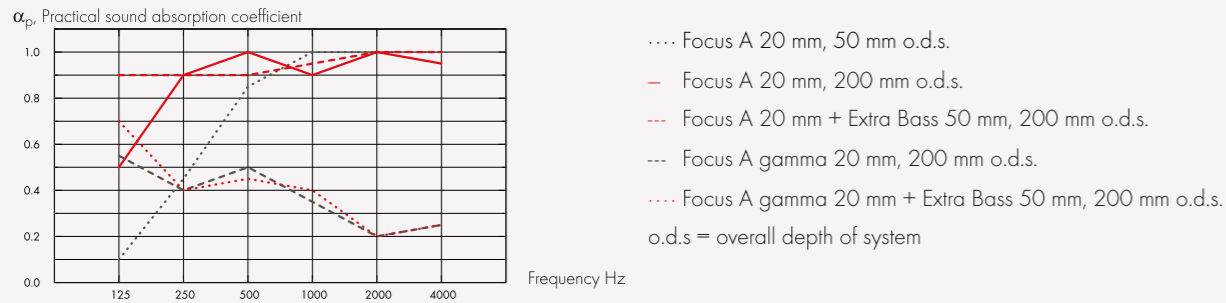

	THK mm	o.d.s. mm	α_p Practical sound absorption coefficient						α_w	Sound absorption class
			125 Hz	250 Hz	500 Hz	1000 Hz	2000 Hz	4000 Hz		
-	20	50	0.10	0.45	0.85	1.00	1.00	1.00	0.75	C
-	20	200	0.50	0.90	1.00	0.90	1.00	0.95	1.00	A
+ Extra Bass,	70	200	0.90	0.90	0.90	0.95	1.00	1.00	0.95	A
gamma	20	200	0.55	0.40	0.50	0.35	0.20	0.25	0.30	D
gamma+ Extra Bass	70	200	0.70	0.40	0.45	0.40	0.20	0.25	0.30	D

	THK mm	o.d.s. mm	NRC	SAA
-	20	50	0.85	0.83
-	20	200	0.95	0.93
+ Extra Bass,	70	200	0.93	0.93
gamma	20	200	0.35	0.36
gamma+ Extra Bass	70	200	0.35	0.37
-	20	400	0.85	0.88

THK mm	AC(1.5) Articulation Class, ASTM E1111, ASTM E1110	D_{nfw} Weighted normalized flanking level difference, ISO 10848-2	CAC dB Ceiling Attenuation Class, ASTM 1414, ASTM E413
20	190	20	21

Indoor Air Quality:

Certificate / Label	Standard	Plant
Eurofins Indoor Air Comfort®	IAC	IAC Gold
French VOC	A	A+
Finnish M1	•	•

Environmental Footprint: Life-cycle stages A1 to C4 from EPD, in conformity with ISO 14025 / EN 15819 Focus A: 2,6 , Focus A/Plant: 1,81 ,

Circularity: Minimum post-consumer recycled content: 51%, Recyclability: Fully recyclable,

Fire safety: The glass wool core of the tiles is tested and classified as non-combustible according to EN ISO 1182. Europe: EN 13501-1, A2-s1,d0,

Humidity Resistance: According to EN 13964:2014 Standard: Class C, RH 95% and 30°C, Plant: Class A, RH 70% and 25°C,

Visual appearance: White Frost, nearest NCS colour sample S 0500-N, 85% light reflectance. Gloss < 1.

Cleanability: Daily dusting and vacuum cleaning. Weekly wet wiping.

Accessibility: The tiles are easily demountable. Minimum demounting depth according to installation diagrams.

Installation: Installed according to installation diagrams, installation guides and drawing aid. For information regarding minimum overall depth of system see quantity specification.

System weight: The weight of the system (including suspension grid) should be approximately 3 kg/m².

Mechanical properties: See table about Max live load and Min load bearing capacity and Functional demands, Mechanical properties at www.ecophon.com.

CE: Ecophon ceiling systems are CE marked according to the European harmonized standard EN 13964:2014. CE marked construction products are covered by a Declaration of Performance (DOP) which enables customers and users to easily compare performance of products available on the European market.

Installation diagram in detail www.ecophon.com

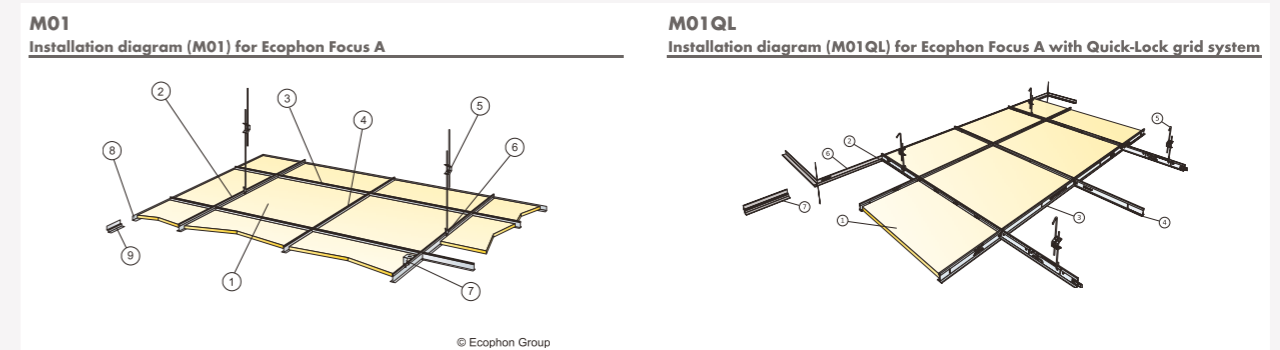

M01 DIN
Installation diagram (M01 DIN) for Ecophon Focus A

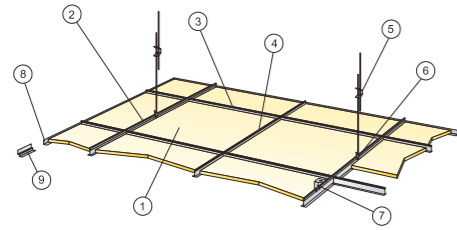

© Ecophon Group

M16
Installation diagram (M16) for Ecophon Focus A XL in corridors

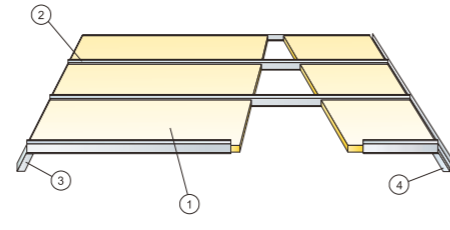

© Ecophon Group

M46
Installation diagram (M46) for Ecophon Focus A XL

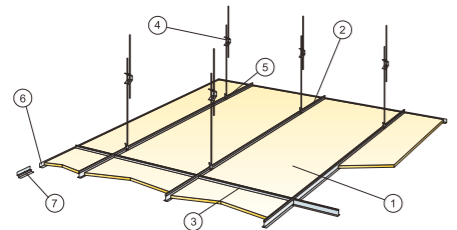

© Ecophon Group

M399
Installation diagram (M399) for Ecophon Focus A

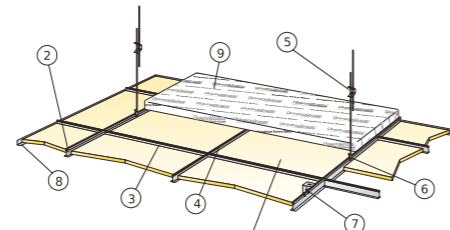

© Ecophon Group

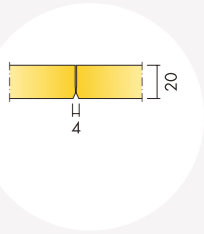

Ecophon Focus™ B

Acoustics:

Sound Absorption:

Test results according to EN ISO 354. Classification according to EN ISO 11654, and the single value ratings for Noise Reduction Coefficient, NRC and Sound Absorption Average, SAA according to ASTM C 423.

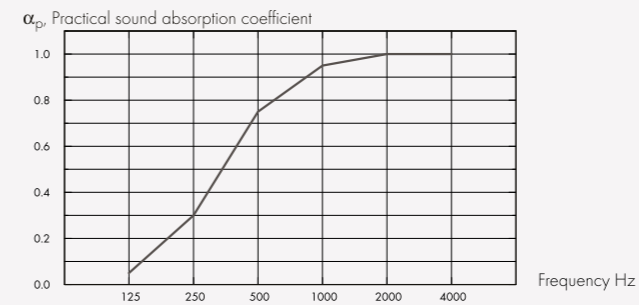

— Focus B 20 mm, 23 mm o.d.s.
o.d.s = overall depth of system

THK mm	o.d.s. mm	α_p , Practical sound absorption coefficient						α_w	Sound absorption class
		125 Hz	250 Hz	500 Hz	1000 Hz	2000 Hz	4000 Hz		
20	23	0.05	0.30	0.75	0.95	1.00	1.00	0.60	C

THK mm	o.d.s. mm	NRC	SAA	
-	20	23	0.75	0.76

Indoor Air Quality:

Certificate / Label	
Eurofins Indoor Air Comfort®	IAC
French VOC	A
Finnish M1	•

Indoor Air Quality:

Certificate / Label
In collaboration with the Allergy, Skin and Asthma Association

Environmental Footprint: Life-cycle stages A1 to C4 from EPD, in conformity with ISO 14025 / EN 15865 Focus B: 4,10,

Circularity: Minimum post-consumer recycled content: 56%, Recyclability: Fully recyclable,

Fire safety: The glass wool core of the tiles is tested and classified as non-combustible according to EN ISO 1182. Europe: EN 13501-1, A2-s1,d0,

Humidity Resistance: Class C, relative humidity 95% and 30°C, according to EN 13964:2014

Visual appearance: White Frost, nearest NCS colour sample S 0500-N, 85% light reflectance. Gloss < 1.

Cleanability: Daily dusting and vacuum cleaning. Weekly wet wiping.

Accessibility: The tiles are not demountable.

Installation: Installed according to installation diagrams, installation guides and drawing aid. For information regarding minimum overall depth of system see quantity specification. Rendered surfaces must have sufficient strength to be able to carry the load imposed by the tiles. If doubts, test gluing should be carried out. The surface should always be dry and clean. For best result the surface should be even.

System weight: The weight of the system should be approximately 2,5 kg/m²

Mechanical properties: Additional live load has to be fixed to the soffit.

CE: Ecophon ceiling systems are CE marked according to the European harmonized standard EN13964:2014. CE marked construction products are covered by a Declaration of Performance (DOP) which enables customers and users to easily compare performance of products available on the European market.

Installation diagram in detail www.ecophon.com

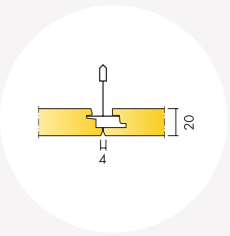
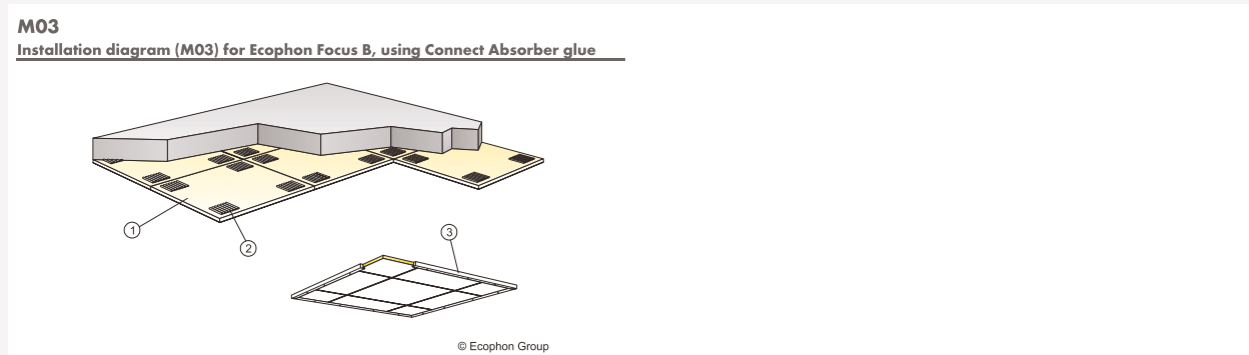

Ecophon Focus™ Ds

Acoustics:

Sound Absorption:

Test results according to EN ISO 354. Classification according to EN ISO 11654, and the single value ratings for Noise Reduction Coefficient, NRC and Sound Absorption Average, SAA according to ASTM C 423.

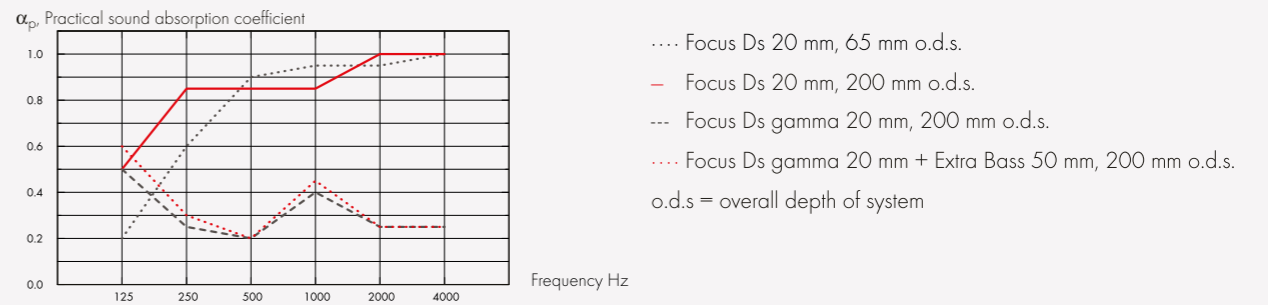

	THK mm	o.d.s. mm	α_p Practical sound absorption coefficient						α_w	Sound absorption class
			125 Hz	250 Hz	500 Hz	1000 Hz	2000 Hz	4000 Hz		
-	20	65	0.20	0.60	0.90	0.95	0.95	1.00	0.90	A
-	20	200	0.50	0.85	0.85	0.85	1.00	1.00	0.90	A
gamma	20	200	0.50	0.25	0.20	0.40	0.25	0.25	0.25	E
gamma+ Extra Bass	70	200	0.60	0.30	0.20	0.45	0.25	0.25	0.25	E

	THK mm	o.d.s. mm	NRC	SAA
-	20	65	0.90	0.89
gamma	20	200	0.30	0.28
gamma+ Extra Bass	70	200	0.30	0.29
-	20	400	0.80	0.82

THK mm	AC(1.5) Articulation Class, ASTM E1111, ASTM E1110	D_{nfw} Weighted normalized flanking level difference, ISO 10848-2	CAC dB Ceiling Attenuation Class, ASTM 1414, ASTM E413
20	180	24	25

Indoor Air Quality:

Certificate / Label	
Eurofins Indoor Air Comfort®	IAC
French VOC	A
Finnish M1	•

Indoor Air Quality:

Certificate / Label

In collaboration with the Allergy, Skin and Asthma Association

Environmental Footprint: Life-cycle stages A1 to C4 from EPD, in conformity with ISO 14025 / EN 15865 Focus Ds: 4,60,

Circularity: Minimum post-consumer recycled content: 57%, Recyclability: Fully recyclable,

Fire safety: The glass wool core of the tiles is tested and classified as non-combustible according to EN ISO 1182. Europe: EN 13501-1, A2-s1,d0,

Humidity Resistance: Class C, relative humidity 95% and 30°C, according to EN 13964:2014

Visual appearance: White Frost, nearest NCS colour sample S 0500-N, 85% light reflectance. Gloss < 1.

Cleanability: Daily dusting and vacuum cleaning. Weekly wet wiping.

Accessibility: The tiles in size 600x600 and 1200x600 are easily demountable. The tiles in size 1200x1200 and XL sizes are demountable. Minimum demounting depth according to installation diagrams.

Installation: Installed according to installation diagrams, installation guides and drawing aid. For information regarding minimum overall depth of system see quantity specification. The systems are not recommended for small rooms (approximately 2x2 m²). Ceilings with a large amount of integrations require careful planning, design and installation.

System weight: The weight of the system (including suspension grid) should be approximately 3-4 kg/m².

Mechanical properties: See table about Max live load and Min load bearing capacity and Functional demands, Mechanical properties at www.ecophon.com.

CE: Ecophon ceiling systems are CE marked according to the European harmonized standard EN13964:2014. CE marked construction products are covered by a Declaration of Performance (DOP) which enables customers and users to easily compare performance of products available on the European market.

Installation diagram in detail www.ecophon.com

M206
Installation diagram (M206) for Ecophon Focus Ds 600x600, 1200x600 mm and Ecophon Focus Ds XL. Suspended installation

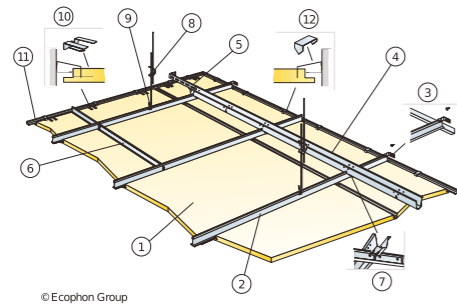

M206DIN
Installation diagram (M206DIN) for Ecophon Focus Ds 625x625, 1250x625 mm. Suspended installation

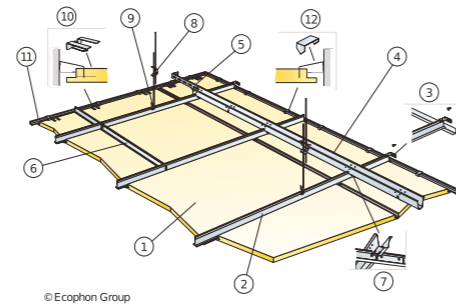

M207
Installation diagram (M207) for Ecophon Focus Ds 1200x1200 mm

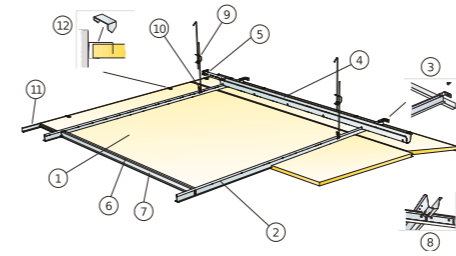

M208
Installation diagram (M208) for Ecophon Focus Ds, direct installation

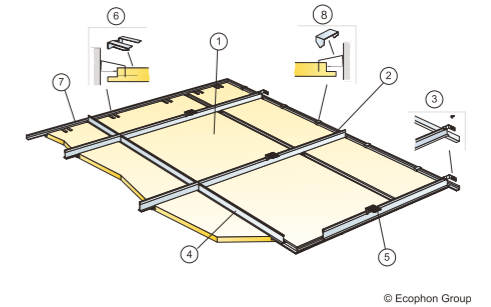

M238
Installation diagram (M238) for Ecophon Focus Ds XL in corridors

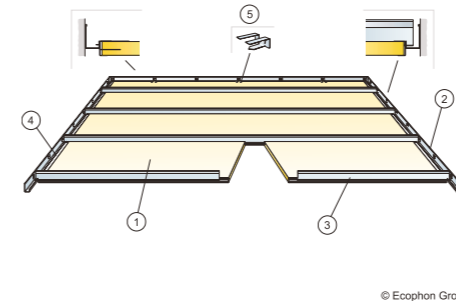

M394
Installation diagram (M394) for Ecophon Focus Ds Level change

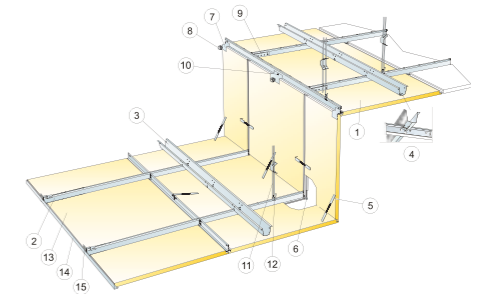

M400
Installation diagram (M400) for Ecophon Focus Ds

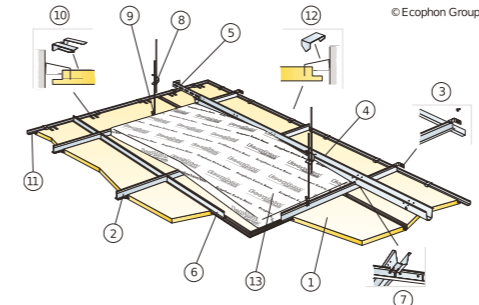

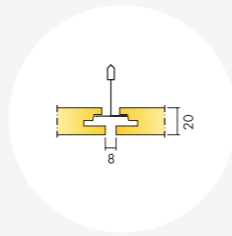

Ecophon Focus™ Dg

Acoustics:

Sound Absorption:

Test results according to EN ISO 354. Classification according to EN ISO 11654, and the single value ratings for Noise Reduction Coefficient, NRC and Sound Absorption Average, SAA according to ASTM C 423.

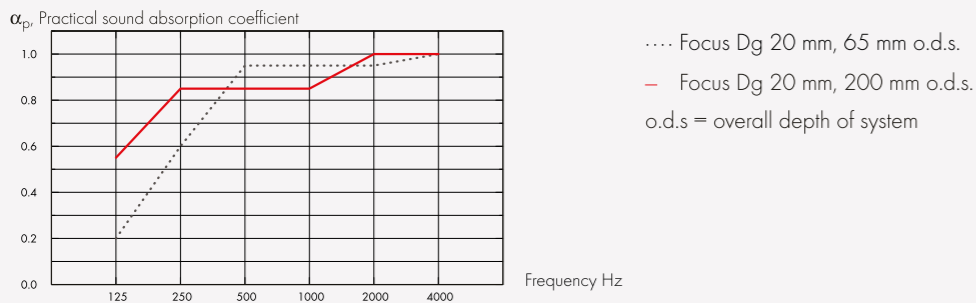

THK mm	o.d.s. mm	α_p Practical sound absorption coefficient						α_w	Sound absorption class
		125 Hz	250 Hz	500 Hz	1000 Hz	2000 Hz	4000 Hz		
20	65	0.20	0.60	0.95	0.95	0.95	1.00	0.90	A
20	200	0.55	0.85	0.85	0.85	1.00	1.00	0.90	A

	THK mm	o.d.s. mm	NRC	SAA
-	20	65	0.90	0.89
-	20	400	0.80	0.82

THK mm	AC(1.5)
20	180

Articulation Class, ASTM E1111, ASTM E1110

Indoor Air Quality:

Certificate / Label
 Eurofins Indoor Air Comfort® IAC
 French VOC A
 Finnish M1 •

Indoor Air Quality:

Certificate / Label
 In collaboration with the Allergy, Skin and Asthma Association

Environmental Footprint: Life-cycle stages A1 to C4 from EPD, in conformity with ISO 14025 / EN 15865 Focus Dg: 4,20,

Circularity: Minimum post-consumer recycled content: 59%, Recyclability: Fully recyclable,

Fire safety: The glass wool core of the tiles is tested and classified as non-combustible according to EN ISO 1182. Europe: EN 13501-1, A2-s1,d0,

Humidity Resistance: Class C, relative humidity 95% and 30°C, according to EN 13964:2014

Visual appearance: White Frost, nearest NCS colour sample S 0500-N, 85% light reflectance. Gloss < 1.

Cleanability: Daily dusting and vacuum cleaning. Weekly wet wiping.

Accessibility: The tiles in size 600x600 and 1200x600 are easily demountable. The tiles in size 1200x1200 and XL sizes are demountable. Minimum demounting depth according to installation diagrams.

Installation: Installed according to installation diagrams, installation guides and drawing aid. For information regarding minimum overall depth of system see quantity specification. The systems are not recommended for small rooms (approximately 2x2 m²). Ceilings with a large amount of integrations require careful planning, design and installation.

System weight: The weight of the system (including suspension grid) should be approximately 3-4 kg/m².

Mechanical properties: See table about Max live load and Min load bearing capacity and Functional demands, Mechanical properties at www.ecophon.com.

CE: Ecophon ceiling systems are CE marked according to the European harmonized standard EN13964:2014. CE marked construction products are covered by a Declaration of Performance (DOP) which enables customers and users to easily compare performance of products available on the European market.

Installation diagram in detail www.ecophon.com

M202
 Installation diagram (M202) for Ecophon Focus Dg 600x600, 1200x600 mm

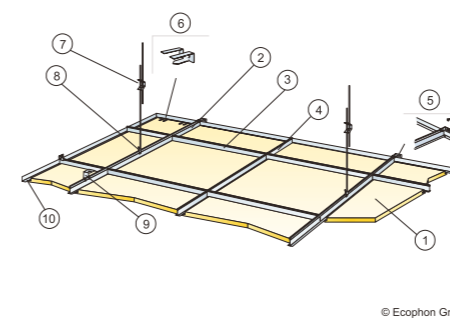

M202DIN
 Installation diagram (M202DIN) for Ecophon Focus Dg 625x625, 1250x625 mm

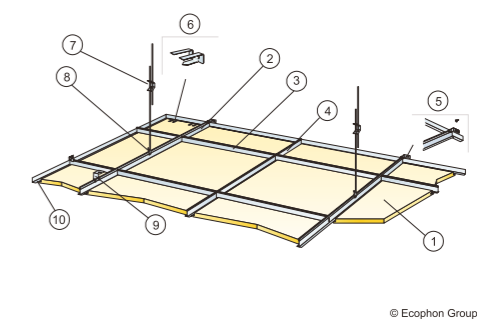

M203
 Installation diagram (M203) for Ecophon Focus Dg 1200x1200 mm

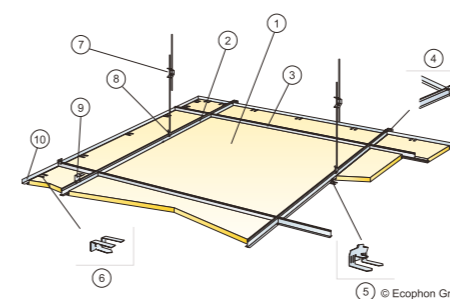

M204
 Installation diagram (M204) for Ecophon Focus Dg XL

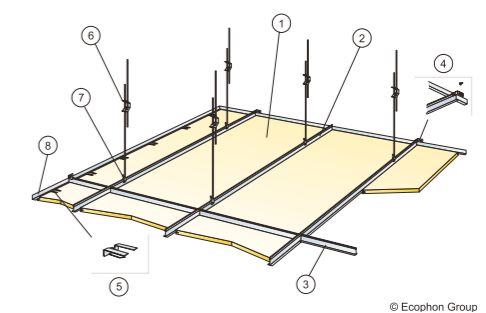

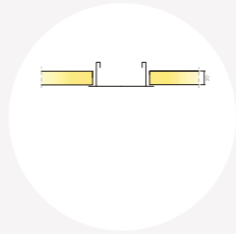

Ecophon Focus™ D/A

Acoustics:

Sound Absorption:

Test results according to EN ISO 354. Classification according to EN ISO 11654, and the single value ratings for Noise Reduction Coefficient, NRC and Sound Absorption Average, SAA according to ASTM C 423.

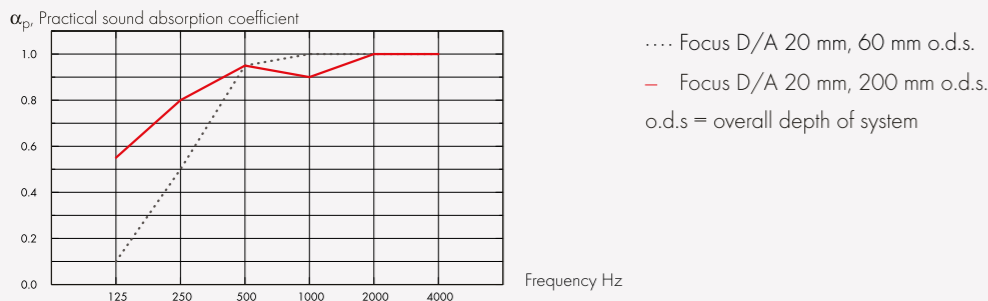

THK mm	o.d.s. mm	α_p Practical sound absorption coefficient						α_w	Sound absorption class
		125 Hz	250 Hz	500 Hz	1000 Hz	2000 Hz	4000 Hz		
20	60	0.10	0.50	0.95	1.00	1.00	1.00	0.80	A
20	200	0.55	0.80	0.95	0.90	1.00	1.00	0.95	A

	THK mm	o.d.s. mm	NRC	SAA
-	20	60	0.90	0.89
-	20	400	0.80	0.82

THK mm	AC(1.5) Articulation Class, ASTM E1111, ASTM E1110	D_{nfw} Weighted normalized flanking level difference, ISO 10848-2	CAC dB Ceiling Attenuation Class, ASTM 1414, ASTM E413
20	180	24	25

Indoor Air Quality:

Certificate / Label

Eurofins Indoor Air Comfort®	IAC
French VOC	A
Finnish M1	•

Indoor Air Quality:

Certificate / Label

In collaboration with the Allergy, Skin and Asthma Association

Environmental Footprint: Life-cycle stages A1 to C4 from EPD, in conformity with ISO 14025 / EN 15828 Focus DA: 4,32 ,

Circularity: Minimum post-consumer recycled content: 57%, Recyclability: Fully recyclable,

Fire safety: The glass wool core of the tiles is tested and classified as non-combustible according to EN ISO 1182. Europe: EN 13501-1, A2-s1,d0,

Humidity Resistance: Class C, relative humidity 95% and 30°C, according to EN 13964:2014

Visual appearance: White Frost, nearest NCS colour sample S 0500-N, 85% light reflectance. Gloss < 1.

Cleanability: Daily dusting and vacuum cleaning. Weekly wet wiping.

Accessibility: The tiles are easily demountable. Minimum demounting depth according to installation diagrams.

Installation: Installed according to installation diagram and bandraster/grid supplier recommendations.

System weight: The weight of the system (including suspension grid) should be approximately 2 kg/m².

Mechanical properties: See table about Max live load and Min load bearing capacity and Functional demands, Mechanical properties at www.ecophon.com.

CE: Ecophon ceiling systems are CE marked according to the European harmonized standard EN13964:2014. CE marked construction products are covered by a Declaration of Performance (DOP) which enables customers and users to easily compare performance of products available on the European market.

Installation diagram in detail www.ecophon.com

M17

Installation diagram (M17) for Focus D/A in corridor

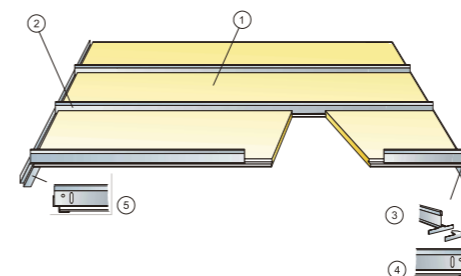

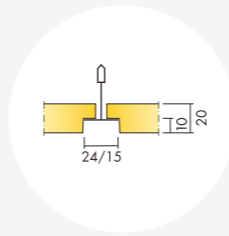

Ecophon Focus™ E

Acoustics:

Sound Absorption:

Test results according to EN ISO 354. Classification according to EN ISO 11654, and the single value ratings for Noise Reduction Coefficient, NRC and Sound Absorption Average, SAA according to ASTM C 423.

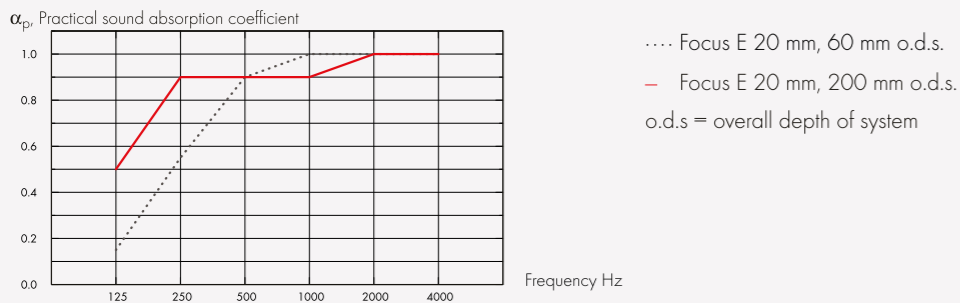

THK mm	o.d.s. mm	α_p Practical sound absorption coefficient						α_w	Sound absorption class
		125 Hz	250 Hz	500 Hz	1000 Hz	2000 Hz	4000 Hz		
20	60	0.15	0.55	0.90	1.00	1.00	1.00	0.85	B
20	200	0.50	0.90	0.90	0.90	1.00	1.00	0.95	A

	THK mm	o.d.s. mm	NRC	SAA
-	20	60	0.90	0.87
-	20	400	0.85	0.85

THK mm	AC(1.5)		D_{nfw}	CAC dB
	Articulation Class, ASTM E1111, ASTM E1110			
20	180		22	23

Weighted normalized flanking level difference, ISO 10848-2
Ceiling Attenuation Class, ASTM 1414, ASTM E413

Indoor Air Quality:

Certificate / Label	Standard	Plant
Eurofins Indoor Air Comfort®	IAC	IAC Gold
French VOC	A	A+
Finnish M1	•	•

Environmental Footprint: Life-cycle stages A1 to C4 from EPD, in conformity with ISO 14025 / EN 15812 Focus E: 3,66 , Focus E/Plant: 2,35,

Circularity: Minimum post-consumer recycled content: 55%, Recyclability: Fully recyclable,

Fire safety: The glass wool core of the tiles is tested and classified as non-combustible according to EN ISO 1182. Europe: EN 13501-1, A2-s1,d0,

Humidity Resistance: According to EN 13964:2014 Standard: Class C, RH 95% and 30°C, Plant: Class A, RH 70% and 25°C,

Visual appearance: White Frost, nearest NCS colour sample S 0500-N, 85% light reflectance. Gloss < 1.

Cleanability: Daily dusting and vacuum cleaning. Weekly wet wiping.

Accessibility: The tiles are easily demountable. Minimum demounting depth according to installation diagrams.

Installation: Installed according to installation diagrams, installation guides and drawing aid. For information regarding minimum overall depth of system see quantity specification.

System weight: The weight of the system (including suspension grid) should be approximately 3 kg/m².

Mechanical properties: See table about Max live load and Min load bearing capacity and Functional demands, Mechanical properties at www.ecophon.com.

CE: Ecophon ceiling systems are CE marked according to the European harmonized standard EN13964:2014. CE marked construction products are covered by a Declaration of Performance (DOP) which enables customers and users to easily compare performance of products available on the European market.

Installation diagram in detail www.ecophon.com

M12

Installation diagram (M12) for Ecophon Focus E

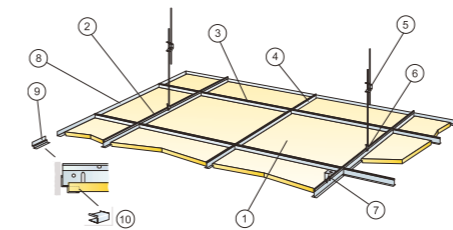

© Ecophon Group

M12QL

Installation diagram (M12) for Ecophon Focus E with Quick-Lock grid system

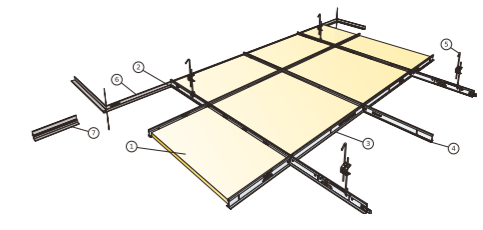

M12 DIN

Installation diagram (M12 DIN) for Ecophon Focus E

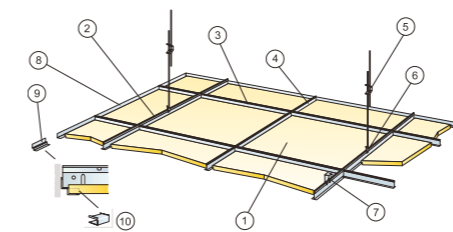

© Ecophon Group

M47

Installation diagram (M47) for Ecophon Focus E XL

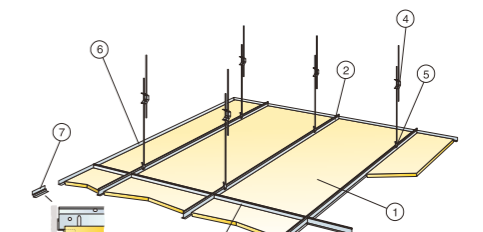

© Ecophon Group

M49
Installation diagram (M49) for Ecophon Focus E XL in corridors

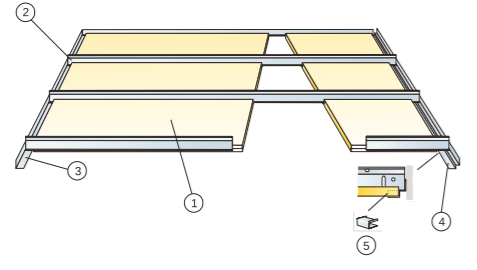

© Ecophon Group

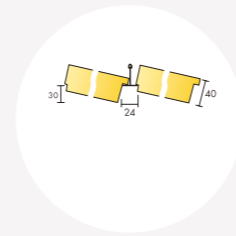

Ecophon Focus™ Ez

Acoustics:

Sound Absorption:

Test results according to EN ISO 354. Classification according to EN ISO 11654, and the single value ratings for Noise Reduction Coefficient, NRC and Sound Absorption Average, SAA according to ASTM C 423.

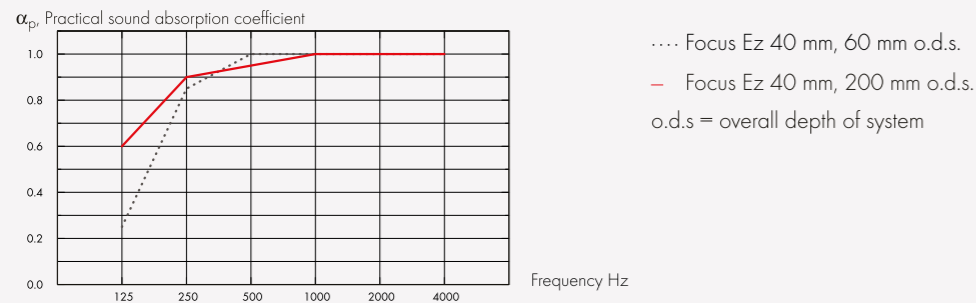

THK mm	o.d.s. mm	α_p Practical sound absorption coefficient						α_w	Sound absorption class
		125 Hz	250 Hz	500 Hz	1000 Hz	2000 Hz	4000 Hz		
40	60	0.25	0.85	1.00	1.00	1.00	1.00	1.00	A
40	200	0.60	0.90	0.95	1.00	1.00	1.00	1.00	A

	THK mm	o.d.s. mm	NRC	SAA
-	40	60	1.00	0.99
-	40	200	1.00	0.97

THK mm	AC(1.5)		D_{nfw}		CAC dB	
	Articulation Class, ASTM E1111, ASTM E1110		Weighted normalized flanking level difference, ISO 10848-2		Ceiling Attenuation Class, ASTM 1414, ASTM E413	
40	200		29		31	

Indoor Air Quality:

Certificate / Label

Eurofins Indoor Air Comfort®	IAC
French VOC	A
Finnish M1	•

Indoor Air Quality:

Certificate / Label

In collaboration with the Allergy, Skin and Asthma Association

Environmental Footprint: Life-cycle stages A1 to C4 from EPD, in conformity with ISO 14025 / EN 15860 Focus Ez: 5,9 ,

Circularity: Minimum post-consumer recycled content: 62%, Recyclability: Fully recyclable,

Fire safety: The glass wool core of the tiles is tested and classified as non-combustible according to EN ISO 1182. Europe: EN 13501-1, A2-s1,d0,

Humidity Resistance: Class C, relative humidity 95% and 30°C, according to EN 13964:2014

Visual appearance: White Frost, nearest NCS colour sample S 0500-N, 85% light reflectance. Gloss < 1.

Cleanability: Daily dusting and vacuum cleaning. Weekly wet wiping.

Accessibility: The tiles are easily demountable. Minimum demounting depth according to installation diagrams.

Installation: Installed according to installation diagrams, installation guides and drawing aid. For information regarding minimum overall depth of system see quantity specification.

System weight: The weight of the system (including suspension grid) should be approximately 5 kg/m²

Mechanical properties: See table about Max live load and Min load bearing capacity and Functional demands, Mechanical properties at www.ecophon.com.

CE: Ecophon ceiling systems are CE marked according to the European harmonized standard EN13964:2014. CE marked construction products are covered by a Declaration of Performance (DOP) which enables customers and users to easily compare performance of products available on the European market.

Installation diagram in detail www.ecophon.com

M393

Installation diagram (M393) for Ecophon Focus Ez

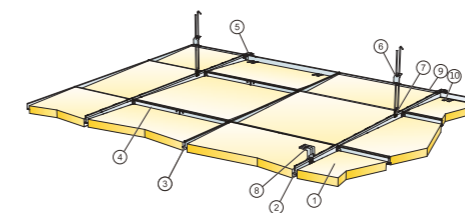

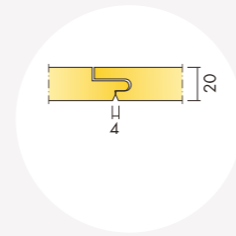

Ecophon Focus™ F

Acoustics:

Sound Absorption:

Test results according to EN ISO 354. Classification according to EN ISO 11654, and the single value ratings for Noise Reduction Coefficient, NRC and Sound Absorption Average, SAA according to ASTM C 423.

α_p , Practical sound absorption coefficient

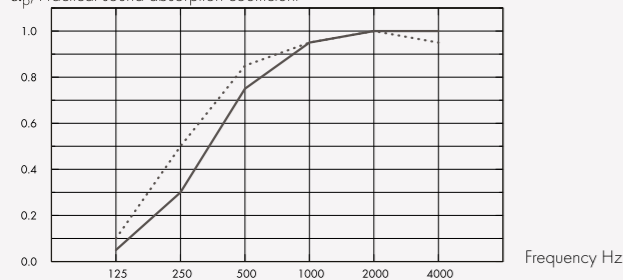

— Focus F 20 mm, 20 mm o.d.s.
 Focus F 20 mm, 40 mm o.d.s.
 o.d.s = overall depth of system

THK mm	o.d.s. mm	α_p , Practical sound absorption coefficient						α_w	Sound absorption class
		125 Hz	250 Hz	500 Hz	1000 Hz	2000 Hz	4000 Hz		
20	20	0.05	0.30	0.75	0.95	1.00	1.00	0.60	C
20	40	0.10	0.50	0.85	0.95	1.00	0.95	0.80	B

	THK mm	o.d.s. mm	NRC	SAA
-	20	20	0.75	0.76
-	20	40	0.85	0.82

Indoor Air Quality:

Certificate / Label

Eurofins Indoor Air Comfort®	IAC
French VOC	A
Finnish M1	•

Indoor Air Quality:

Certificate / Label

In collaboration with the Allergy, Skin and Asthma Association

Environmental Footprint: Life-cycle stages A1 to C4 from EPD, in conformity with ISO 14025 / EN 15865 Focus F: 4,90,

Circularity: Minimum post-consumer recycled content: 59%, Recyclability: Fully recyclable,

Fire safety: The glass wool core of the tiles is tested and classified as non-combustible according to EN ISO 1182. Europe: EN 13501-1, A2-s1,d0,

Humidity Resistance: Class C, relative humidity 95% and 30°C, according to EN 13964:2014

Visual appearance: White Frost, nearest NCS colour sample S 0500-N, 85% light reflectance. Gloss < 1.

Cleanability: Daily dusting and vacuum cleaning. Weekly wet wiping.

Accessibility: The tiles are not demountable.

Installation: Installed according to installation diagrams, installation guides and drawing aid. For information regarding minimum overall depth of system see quantity specification. For best result the surface should be even, however an acceptable result could be achieved on slightly uneven surfaces. If very uneven surfaces – installation of furring (evenly spaced timber battens) as the substrate for the tiles is recommended.

System weight: The weight of the system should be approximately 2,5 kg/m²

Mechanical properties: Additional live load has to be fixed to the soffit.

CE: Ecophon ceiling systems are CE marked according to the European harmonized standard EN 13964:2014. CE marked construction products are covered by a Declaration of Performance (DOP) which enables customers and users to easily compare performance of products available on the European market.

Installation diagram in detail www.ecophon.com

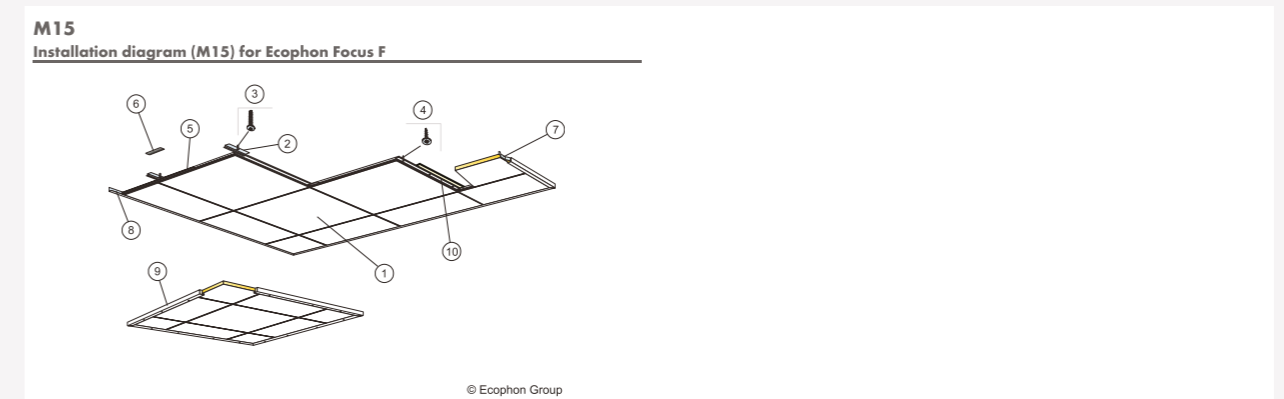

© Ecophon Group

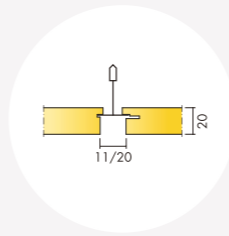

Ecophon Focus™ Lp

Acoustics:

Sound Absorption:

Test results according to EN ISO 354. Classification according to EN ISO 11654, and the single value ratings for Noise Reduction Coefficient, NRC and Sound Absorption Average, SAA according to ASTM C 423.

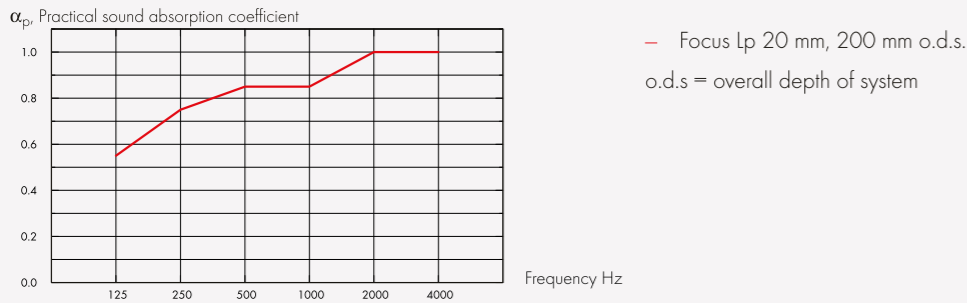

THK mm	o.d.s. mm	α _p Practical sound absorption coefficient						α _w	Sound absorption class
		125 Hz	250 Hz	500 Hz	1000 Hz	2000 Hz	4000 Hz		
20	200	0.55	0.75	0.85	0.85	1.00	1.00	0.90	A

THK mm	o.d.s. mm	NRC	SAA
-	20	0.80	0.82

THK mm	AC(1.5) Articulation Class, ASTM E1111, ASTM E1110	D _{nfw} Weighted normalized flanking level difference, ISO 10848-2	CAC dB Ceiling Attenuation Class, ASTM 1414, ASTM E413
20	180	24	25

Indoor Air Quality:

Certificate / Label	
Eurofins Indoor Air Comfort®	IAC
French VOC	A
Finnish M1	•

Indoor Air Quality:

Certificate / Label
In collaboration with the Allergy, Skin and Asthma Association

Environmental Footprint: Life-cycle stages A1 to C4 from EPD, in conformity with ISO 14025 / EN 15865 Focus Lp: 4,66,

Circularity: Minimum post-consumer recycled content: 57%, Recyclability: Fully recyclable,

Fire safety: The glass wool core of the tiles is tested and classified as non-combustible according to EN ISO 1182. Europe: EN 13501-1, A2-s1,d0,

Humidity Resistance: Class C, relative humidity 95% and 30°C, according to EN 13964:2014

Visual appearance: White Frost, nearest NCS colour sample S 0500-N, 85% light reflectance. Gloss < 1.

Cleanability: Daily dusting and vacuum cleaning. Weekly wet wiping.

Accessibility: The tiles are easily demountable. Minimum demounting depth according to installation diagrams.

Installation: Installed according to installation diagrams, installation guides and drawing aid. For information regarding minimum overall depth of system see quantity specification. The systems are not recommended for small rooms (approximately 2x2 m²). Ceilings with a large amount of integrations require careful planning, design and installation.

System weight: The weight of the system (including suspension grid) should be approximately 3-4 kg/m².

Mechanical properties: See table about Max live load and Min load bearing capacity and Functional demands, Mechanical properties at www.ecophon.com. For the Technical tiles installed according to M391 there is a load bearing capacity of 100 N for each Main runner per 1200 mm. This gives a total load bearing capacity of 200 N for a load evenly distributed on two Main runners.

CE: Ecophon ceiling systems are CE marked according to the European harmonized standard EN13964:2014. CE marked construction products are covered by a Declaration of Performance (DOP) which enables customers and users to easily compare performance of products available on the European market.

Installation diagram in detail www.ecophon.com

M390

Installation diagram (M390) for Ecophon Focus Lp

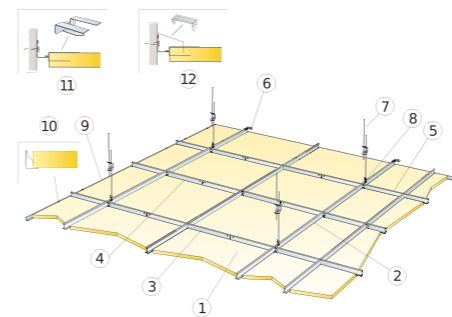

M391

Installation diagram (M391) for Ecophon Focus Lp Technical tile

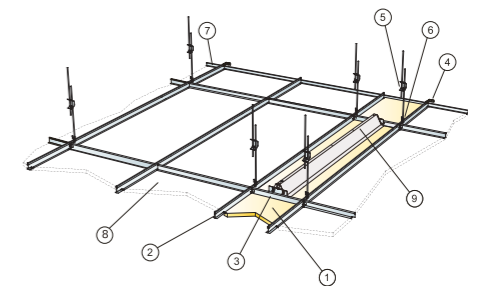

M392

Installation diagram (M392) for Ecophon Focus Lp XL

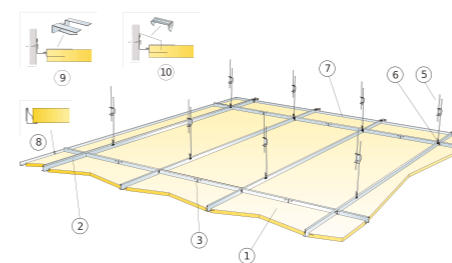

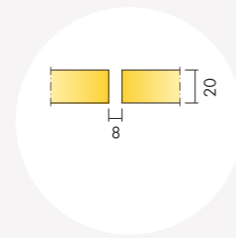

Ecophon Focus™ SQ

Acoustics:

Sound Absorption:

Test results according to EN ISO 354. Classification according to EN ISO 11654, and the single value ratings for Noise Reduction Coefficient, NRC and Sound Absorption Average, SAA according to ASTM C 423.

α_p , Practical sound absorption coefficient

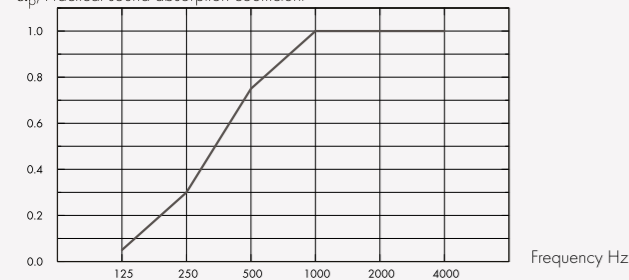

— Focus SQ 20 mm, 23 mm o.d.s.
o.d.s = overall depth of system

THK mm	o.d.s. mm	α_p Practical sound absorption coefficient						α_w	Sound absorption class
		125 Hz	250 Hz	500 Hz	1000 Hz	2000 Hz	4000 Hz		
20	23	0.05	0.30	0.75	1.00	1.00	1.00	0.60	C

THK mm	o.d.s. mm	NRC	SAA
20	23	0.75	0.78

THK mm	AC(1.5)
20	190

Articulation Class, ASTM E1111, ASTM E1110

Indoor Air Quality:

Certificate / Label

Eurofins Indoor Air Comfort®	IAC
French VOC	A
Finnish M1	•

Indoor Air Quality:

Certificate / Label

In collaboration with the Allergy, Skin and Asthma Association

Environmental Footprint: Life-cycle stages A1 to C4 from EPD, in conformity with ISO 14025 / EN 15865 Focus SQ: 4,88,

Circularity: Minimum post-consumer recycled content: 57%, Recyclability: Fully recyclable,

Fire safety: The glass wool core of the tiles is tested and classified as non-combustible according to EN ISO 1182. Europe: EN 13501-1, A2-s1,d0,

Humidity Resistance: Class C, relative humidity 95% and 30°C, according to EN 13964:2014

Visual appearance: White Frost, nearest NCS colour sample S 0500-N, 85% light reflectance. Gloss < 1.

Cleanability: Daily dusting and vacuum cleaning. Weekly wet wiping.

Accessibility: The tiles are not demountable.

Installation: Installed according to installation diagrams, installation guides and drawing aid. For information regarding minimum overall depth of system see quantity specification. Rendered surfaces must have sufficient strength to be able to carry the load imposed by the tiles. If doubts, test gluing should be carried out. The surface should always be dry and clean. For best result the surface should be even, however an acceptable result could be achieved on slightly uneven surfaces.

System weight: The weight of the system should be approximately 2,5 kg/m²

Mechanical properties: Additional live load has to be fixed to the soffit.

CE: Ecophon ceiling systems are CE marked according to the European harmonized standard EN13964:2014. CE marked construction products are covered by a Declaration of Performance (DOP) which enables customers and users to easily compare performance of products available on the European market.

Installation diagram in detail www.ecophon.com

M107

Installation diagram (M107) for Ecophon Focus SQ, using Connect Absorber glue

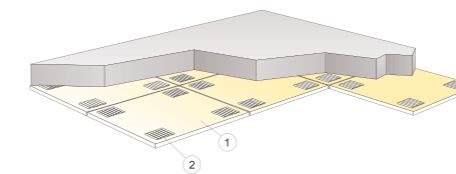

© Ecophon Group

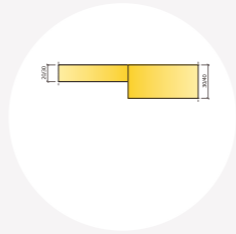

Ecophon Focus™ Levels

Acoustics:

Sound Absorption:

Test results according to EN ISO 354. Classification according to EN ISO 11654, and the single value ratings for Noise Reduction Coefficient, NRC and Sound Absorption Average, SAA according to ASTM C 423.

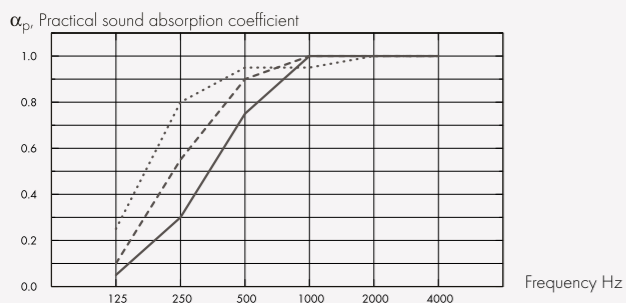

···· Focus Levels 40 mm, 43 mm o.d.s.
 --- Focus Levels 30 mm, 33 mm o.d.s.
 — Focus Levels 20 mm, 23 mm o.d.s.
 o.d.s = overall depth of system

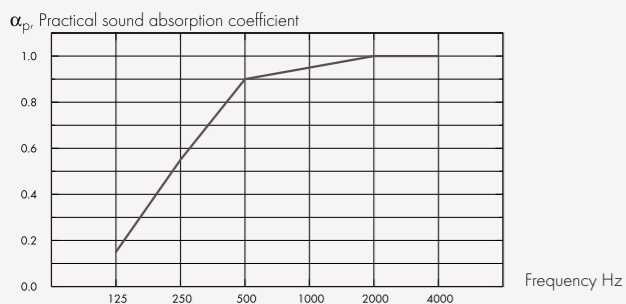

— Focus Levels 20/30/40 mm (M488, M489), 23-43 mm o.d.s.
 o.d.s = overall depth of system

THK mm	o.d.s. mm	α_p , Practical sound absorption coefficient						α_w	Sound absorption class
		125 Hz	250 Hz	500 Hz	1000 Hz	2000 Hz	4000 Hz		
40	43	0.25	0.80	0.95	0.95	1.00	1.00	A	
30	33	0.10	0.55	0.90	1.00	1.00	1.00	B	
20	23	0.05	0.30	0.75	1.00	1.00	1.00	C	
0	43	0.15	0.55	0.90	0.95	1.00	1.00	B	

THK mm	o.d.s. mm	NRC	SAA
-	20	0.75	0.78

Indoor Air Quality:

Certificate / Label

Eurofins Indoor Air Comfort®	IAC
French VOC	A
Finnish M1	•

Indoor Air Quality:

Certificate / Label

In collaboration with the Allergy, Skin and Asthma Association

Environmental Footprint: Life-cycle stages A1 to C4 from EPD, in conformity with ISO 14025 / EN 15793 Focus Levels 20mm: 5,03 , Focus Levels 30mm: 6,23, Focus Levels 40mm: 7,44 ,

Circularity: Minimum post-consumer recycled content (20 mm): 58%, Minimum post-consumer recycled content (30 mm): 62%, Minimum post-consumer recycled content (40 mm): 64%, Recyclability: Fully recyclable,

Fire safety: The glass wool core of the tiles is tested and classified as non-combustible according to EN ISO 1182. Europe: EN 13501-1, A2-s1,d0,

Humidity Resistance: Class C, relative humidity 95% and 30°C, according to EN 13964:2014

Visual appearance: White Frost, nearest NCS colour sample S 0500-N, 85% light reflectance. Gloss < 1.

Cleanability: Daily dusting and vacuum cleaning. Weekly wet wiping.

Accessibility: The tiles are not demountable.

Installation: Installed according to installation diagrams, installation guides and drawing aid. For information regarding minimum overall depth of system see quantity specification. Rendered surfaces must have sufficient strength to be able to carry the load imposed by the tiles. If doubts, test gluing should be carried out. The surface should always be dry and clean. For best result the surface should be even, however an acceptable result could be achieved on slightly uneven surfaces.

Mechanical properties: Additional live load has to be fixed to the soffit.

CE: Ecophon ceiling systems are CE marked according to the European harmonized standard EN13964:2014. CE marked construction products are covered by a Declaration of Performance (DOP) which enables customers and users to easily compare performance of products available on the European market.

Installation diagram in detail www.ecophon.com

M488

Installation diagram (M488) for Ecophon Focus Levels, using Connect Absorber glue

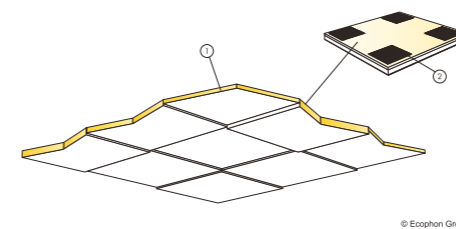

M489

Installation diagram (M489) for Ecophon Focus Levels, using Connect Absorber glue

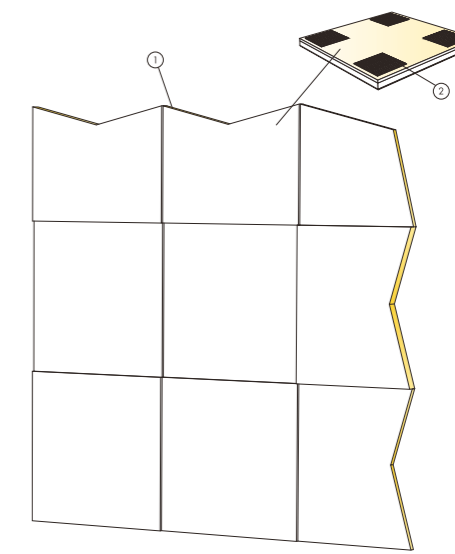

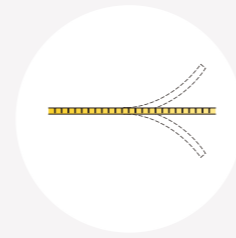

Ecophon Focus™ Flexiform A

Acoustics: Acoustic values corresponding to a flat ceiling.

Sound Absorption:

Test results according to EN ISO 354. Classification according to EN ISO 11654, and the single value ratings for Noise Reduction Coefficient, NRC and Sound Absorption Average, SAA according to ASTM C 423.

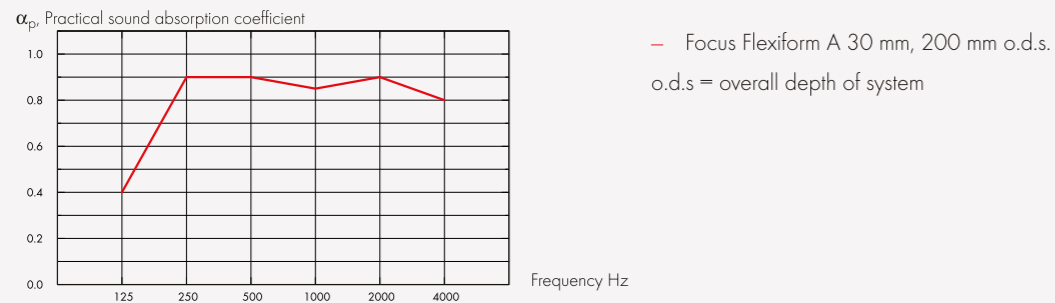

THK mm	o.d.s. mm	α_p Practical sound absorption coefficient						α_w	Sound absorption class
		125 Hz	250 Hz	500 Hz	1000 Hz	2000 Hz	4000 Hz		
30	200	0.40	0.90	0.90	0.85	0.90	0.80	0.90	A

THK mm	D_{nfw}		CAC dB
	Weighted normalized flanking level difference, ISO 10848-2		
20	24		25

Indoor Air Quality:

Certificate / Label

In collaboration with the Allergy, Skin and Asthma Association

Environmental Footprint: Life-cycle stages A1 to C4 from EPD, in conformity with ISO 14025 / EN 15808 Focus Flexiform A: 3,1 ,

Circularity: Minimum post-consumer recycled content: 39%, Recyclability: Fully recyclable,

Fire safety: The glass wool core of the tiles is tested and classified as non-combustible according to EN ISO 1182. Europe: EN 13501-1, A2-s1,d0,

Humidity Resistance: Class C, relative humidity 95% and 30°C, according to EN 13964:2014

Visual appearance: White Frost, nearest NCS colour sample S 0500-N, 85% light reflectance. Gloss < 1.

Cleanability: Daily dusting and vacuum cleaning. Weekly wet wiping.

Accessibility: The tiles are not demountable.

Installation: Installed according to installation diagrams, installation guides and drawing aid. (Please note: Extreme incident light, near windows or other light sources, can create undesired shadow effects on the structured surface on curved installations.)

System weight: The weight is approximately 3 kg/m², depending on the installation method.

Mechanical properties: Additional live load has to be fixed to the soffit.

CE: Ecophon ceiling systems are CE marked according to the European harmonized standard EN13964:2014. CE marked construction products are covered by a Declaration of Performance (DOP) which enables customers and users to easily compare performance of products available on the European market.

Installation diagram in detail www.ecophon.com

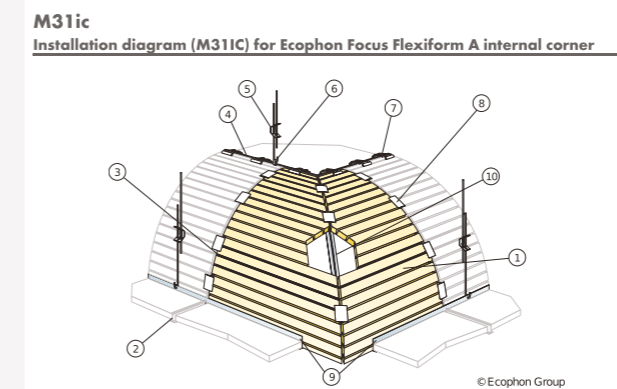
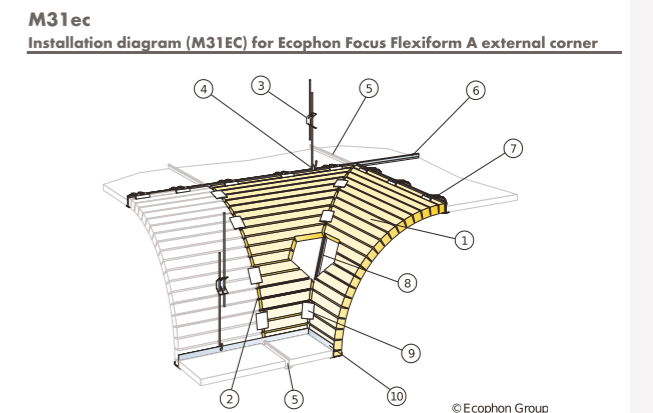
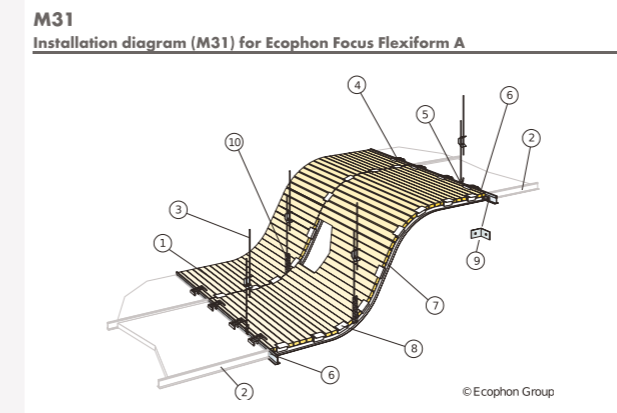

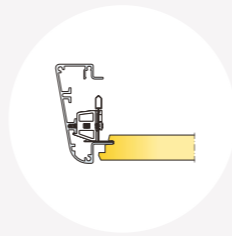

Ecophon Focus Edge™ 500

Acoustics: Ecophon Focus Edge 500 is a perimeter component. For acoustic data on the system - please see corresponding ceiling system (Focus Ds, Focus Dg or Focus/Master E).

Circularity: Fully recyclable

Fire safety: Europe: EN 13501-1, A1,

Installation: Installed according to installation diagrams, installation guides and drawing aid. For information regarding minimum overall depth of system see quantity specification.

Mechanical properties: Additional live load has to be fixed to the soffit.

CE: Ecophon ceiling systems are CE marked according to the European harmonized standard EN13964:2014. CE marked construction products are covered by a Declaration of Performance (DOP) which enables customers and users to easily compare performance of products available on the European market.

Installation diagram in detail www.ecophon.com

M165
Installation diagram (M165) for Ecophon Edge 500 with Focus E T24

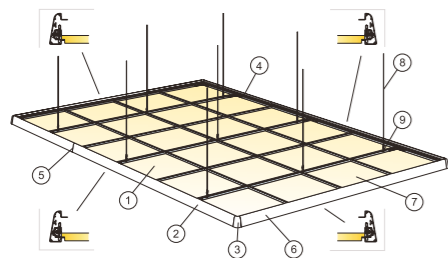

© Ecophon Group

M210
Installation diagram (M210) for Ecophon Edge 500 with Focus Ds

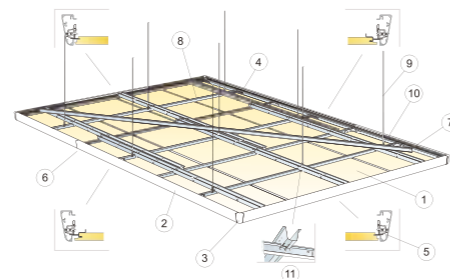

M211
Installation diagram (M211) for Ecophon Edge 500 with Focus Dg

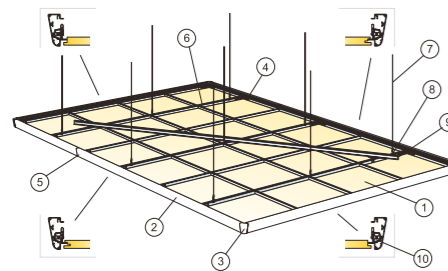

© Ecophon Group

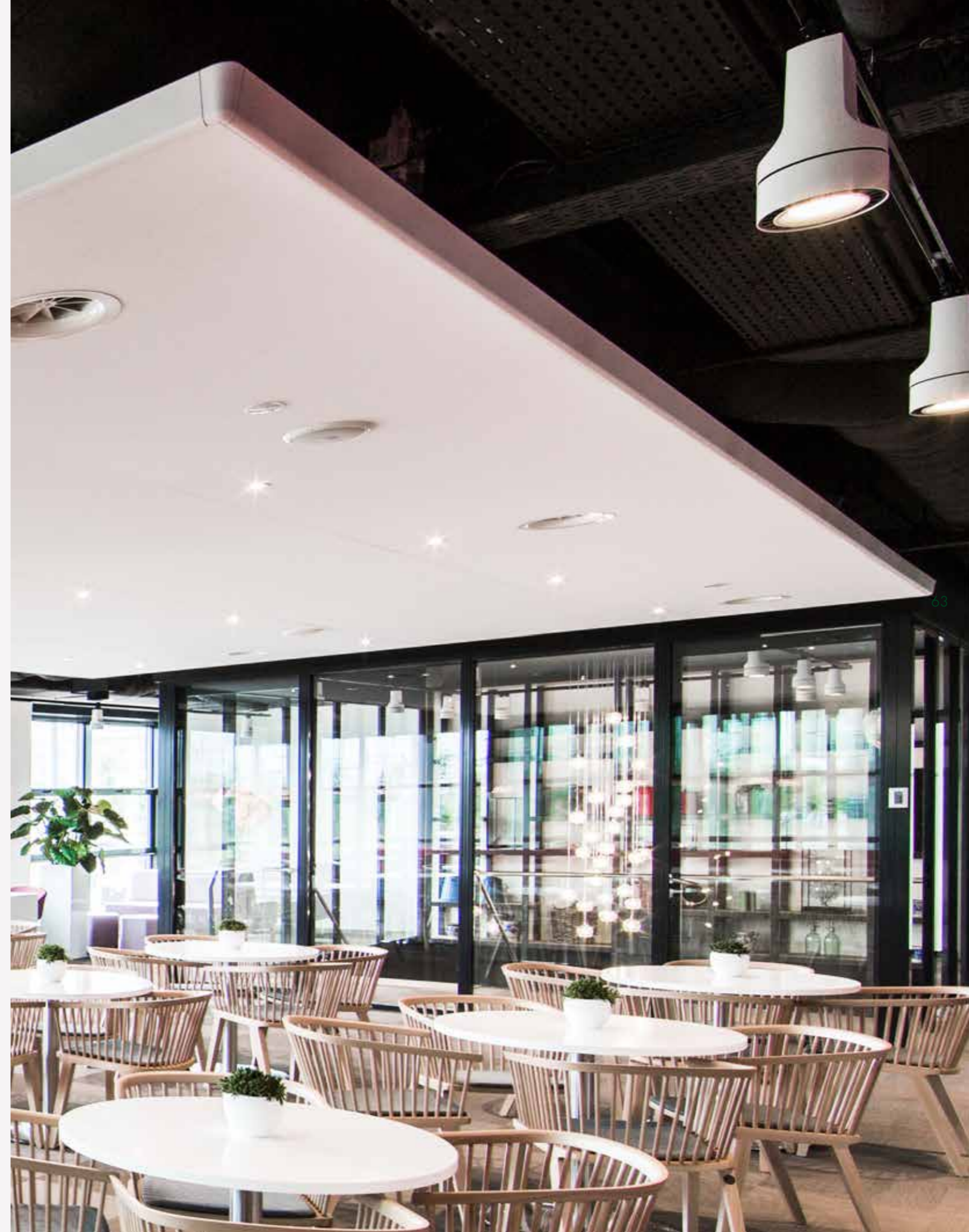

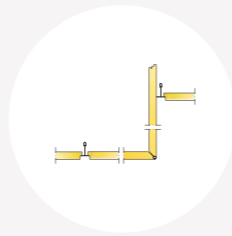

Ecophon Focus™ Fixiform E

Acoustics: Acoustic values corresponding to a flat ceiling.

Sound Absorption:

Test results according to EN ISO 354. Classification according to EN ISO 11654, and the single value ratings for Noise Reduction Coefficient, NRC and Sound Absorption Average, SAA according to ASTM C 423.

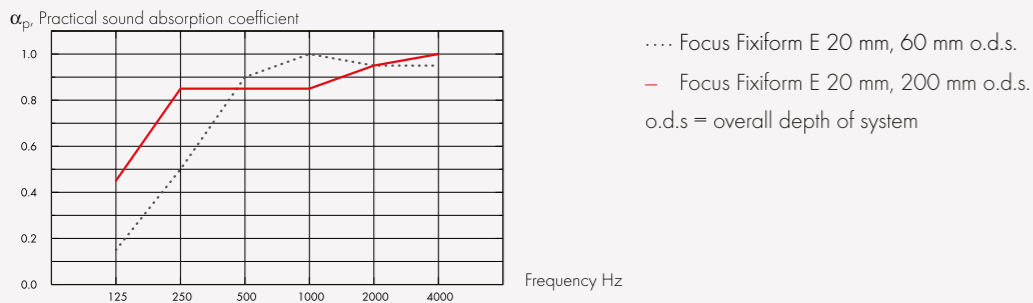

THK mm	o.d.s. mm	α _p Practical sound absorption coefficient						α _w	Sound absorption class
		125 Hz	250 Hz	500 Hz	1000 Hz	2000 Hz	4000 Hz		
20	60	0.15	0.50	0.90	1.00	0.95	0.95	0.80	B
20	200	0.45	0.85	0.85	0.85	0.95	1.00	0.90	A

THK mm	D _{nfw}		CAC dB	
	Weighted normalized flanking level difference, ISO 10848-2		Ceiling Attenuation Class, ASTM 1414, ASTM E413	
20	24		25	

Indoor Air Quality:

Certificate / Label	
Eurofins Indoor Air Comfort®	IAC
French VOC	A
Finnish M1	•

Indoor Air Quality:

Certificate / Label
In collaboration with the Allergy, Skin and Asthma Association

Circularity: Minimum post-consumer recycled content: 57%, Recyclability: Fully recyclable,

Fire safety: The glass wool core of the tiles is tested and classified as non-combustible according to EN ISO 1182. Europe: EN 13501-1, A2-s1,d0,

Humidity Resistance: Class C, relative humidity 95% and 30°C, according to EN 13964:2014

Visual appearance: White Frost, nearest NCS colour sample S 0500-N, 85% light reflectance. Gloss < 1.

Cleanability: Daily dusting and vacuum cleaning. Weekly wet wiping.

Accessibility: The panels are demountable via adjacent flat ceiling tiles.

Installation: Installed according to installation diagrams, installation guides and drawing aid. Focus Fixiform E is supplied with all necessary installation accessories.

Mechanical properties: Additional live load has to be fixed to the soffit.

CE: Ecophon ceiling systems are CE marked according to the European harmonized standard EN13964:2014. CE marked construction products are covered by a Declaration of Performance (DOP) which enables customers and users to easily compare performance of products available on the European market.

Installation diagram in detail www.ecophon.com

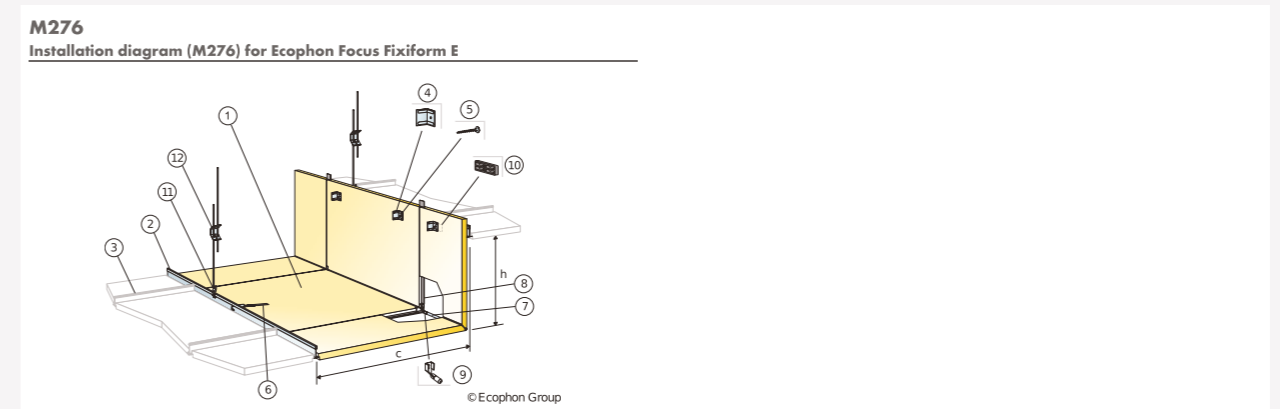

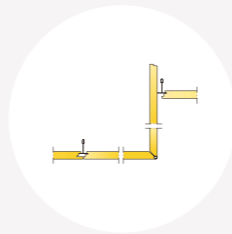

Ecophon Focus™ Fixiform Ds

Acoustics: Acoustic values corresponding to a flat ceiling.

Sound Absorption:

Test results according to EN ISO 354. Classification according to EN ISO 11654.

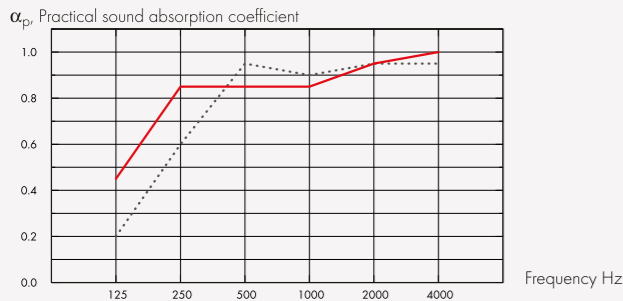

..... Focus Fixiform Ds 20 mm, 75 mm o.d.s.
 — Focus Fixiform Ds 20 mm, 200 mm o.d.s.
 o.d.s = overall depth of system

THK mm	o.d.s. mm	α _p Practical sound absorption coefficient						α _w	Sound absorption class
		125 Hz	250 Hz	500 Hz	1000 Hz	2000 Hz	4000 Hz		
20	75	0.20	0.60	0.95	0.90	0.95	0.95	0.90	A
20	200	0.45	0.85	0.85	0.85	0.95	1.00	0.90	A

THK mm	D _{nfw}		CAC dB	
	Weighted normalized flanking level difference, ISO 10848-2		Ceiling Attenuation Class, ASTM 1414, ASTM E413	
20	24		25	

Indoor Air Quality:

Certificate / Label
 Eurofins Indoor Air Comfort® IAC
 French VOC A
 Finnish M1 •

Indoor Air Quality:

Certificate / Label
 In collaboration with the Allergy, Skin and Asthma Association

Circularity: Minimum post-consumer recycled content: 57%, Recyclability: Fully recyclable,

Fire safety: The glass wool core of the tiles is tested and classified as non-combustible according to EN ISO 1182. Europe: EN 13501-1, A2-s1,d0,

Humidity Resistance: Class C, relative humidity 95% and 30°C, according to EN 13964:2014

Visual appearance: White Frost, nearest NCS colour sample S 0500-N, 85% light reflectance. Gloss < 1.

Cleanability: Daily dusting and vacuum cleaning. Weekly wet wiping.

Accessibility: The panels are demountable via adjacent flat ceiling tiles.

Installation: Installed according to installation diagrams, installation guides and drawing aid. Focus Fixiform Ds is supplied with all necessary installation accessories.

Mechanical properties: Additional live load has to be fixed to the soffit.

CE: Ecophon ceiling systems are CE marked according to the European harmonized standard EN13964:2014. CE marked construction products are covered by a Declaration of Performance (DOP) which enables customers and users to easily compare performance of products available on the European market.

Installation diagram in detail www.ecophon.com

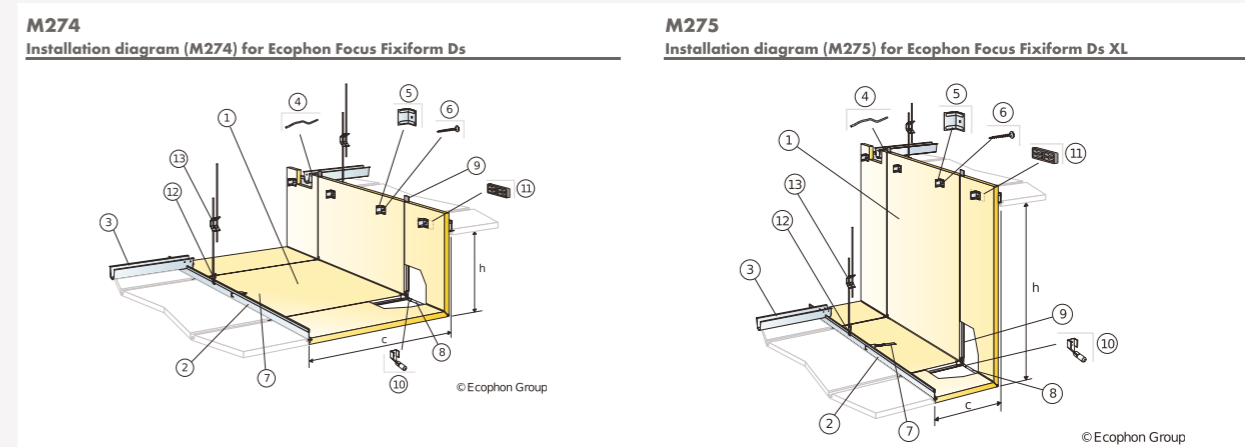

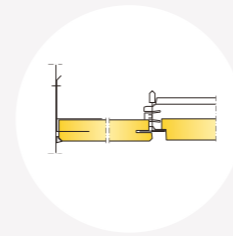

Ecophon Focus™ Frieze

Acoustics:

Sound Absorption:

Test results according to EN ISO 354. Classification according to EN ISO 11654, and the single value ratings for Noise Reduction Coefficient, NRC and Sound Absorption Average, SAA according to ASTM C 423.

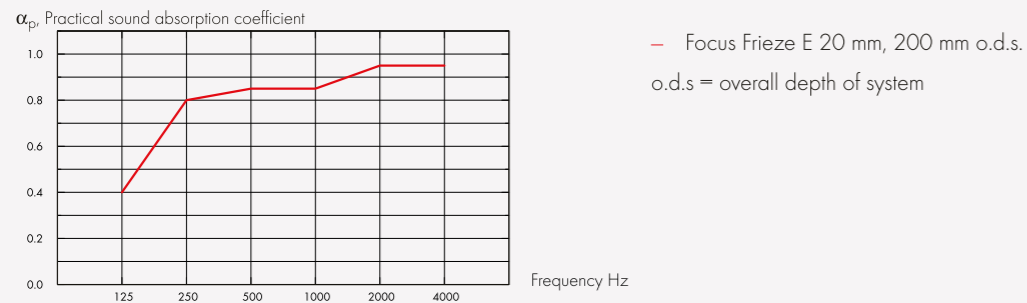

THK mm	o.d.s. mm	α_p Practical sound absorption coefficient						α_w	Sound absorption class
		125 Hz	250 Hz	500 Hz	1000 Hz	2000 Hz	4000 Hz		
20	200	0.40	0.80	0.85	0.85	0.95	0.95	0.90	A

THK mm	AC(1.5) Articulation Class, ASTM E1111, ASTM E1110	D_{nfw} Weighted normalized flanking level difference, ISO 10848-2	CAC dB Ceiling Attenuation Class, ASTM 1414, ASTM E413
20	190	24	25

Indoor Air Quality:

Certificate / Label

Eurofins Indoor Air Comfort®	IAC
French VOC	A
Finnish M1	•

Indoor Air Quality:

Certificate / Label

In collaboration with the Allergy, Skin and Asthma Association

Circularity: Minimum post-consumer recycled content: 59%, Recyclability: Fully recyclable,

Fire safety: The glass wool core of the tiles is tested and classified as non-combustible according to EN ISO 1182. Europe: EN 13501-1, A2-s1,d0,

Humidity Resistance: Class C, relative humidity 95% and 30°C, according to EN 13964:2014

Visual appearance: White Frost, nearest NCS colour sample S 0500-N, 85% light reflectance. Gloss < 1.

Cleanability: Daily dusting and vacuum cleaning. Weekly wet wiping.

Accessibility: The tiles are not demountable.

Installation: Installed according to installation diagrams, installation guides and drawing aid. For information regarding minimum overall depth of system see quantity specification.

System weight: The system consists of Ecophon Focus™ frieze tiles and Connect™ grid systems, with an approximate weight of 3 kg/m².

Mechanical properties: See table about Max live load and Min load bearing capacity and Functional demands, Mechanical properties at www.ecophon.com.

CE: Ecophon ceiling systems are CE marked according to the European harmonized standard EN 13964:2014. CE marked construction products are covered by a Declaration of Performance (DOP) which enables customers and users to easily compare performance of products available on the European market.

Installation diagram in detail www.ecophon.com

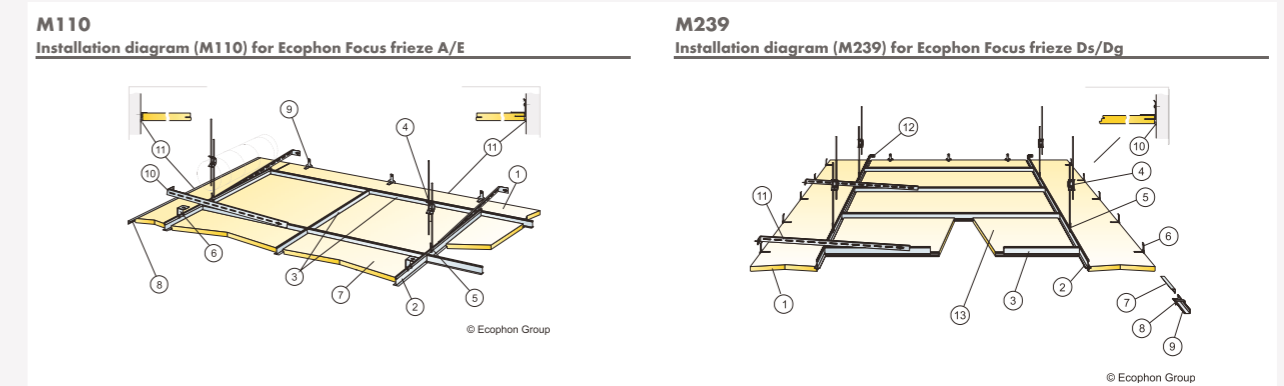

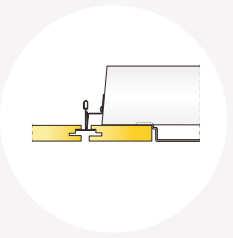
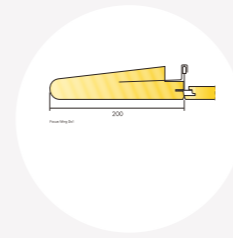

Ecophon Focus™ Wing

Acoustics: Ecophon Focus Wing is a perimeter component. As such it is absorbent, however, for acoustic data on the system - please see corresponding ceiling system (Focus Ds or Focus/Master E).

Indoor Air Quality:

Certificate / Label

Eurofins Indoor Air Comfort® IAC Gold
French VOC A+

Circularity: Minimum post-consumer recycled content: 61%, Recyclability: Fully recyclable,

Fire safety: The glass wool core of the tiles is tested and classified as non-combustible according to EN ISO 1182. Europe: EN 13501-1, A2-s1,d0,

Humidity Resistance: Class C, relative humidity 95% and 30°C, according to EN 13964:2014

Visual appearance: White Frost, nearest NCS colour sample S 0500-N, 85% light reflectance. Gloss < 1.

Cleanability: Daily dusting and vacuum cleaning. Weekly wet wiping.

Accessibility: The tiles are not demountable.

Installation: Installed according to installation diagrams, installation guides and drawing aid. For information regarding minimum overall depth of system see quantity specification.

System weight: The systems consist of Ecophon Focus™ Wing elements and Connect™ grid systems, with an approximate weight of 1 kg/m.

Mechanical properties: No additional live load is allowed.

CE: Ecophon ceiling systems are CE marked according to the European harmonized standard EN13964:2014. CE marked construction products are covered by a Declaration of Performance (DOP) which enables customers and users to easily compare performance of products available on the European market.

Installation diagram in detail www.ecophon.com

Ecophon Square 43™

Lighting performance:

System effect: 40,7 W
Light source: LED 37 W
Luminous flux: 3307 lm
Light efficiency: 81 lm/W
Colour temperature: 4000K
Color rendering index: > 80 Ra
Colour tolerance: 3 MacAdam SDCM
Light output ratio (LOR): 100%
Light distribution up/down: 0/100
Expected lifespan: L90 >50000 h
Expected lifespan: L70 >100000 h

Electrical data: 220-240 V, 50-60 Hz, power factor $\cos \phi > 0,98$. Electronic HF ballast or electronic HF dim ballast for digital regulation. Light source: 2 led modules of 37W total. Also available as emergency light, with a battery pack for one hour.

Connection: The standard on/off electronic HF ballast delivered with 2,5 meters of cable 2,5 metres of cable 2x0,75 mm² and Euro plugg. The SwitchDIM/DALI and emergency electronic HF ballast delivered without cable. Emergency ballast with 1 hour battery pack.

Electrical approvals: IP23, Class 1.

Visual appearance: Tile surface finish; White Frost, nearest NCS colour sample S 0500-N, 85% light reflectance. Gloss < 1.

Cleanability: Daily dusting and vacuum cleaning. Weekly wet wiping.

Accessibility: The tiles are easily demountable. Minimum demounting depth according to installation diagrams.

Installation: Installed according to system range which include information regarding minimum overall depth of system. The luminaire housing rests on the T-profiles and the SwitchDIM/DALI and standard on/off ballasts are fastened to the grid or tile with velcro. The tile in which the louvre is integrated is installed as an ordinary ceiling tile. Once the luminaire, ballast and tile are in place a certified installation electrician must connect the wiring to sockets or to the next luminaire.

Installation diagram in detail www.ecophon.com

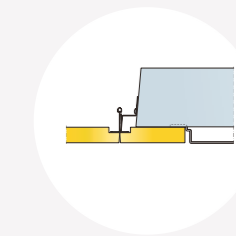
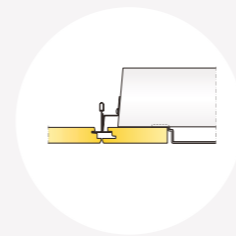

Ecophon Dot™

Lighting performance:

System effect: 40,7 W
 Light source: LED 41 W
 Luminous flux: 2610 lm
 Light efficiency: 64 lm/W
 Colour temperature: 4000K
 Color rendering index: Ra >80
 Colour tolerance: MacAdam 3 SDCM
 Light output ratio (LOR): 100%
 Light distribution up/down: 0/100
 Expected lifespan: L90 >50000 h
 Expected lifespan: L70 >100000 h

Electrical data: 220-240 V, 50-60 Hz, power factor $\cos \phi > 0,98$. Electronic HF ballast or electronic HF dim ballast for digital regulation. Light source: 2 led modules of 37W total. Also available as emergency light, with a battery pack for one hour.

Connection: The standard on/off electronic HF ballast delivered with 2,5 meters of cable 2,5 metres of cable 2x0,75 mm² and Euro plugg. The SwitchDIM/DALI and emergency electronic HF ballast delivered without cable. Emergency ballast with 1 hour battery pack.

Electrical approvals: IP23, Class 1.

Visual appearance: Tile surface finish; White Frost, nearest NCS colour sample S 0500-N, 85% light reflectance. Gloss < 1.

Cleanability: Daily dusting and vacuum cleaning. Weekly wet wiping.

Accessibility: The tiles are easily demountable. Minimum demounting depth according to installation diagrams.

Installation: Installed according to system range which include information regarding minimum overall depth of system. The luminaire housing rests on the T-profiles and the SwitchDIM/DALI and standard on/off ballasts are fastened to the grid or tile with velcro. The tile in which the louvre is integrated is installed as an ordinary ceiling tile. Once the luminaire, ballast and tile are in place a certified installation electrician must connect the wiring to sockets or to the next luminaire.

Installation diagram in detail www.ecophon.com

Ecophon Line™

Lighting performance:

System effect: 27,6 W
 Light source: LED 30 W
 Luminous flux: 3008 lm
 Light efficiency: 109 lm/W
 Colour temperature: 4000K
 Color rendering index: > 80 Ra
 Colour tolerance: 3 MacAdam SDCM
 Light output ratio (LOR): 100%
 Light distribution up/down: 0/100
 Expected lifespan: L90 >50000 h
 Expected lifespan: L70 >100000 h

Electrical data: 220-240 V, 50-60 Hz, power factor $\cos \phi > 0,98$. Electronic HF ballast or electronic HF dim ballast for digital regulation. Light source: 1 led module of 30W total. Also available as emergency light, with a battery pack for one hour.

Connection: The standard on/off electronic HF ballast delivered with 2,5 meters of cable 3x0,75 mm² and grounded plug. The SwitchDIM/DALI and emergency electronic HF ballast delivered without cable. Emergency ballast with 1 hour battery pack.

Electrical approvals: IP23, Class 1.

Visual appearance: Tile surface finish; White Frost, nearest NCS colour sample S 0500-N, 85% light reflectance. Gloss < 1.

Cleanability: Daily dusting and vacuum cleaning. Weekly wet wiping.

Accessibility: The tiles are easily demountable. Minimum demounting depth according to installation diagrams.

Installation: Installed according to system range which include information regarding minimum overall depth of system. The luminaire housing rests on the T-profiles and the SwitchDIM/DALI and standard on/off ballasts are fastened to the grid or tile with velcro. The tile in which the louvre is integrated is installed as an ordinary ceiling tile. Once the luminaire, ballast and tile are in place a certified installation electrician must connect the wiring to sockets or to the next luminaire.

Installation diagram in detail www.ecophon.com

Ecophon is the leading supplier of indoor acoustic solutions that improve working performance and quality of life. We believe in the difference sound can make to our everyday lives, and are passionate advocates for the importance of room acoustics to people's wellbeing – whatever the space, activity or need.

Having a sound effect on people is the principle that guides all we do. We're proud of the Swedish heritage and human approach that promise is founded on. Our uncompromising commitment to transparent sustainable practice. And, as members of the Saint-Gobain Group, to be doing our part in making the world a better home.

