

EXPLORING
A VERTICAL
ART VARIETY

ECOPHON AKUSTO™



Contents

04 ABOUT ECOPHON

06 GOOD ACCOUSTICS MATTER EVERYWHERE

08 BUILDING ON BETTER

10 EXPLORING A VERTICAL ART VARIETY WITH ECOPHON AKUSTO™

12 ECOPHON AKUSTO PRODUCT RANGE

- 13 Akusto Wall A
- 14 Akusto Wall C
- 15 Akusto Wall C Extra Bass
- 16 Akusto One
- 17 Akusto Screen

18 INSTALLATION METHODS

20 ECOPHON AKUSTO OVERVIEW

22 COLOURS AND SURFACES

26 SYSTEM PROPERTIES

Acoustics, technical properties and installation diagrams

This publication shows products from Ecophon product range and those of other suppliers. The specifications are intended to provide a general guide to which products are most suitable for the preferences indicated. Technical data is based on results obtained under typical testing conditions or long experience in normal conditions. The specified functions and properties for products and systems are only valid on condition that instructions, installation diagrams, installation guides, maintenance instructions and other stated conditions and recommendations have been taken into consideration and followed. Deviation from this, such as changing specific components or products, will mean that Ecophon cannot be held responsible for the function, consequences and properties of the products. All descriptions, illustrations and dimensions contained in this brochure represent general information and shall not form part of any contract. Ecophon reserves the right to change products without prior notice. We disclaim any liability for misprints. For the latest information go to www.ecophon.com or contact your nearest Ecophon representative.

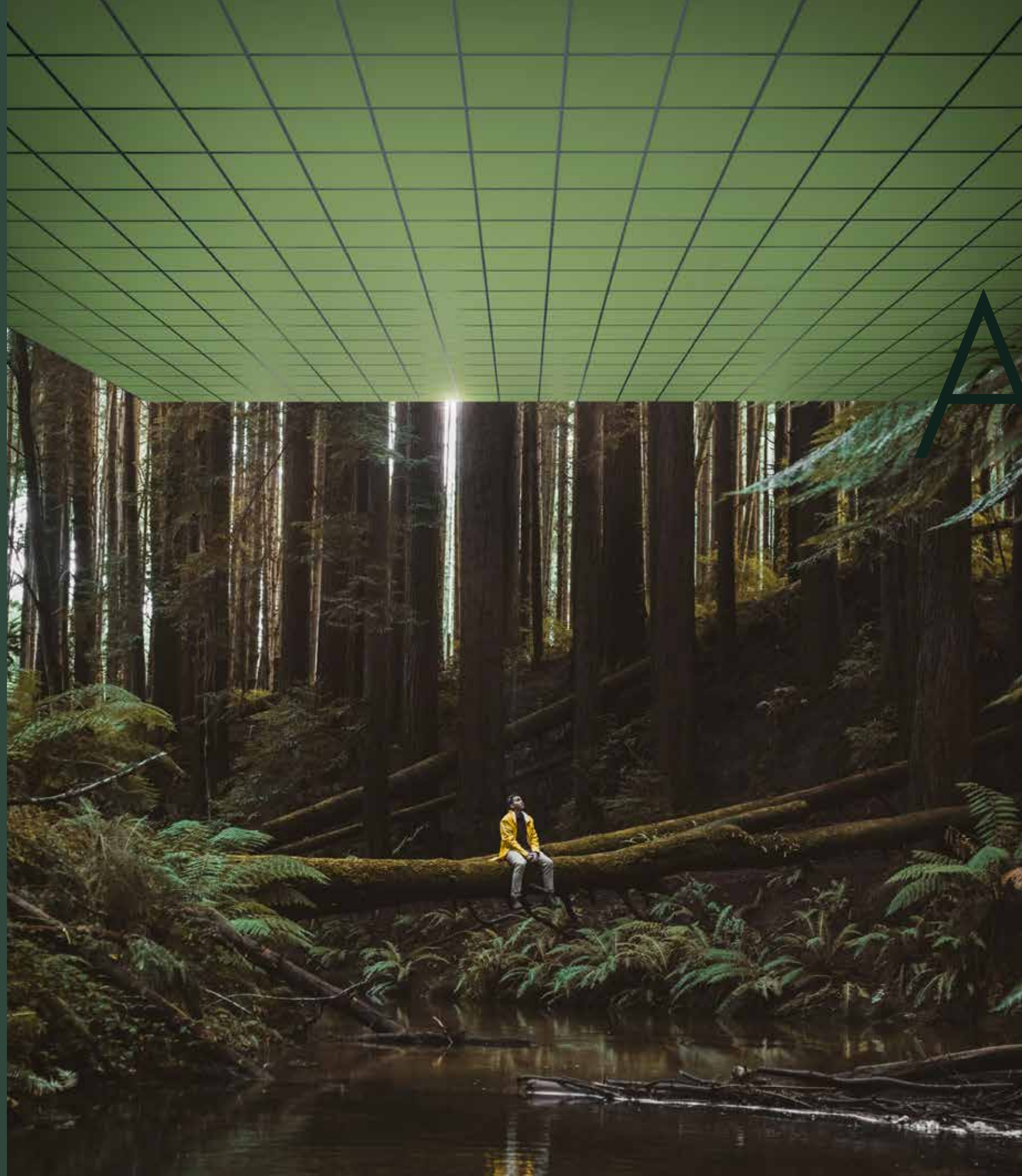

A Sound effect

ON PEOPLE

Saint-Gobain Ecophon contributes to good indoor environments for working, healing and learning. We do this by developing, manufacturing and delivering acoustic products and systems designed around the natural evolution of human hearing – replicating the outdoor sound experience indoors, because that’s just better for people.

Having a sound effect on people, in every way we can, is what we do proudly. That promise makes every one of us a passionate advocate for the importance of room acoustics to people’s wellbeing – whatever the space, activity or need.

Good acoustics

MATTER EVERYWHERE

The importance of acoustics is underappreciated. Sound impacts us in daily life, and the scientific support for improving our indoor sound environments is well-documented.

And what exactly is an ideal indoor sound environment for people? One based on how we experience sound outside. The human auditory sense is naturally adapted to an outdoor environment where there is not any sound reflections from ceilings and walls.

That's why most of what we do at Ecophon is about replicating the acoustic qualities found in nature for indoor environments. We want to optimise indoor spaces to our natural way of hearing, so that speech and sound is easy to hear and understand, when needed, improving performance and wellbeing.

Usually that starts with the ceiling. A wall-to-wall acoustic ceiling is the easiest way to get a large sound-absorbing surface area into a space, and is usually the best way to reduce sound strength, shorten reverberation times, and increase speech clarity and overall hearing comfort.

But for a truly optimal sound environment, you'll also likely need different kinds of sound absorbers placed strategically throughout the space—wall-mounted panels and free-standing dividers are just two examples. In other words, a holistic approach is the best way to reduce the overall sound level and sound propagation in a room. Ecophon is here to help.

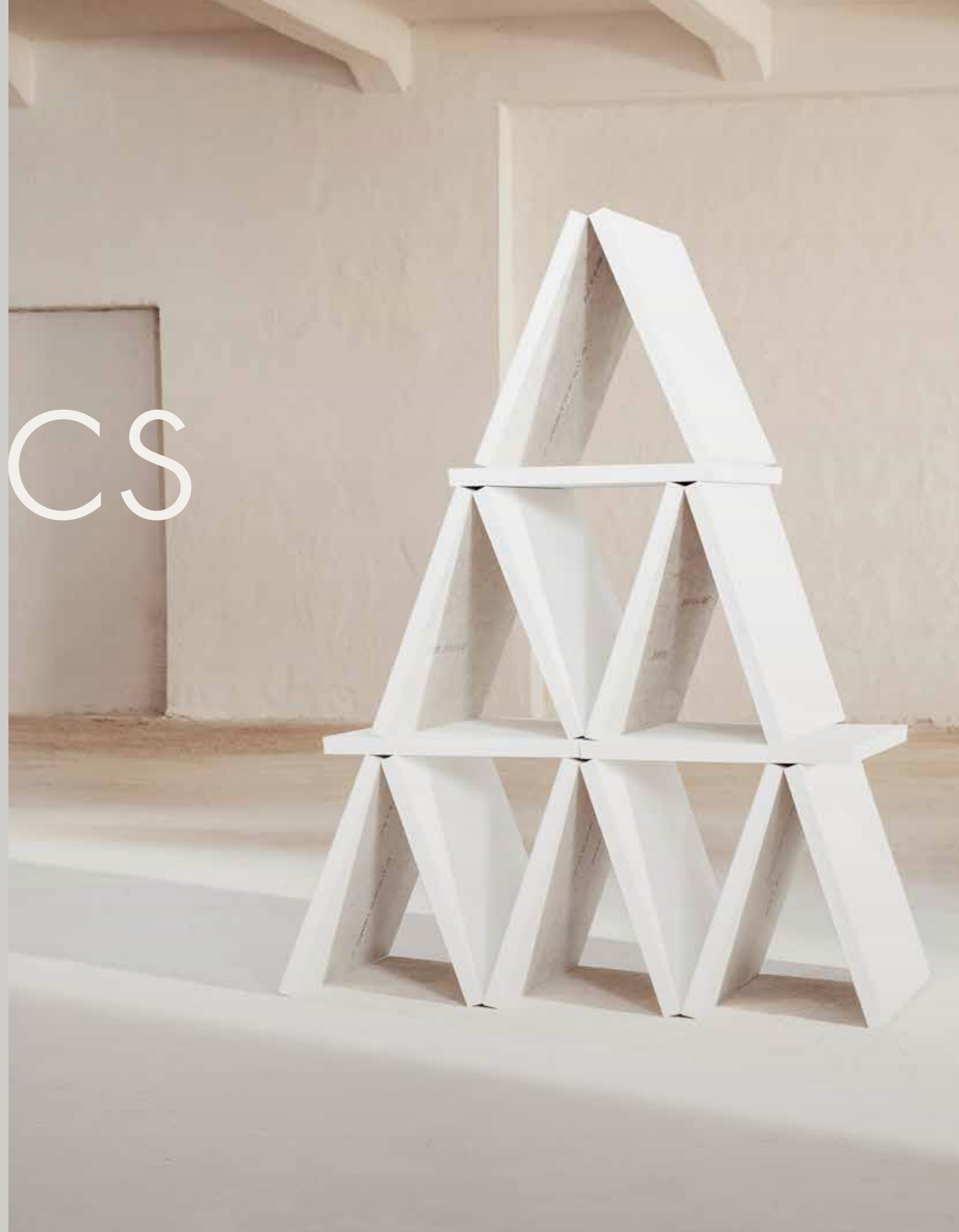

Building on

BETTER

Sustainability is more than a word – it's a collective movement to protect people and the planet that requires honest commitment and genuine care. That's why Ecophon is building on better materials, transparency, and principles, to name just a few.

We actively support an industry-wide drive to standardized, easy-access Environmental Product Declarations for individual products, rather than product families. Their inclusion of full lifecycle data, from raw material sourcing to end of life, rather than only the favorable stages. A move away from self-declared labels, or non-independently verified sustainability claims. And for any promises of net zero carbon emission targets to be validated by the Science-Based Targets initiative.

If we're going to build a sustainable future, it has to start with an honest approach, high ambition and the best of intentions – to build on better together.



Ecophon Akusto™

EXPLORING A VERTICAL ART VARIETY

Ecophon Akusto™ is a complement to acoustic ceilings that solves acoustic challenges and allows opportunities to follow current design and installation trends. The panel surface is available in Texona, Super G and Akutex FT.

- Excellent acoustics
- Wall and screen absorbers with many installation solutions
- A vertical solution in a variety of surfaces, colours and shapes

When designing a space for optimal acoustic performance, a sound-absorbing ceiling is the first priority – but bare walls will still create echoes. Akusto panels will solve this by absorbing sound and give clearer speech, lower sound strength, reduce sound propagation and take away flutter echoes.

With Akusto, it is easy to create workplaces where people feel good and can perform at their very best.

Our acoustic
absorber has minimum

48%

post-consumer recycled
content





ECOPHON AKUSTO™ PRODUCT RANGE

Akusto gives you many ways to individualise your acoustic solution in unique and expressive configurations.

Choose Akusto Wall C Extra Bass to get increased speech clarity due to the extra absorption feature for low frequency sounds.

Screens are ideal for strategic acoustic performance support. Akusto Screen is light and freestanding, so can be re-positioned as needed.

AKUSTO WALL A

2700x1200x40



AKUSTO ONE

- Ø592x40
- Ø792x40
- Ø1192x40
- 592x592x40
- 1192x292x40
- 1192x592x40



AKUSTO WALL C

2700x600x40

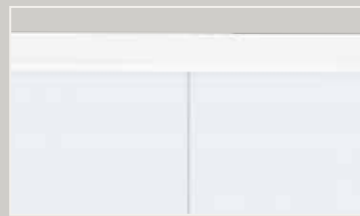

AKUSTO SCREEN

1500x1200x40

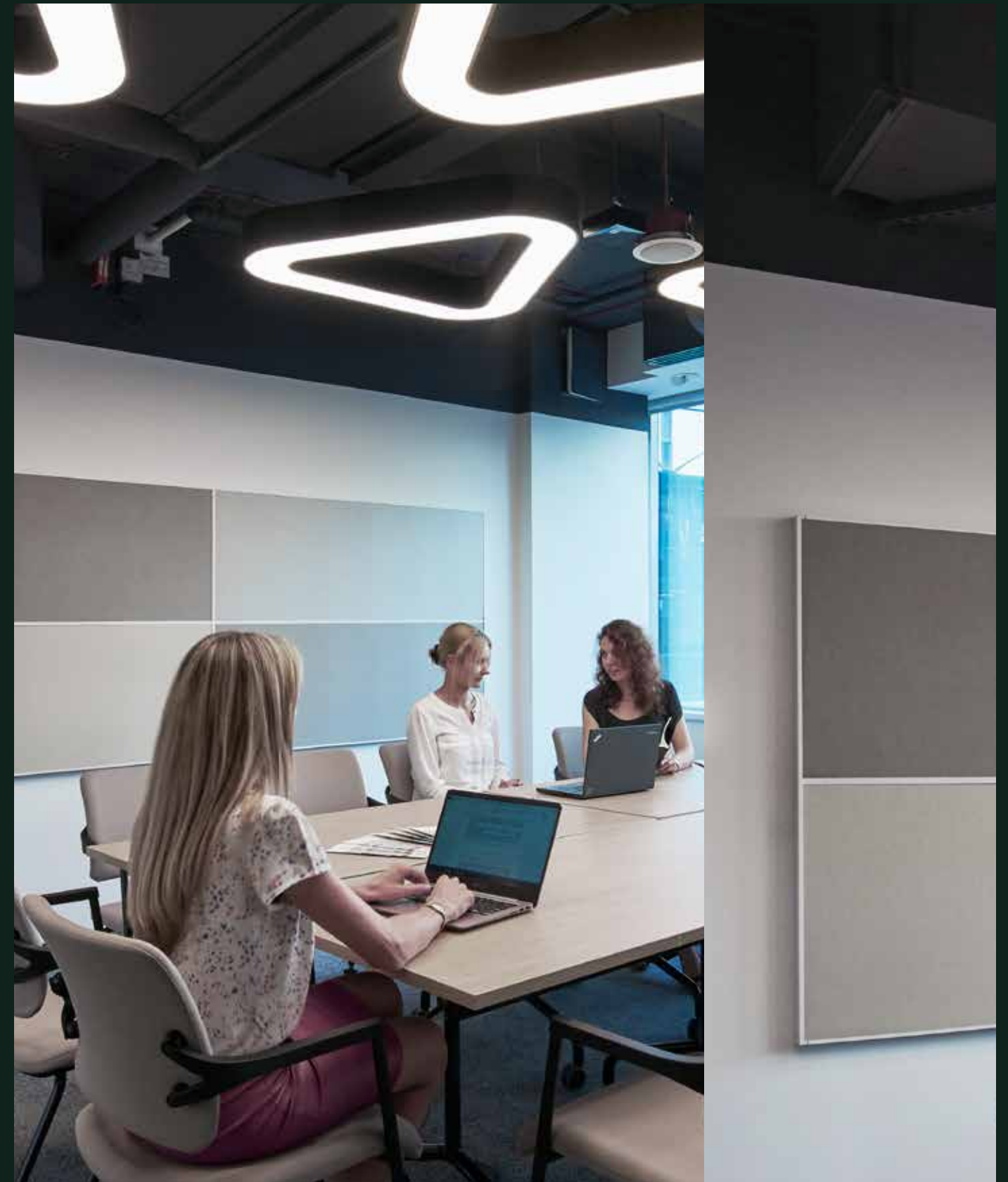

AKUSTO WALL A
Framed wall panels in wide range of colours.

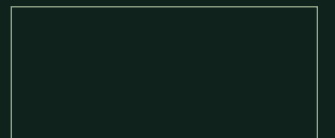

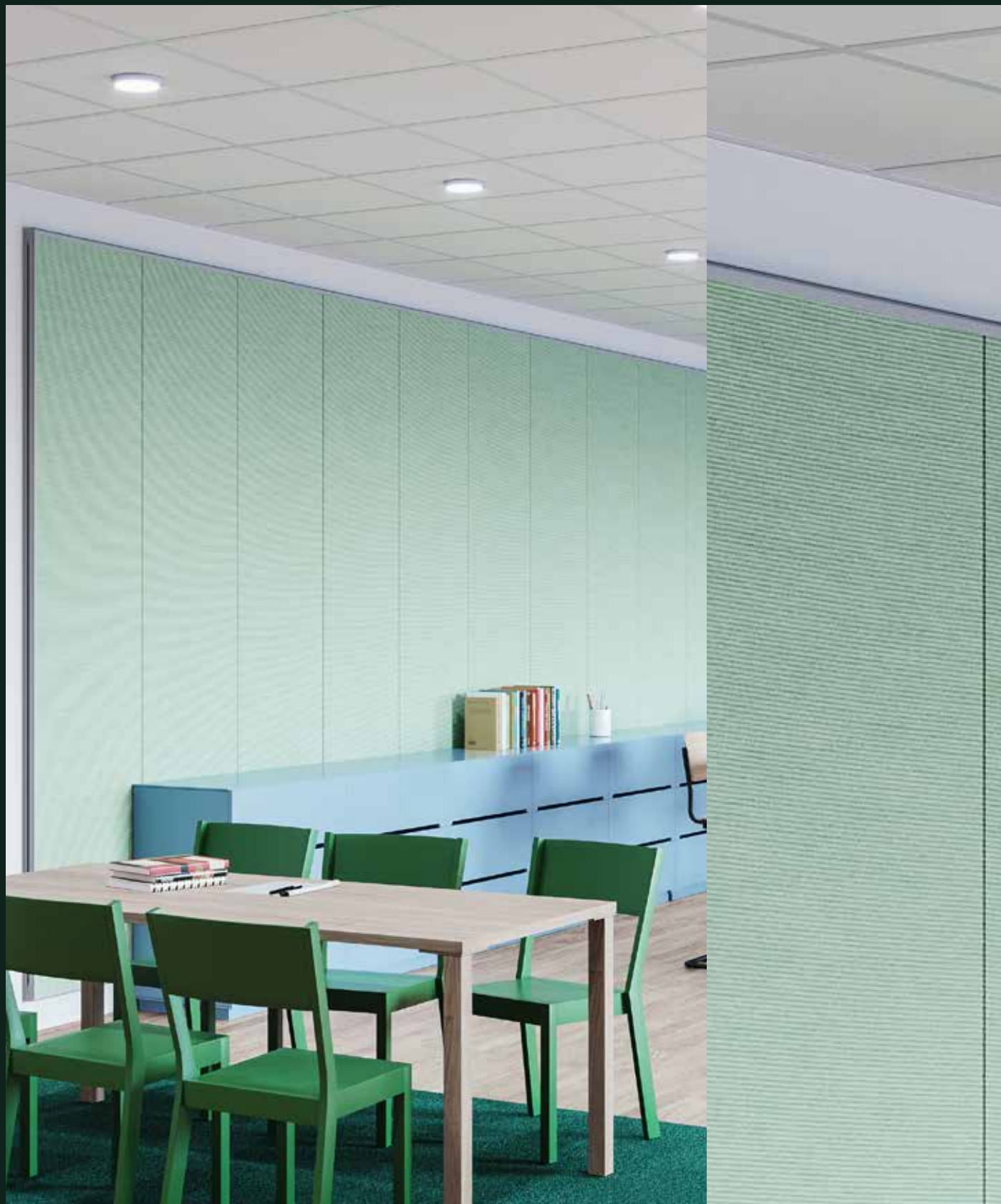

AKUSTO WALL C
Smoothly framed wall panel solutions in wide range of colours.

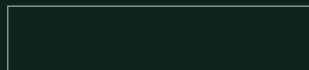

AKUSTO WALL C EXTRA BASS
Shadow framed low frequency wall panel solution in wide range of colours.

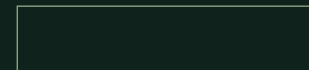



AKUSTO ONE
Easy to install frameless wall panels in many shapes and colours.

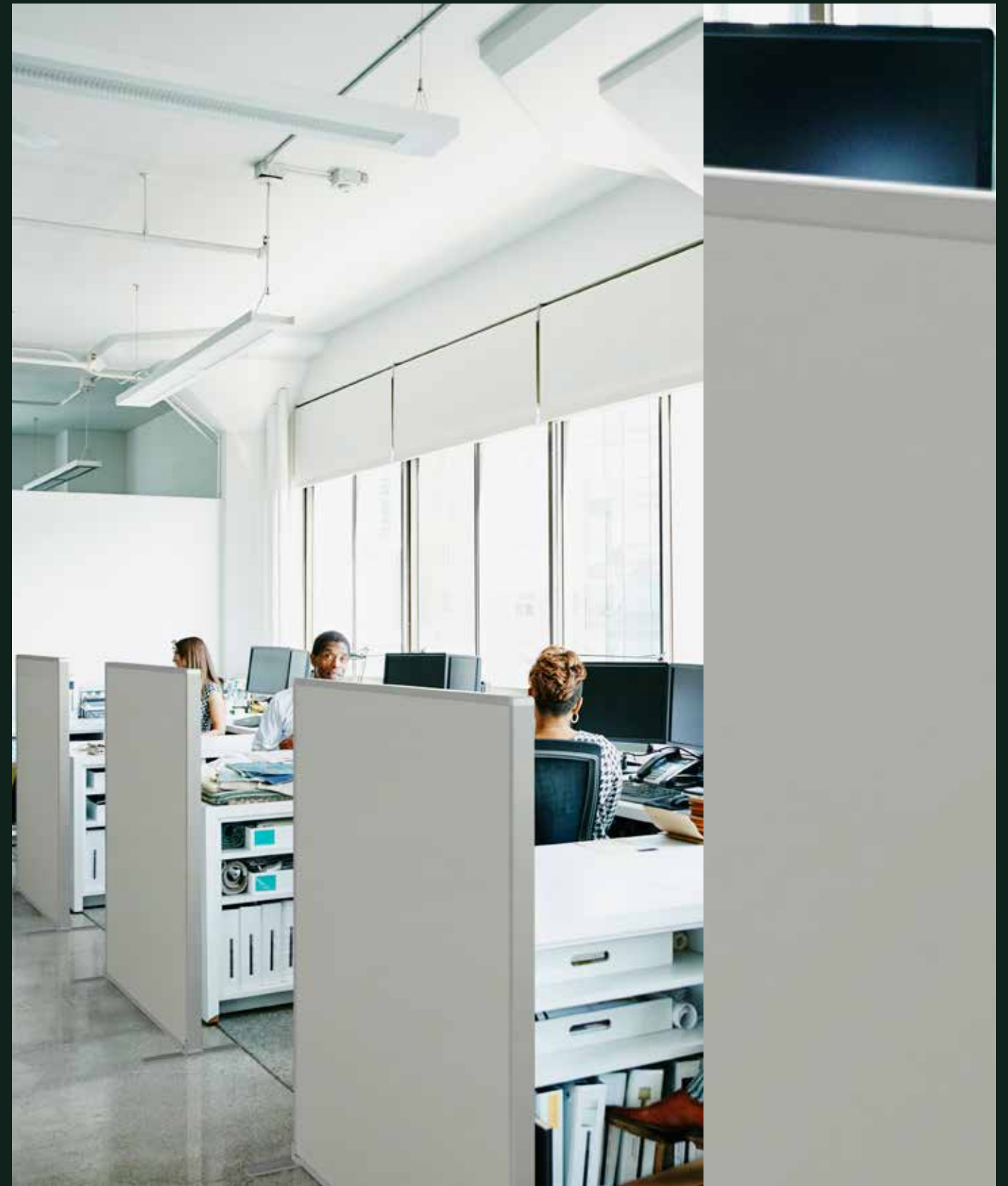

AKUSTO SCREEN
Moveable screens for good sound environment in open plan offices. Available in a wide range of colours.

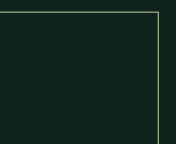

INSTALLATION METHODS

The innovative Connect™ accessories enable the wall absorbers to be mounted with a perfect fit and in many different ways. As Ecophon Akusto is designed for flexible placement, the creative ways to arrange them are almost endless.

ECOPHON E-TOOLS

Ecophon offers several useful tools and services for the different phases of the building process, from inspiration to specific maintenance instructions for your Ecophon products.

Read more and try our E-tools at www.ecophon.com

ECOPHON AKUSTO™ WALL



CONNECT SHADOW PROFILE has a design which creates a shadow effect. The elegant solution gives a light impression and allows you to create fields of colours and patterns both vertically and horizontally.

ECOPHON AKUSTO™ ONE

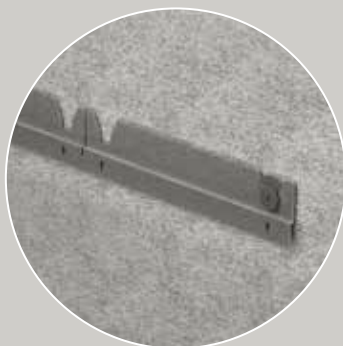

CONNECT ONE TRIM is screwed to the wall and act as a holder for Connect Absorber Anchor One, which is screwed into the back of the panel.



CONNECT ONE FIXING is a holder screwed to the wall. The panel is secured with a specially designed, textured button, available in several colours.



CONNECT ONE HOOK FIXING is a plate with hooks which is screwed to the wall and the panel is pressed onto the hooks.

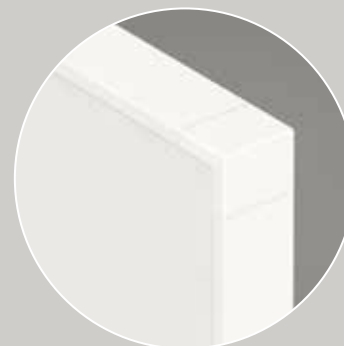

CONNECT THINLINE PROFILE is an elegant solution which allows you to create fields of colours and patterns both vertically and horizontally.





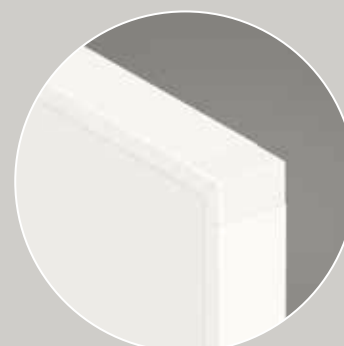



CONNECT WP PROFILE is a robust profile solution that establishes a distinct frame around the wall panel.

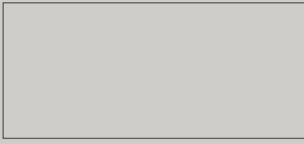
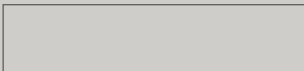
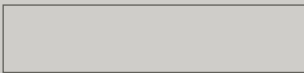

CONNECT CHANNEL TRIM is a simple and functional solution. It can be installed with Connect T24 Main Runners or using Connect Recessed Profile which allows you to add shelves and use it as a bookcase.



ECOPHON AKUSTO OVERVIEW

Shape	Product	Sizes (mm)	Installation methods								Surface	
			Wall with Connect Thinline	Wall with Connect Shadow Profile	Wall with Connect WP	Wall with Connect Channel Trim	Wall with Connect One Trim	Wall with Connect One Hook	Wall with Connect One	Floor standing		
	Ecophon Akusto Wall A	2700x1200x40	•			•						Akutex FT Ecophon Texona Ecophon Super G
	Ecophon Akusto Wall C	2700x600x40	•		•							Akutex FT Ecophon Texona Ecophon Super G
	Akusto Wall C Extra Bass	2700x600x80		•								Akutex FT Ecophon Texona
	Ecophon Akusto One	592x592x40						•	•			Akutex FT Ecophon Texona
		1192x292x40						•	•			
		1192x592x40						•	•			
		Ø592x40 Ø792x40 Ø1192x40						•	•	•		
	Ecophon Akusto Screen	1500x1200x40									•	Ecophon Texona



Ecophon Akusto panels contribute to a healthy indoor environment with superior acoustic absorption, low VOC emissions in line with the strictest requirements, and a full chemical transparency with verified Health Product Declarations. The low environmental footprint of our Akusto panels is third-party verified in Environmental Product Declarations.

The products do not contribute to fire and the glass wool core of the Akusto tiles is tested and classified as non-combustible according to EN ISO 1182. Fire classification according to EN 13501-1, see Technical Properties on respectively product.

NOTE

More product and system information such as installation help and sustainability documentation can be found at www.ecophon.com/exp



COLOURS AND SURFACES

AKUTEX™ FT

The Akutex label guarantees that the product carrying it has a superior surface technology. Our research and development will always focus on visual aspects, acoustic properties, working environment, architectural trends and environmental aspects. This ensures that Akutex is always one step ahead.



WHITE FROST
Nearest NCS colour sample S 0500-N.
Light reflectance 85%.



OCEAN STORM
Nearest NCS colour sample S 4020-R90B.
Light reflectance 24%.



MORNING DRIZZLE
Nearest NCS colour sample S 1002-B.
Light reflectance 69%.



VOLCANIC ASH
Nearest NCS colour sample S 2002-Y.
Light reflectance 56%.



MOONLIGHT SKY
Nearest NCS colour sample S 7020-R90B.
Light reflectance 7%.



CLOUDY DAY
Nearest NCS colour sample S 1500-N.
Light reflectance 62%.



SILVER STONE
Nearest NCS colour sample S 4502-Y.
Light reflectance 29%.



GOLDEN FIELD
Nearest NCS colour sample S 1040-G90Y.
Light reflectance 61%.



PEACH ROSE
Nearest NCS colour sample S 1515-Y80R.
Light reflectance 55%.



SILK SLATE
Nearest NCS colour sample S 7000-N.
Light reflectance 13%.



SUNSET HEAT
Nearest NCS colour sample S 2070-Y60R.
Light reflectance 20%.



HIGHLAND FOG
Nearest NCS colour sample S 2005-G.
Light reflectance 55%.



GOJI BERRY
Nearest NCS colour sample S 3030-Y80R.
Light reflectance 27%.



RUBY ROCK
Nearest NCS colour sample S 4050-R10B.
Light reflectance 7%.



SAGE GARDEN
Nearest NCS colour sample S 3010-B30G.
Light reflectance 40%.



SILENT STEAM
Nearest NCS colour sample S 2010-B.
Light reflectance 45%.



EUCALYPTUS LEAF
Nearest NCS colour sample S 5010-B30G.
Light reflectance 23%.



FRESH CLOVER
Nearest NCS colour sample S 3020-G40Y.
Light reflectance 35%.



SCALLOP SHELLS
Nearest NCS colour sample S 0804-Y50R.
Light reflectance 76%.



SUMMER FOREST
Nearest NCS colour sample S 6030-G10Y.
Light reflectance 10%.



WET SAND
Nearest NCS colour sample S 3020-Y30R.
Light reflectance 35%.



DARK DIAMOND
Nearest NCS colour sample S 9000-N.
Light reflectance 4%.

NOTE
Colours vary slightly between different production batches.
Reproduction of colours vary between print and reality.

ECOPHON TEXONA

If you want to create expressive sound absorbing wall solutions with a wide range of colours, Texona is the perfect choice. Texona has a smooth textured surface, is impact resistant and available in a variety of colours that allude to flavours.



SEA SALT
Nearest NCS colour sample S 0500-N.
Light reflectance 81%.



SAGE
Nearest NCS colour sample S 3010-B30G.
Light reflectance 41%.



PEPPER
Nearest NCS colour sample S 6502-Y.
Light reflectance 17%.



POPPY SEED
Nearest NCS colour sample S 3020-B10G.
Light reflectance 28%.



GARLIC
Nearest NCS colour sample S 2502-Y.
Light reflectance 52%.



EUCALYPTUS
Nearest NCS colour sample S 5010-B30G.
Light reflectance 23%.



GINGER
Nearest NCS colour sample S 2005-Y30R.
Light reflectance 56%.



ACAI
Nearest NCS colour sample S 6020-R90B.
Light reflectance 12%.



OYSTER
Nearest NCS colour sample S 4005-Y20R.
Light reflectance 32%.



PEACH
Nearest NCS colour sample S 1515-Y80R.
Light reflectance 52%.



SCALLOP
Nearest NCS colour sample S 1005-Y40R.
Light reflectance 67%.



GOJI
Nearest NCS colour sample S 3030-Y80R.
Light reflectance 24%.



THYME
Nearest NCS colour sample S 2010-B90G.
Light reflectance 47%.



LIQUORICE
Nearest NCS colour sample S 9000-N.
Light reflectance 5%.

ECOPHON SUPER G

The Super G surface has been designed for environments where mechanical impact occurs. Super G is a glass fibre fabric with high impact resistance.



WHITE 085
Nearest NCS colour sample S 1002-Y.
Light reflectance 78%.

NOTE
Colours vary between different production batches.
Reproduction of colours vary between print and reality.

COLOURS AND SURFACES

CONNECT THINLINE PROFILE



WHITE 02
Textured, S 1002-Y.

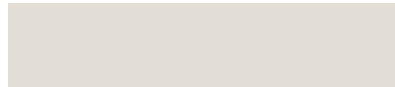

GREY 03
Textured, S 1500-N.



GREY 04
Textured, S 4500-N.



BLACK 01
Textured, S 9000-N.

CONNECT SHADOW PROFILE



GREY 03
Textured, S 1500-N.

CONNECT WP PROFILE



WHITE 03
Textured, S 0502-Y.



NATURAL ANODIZED
Textured, S 1000-N.



BLACK 01
Textured, S 9000-N.

CONNECT CHANNEL TRIM

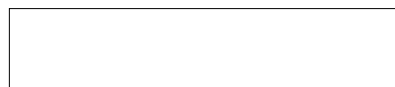

WHITE 02
S 0500-Y.



GREY 01
Metallic, S 2502-B.



BLACK 01
Textured, S 9000-N.

NOTE

Colours may vary slightly between different production batches.

Reproduction of colours vary between print and reality.

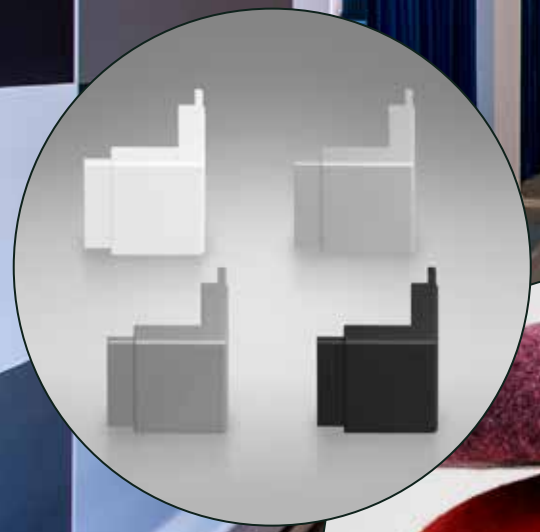



System properties

ACOUSTICS, TECHNICAL PROPERTIES AND INSTALLATION DIAGRAMS

- 28 Akusto Wall A
- 31 Akusto Wall C
- 33 Akusto Wall C Extra Bass
- 36 Akusto One
- 38 Akusto Screen

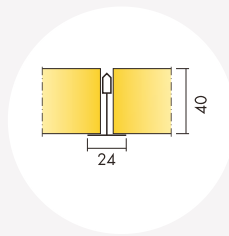

Ecophon Akusto™ Wall A

Acoustic:

Sound Absorption:

Test results according to EN ISO 354. Classification according to EN ISO 11654, and the single value ratings for Noise Reduction Coefficient, NRC and Sound Absorption Average, SAA according to ASTM C 423.

α_p , Practical sound absorption coefficient

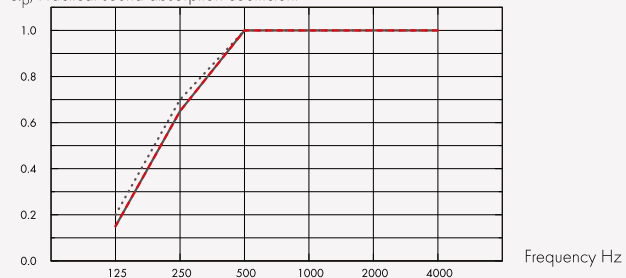

..... Akusto Wall A Akutex FT 40 mm, 43 mm o.d.s.

— Akusto Wall A Texona 40 mm, 43 mm o.d.s.

--- Akusto Wall A Super G 40 mm, 43 mm o.d.s.

o.d.s = overall depth of system

	THK mm	o.d.s. mm	α_p , Practical sound absorption coefficient						α_w	Sound absorption class
			125 Hz	250 Hz	500 Hz	1000 Hz	2000 Hz	4000 Hz		
Akutex FT	40	43	0.20	0.70	1.00	1.00	1.00	1.00	1.00	A
Texona	40	43	0.15	0.65	1.00	1.00	1.00	1.00	1.00	A
Super G	40	43	0.15	0.65	1.00	1.00	1.00	1.00	0.95	A

THK mm	AC(1.5)
40	230
Articulation Class, ASTM E1111, ASTM E1110	

Indoor Air Quality:

Certificate / Label	Standard
Eurofins Indoor Air Comfort®	IAC
French VOC	A
Finnish M1	•

Environmental Footprint: Kg CO₂ equiv/m²: 6,2 From EPD in conformity with ISO 14025 / EN 15804

Circularity: Minimum post-consumer recycled content: 53%, Recyclability: Fully recyclable,

Fire safety: The glass wool core of the tiles is tested and classified as non-combustible according to EN ISO 1182. Europe: EN 13501-1, A2-s1,d0,

Humidity Resistance: Class C, relative humidity 95% and 30°C, according to EN 13964:2014

Visual appearance: Akusto in white has high light reflectance. Light reflectance and nearest NCS colour sample for all the different colours: See Ecophon Colours and surfaces.

Cleanability: Daily dusting, vacuum cleaning and weekly wet wiping (Super G and Akutex FT surfaces). Weekly dusting and vacuum cleaning (Texona surface).

Use of disinfectants: Texona Ginger, Sea salt, Thyme, Oyster and Garlic withstand the frequent use of ethanol (70%)-based disinfectants. Dampen a soft polyester microfiber cloth with the solution and wipe the surface in gentle circular movements.

Accessibility: The tiles are not demountable except in selected installation diagrams. See quantity specification for more information.

Installation: Installed according to installation diagrams, installation guides and drawing aid. For information regarding minimum overall depth of system see quantity specification. The systems should not be placed behind goals or similar areas where they frequently will be hit by hard ball shots. In such cases a protective net in front of the system is recommended.

System weight: The weight of the system (including profile system) should be approximately 4 kg/m².

Mechanical properties: No additional live load is allowed.

Impact Resistance: Tested and classified to fulfil the requirements of DIN 18032-3, equivalent to 1A according to EN13964. Texona surface has moderate impact resistance. Please note: Where the panels are subjected to frequent blows and impacts e.g. behind goal mouths, protection in form of e.g. restraining nets or wooden slats is required. Super G: M353, Fulfills,

CE: Ecophon ceiling systems are CE marked according to the European harmonized standard EN 13964:2014. CE marked construction products are covered by a Declaration of Performance (DOP) which enables customers and users to easily compare performance of products available on the European market.

Installation diagram in detail www.ecophon.com

M353

Installation diagram (M353) for Ecophon Akusto Wall A

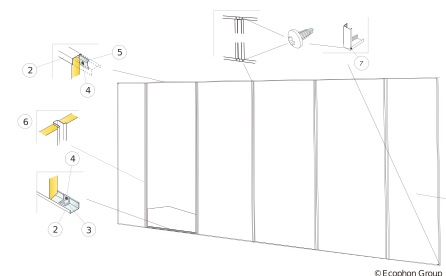

M504

Installation diagram (M504) for Ecophon Akusto Wall A

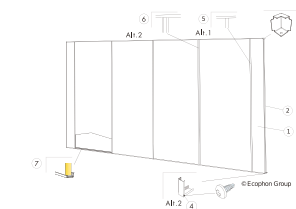

M509
Installation diagram (M509) for Ecophon Akusto Wall A with Connect Thinline profiles.

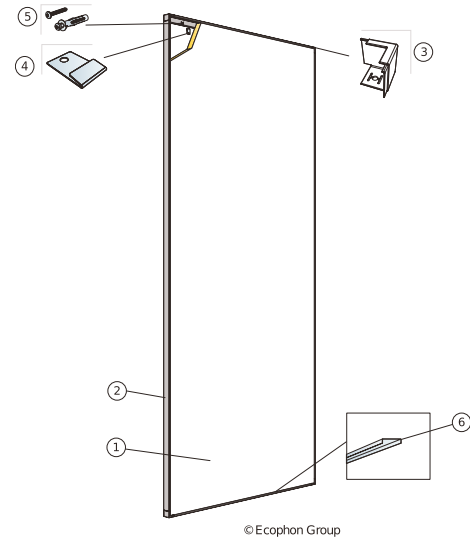

© Ecophon Group

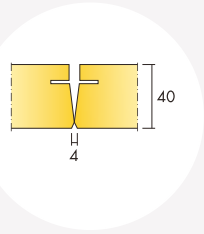

Ecophon Akusto™ Wall C

Acoustic:

Sound Absorption:

Test results according to EN ISO 354. Classification according to EN ISO 11654, and the single value ratings for Noise Reduction Coefficient, NRC and Sound Absorption Average, SAA according to ASTM C 423.

α_p , Practical sound absorption coefficient

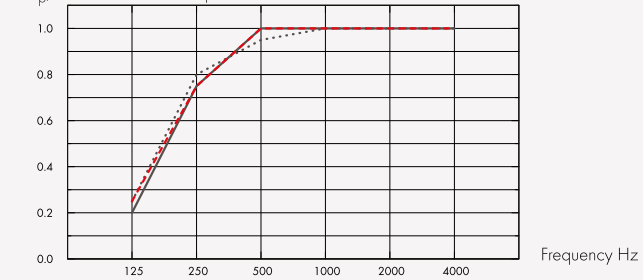

.... Akusto Wall C Akutex FT 40 mm, 43 mm o.d.s.
— Akusto Wall C Texona 40 mm, 43 mm o.d.s.
- - - Akusto Wall C Super G 40 mm, 43 mm o.d.s.
o.d.s = overall depth of system

	THK mm	o.d.s. mm	α_p , Practical sound absorption coefficient					α_w	Sound absorption class
			125 Hz	250 Hz	500 Hz	1000 Hz	2000 Hz		
Akutex FT	40	43	0.25	0.80	0.95	1.00	1.00	1.00	A
Texona	40	43	0.20	0.75	1.00	1.00	1.00	1.00	A
Super G	40	43	0.25	0.75	1.00	1.00	1.00	1.00	A

THK mm	AC(1.5)
40	Articulation Class, ASTM E1111, ASTM E1110 240

Indoor Air Quality:

Certificate / Label	Standard
Eurofins Indoor Air Comfort®	IAC
French VOC	A
Finnish M1	•

Environmental Footprint: Akusto Wall C - Texona : 7,7 (Akusto Wall C EPD in conformity with ISO 14025 / EN 15804) , Akusto Wall C - Akutex FT : 7,4 (Akusto Wall C EPD in conformity with ISO 14025 / EN 15804) , Akusto Wall C - Super G : 9,0 (Akusto Wall C EPD in conformity with ISO 14025 / EN 15804)

Circularity: Minimum post-consumer recycled content: 60%, Recyclability: Fully recyclable,

Fire safety: The glass wool core of the tiles is tested and classified as non-combustible according to EN ISO 1182. Europe: EN 13501-1, A2-s1,d0,

Humidity Resistance: Class C, relative humidity 95% and 30°C, according to EN 13964:2014

Visual appearance: Akusto in white has high light reflectance. Light reflectance and nearest NCS colour sample for all the different colours: See Ecophon Colours and surfaces.

Cleanability: Daily dusting, vacuum cleaning and weekly wet wiping (Super G and Akutex FT surfaces). Weekly dusting and vacuum cleaning (Texona surface).

Use of disinfectants: Texona Ginger, Sea salt, Thyme, Oyster and Garlic withstand the frequent use of ethanol (70%)-based disinfectants. Dampen a soft polyester microfiber cloth with the solution and wipe the surface in gentle circular movements.

Accessibility: The tiles are not demountable except in selected installation diagrams. See quantity specification for more information.

Installation: Installed according to installation diagrams, installation guides and drawing aid. For information regarding minimum overall depth of system see quantity specification. The systems should not be placed behind goals or similar areas where they frequently will be hit by hard ball shots. In such cases a protective net in front of the system is recommended.

System weight: The weight of the system (including profile system) should be approximately 5 kg/m².

Mechanical properties: No additional live load is allowed.

Impact Resistance: Tested and classified to fulfil the requirements of DIN 18032-3, equivalent to 1A according to EN13964. Super G: M354, Fulfills,

CE: Ecophon ceiling systems are CE marked according to the European harmonized standard EN13964:2014. CE marked construction products are covered by a Declaration of Performance (DOP) which enables customers and users to easily compare performance of products available on the European market.

Installation diagram in detail www.ecophon.com

M355
Installation diagram (M355) for Ecophon Akusto Wall C horizontal installation

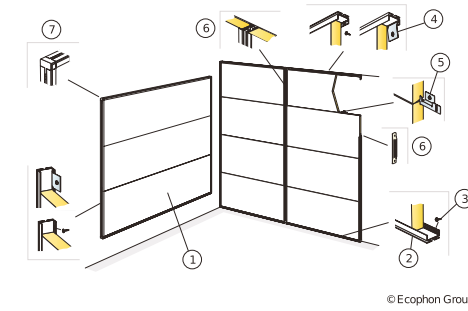

M508
Installation diagram (M508) for Ecophon Akusto Wall C horizontal installation

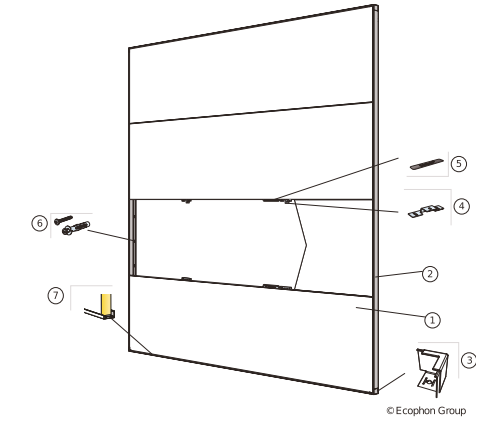

M497
Installation diagram (M497) for Ecophon Akusto Wall C vertical installation with Connect Thinline profiles.

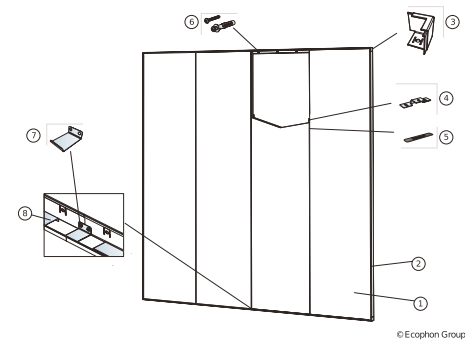

M354
Installation diagram (M354) for Ecophon Akusto Wall C vertical installation

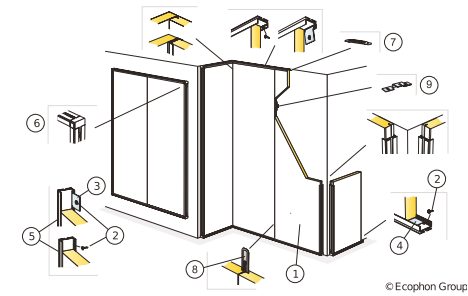

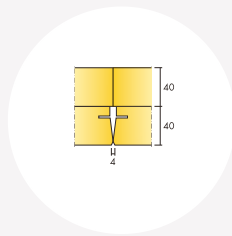

Ecophon Akusto™ Wall C Extra Bass

Acoustic:

Sound Absorption:

Test results according to EN ISO 354. Classification according to EN ISO 11654, and the single value ratings for Noise Reduction Coefficient, NRC and Sound Absorption Average, SAA according to ASTM C 423.

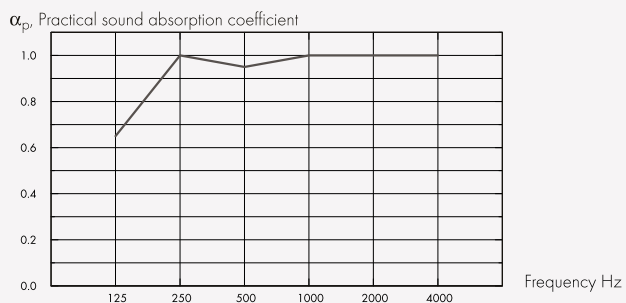

— Akusto Wall C Extra Bass 80 mm, 80 mm o.d.s.
o.d.s = overall depth of system

	THK mm	o.d.s. mm	alpha_p, Practical sound absorption coefficient					alpha_w	Sound absorption class
			125 Hz	250 Hz	500 Hz	1000 Hz	2000 Hz		
Extra Bass	80	80	0.65	1.00	0.95	1.00	1.00	1.00	A

	THK mm	o.d.s. mm	NRC	SAA
Extra Bass	80	80	1.00	1.00

Indoor Air Quality:

Certificate / Label	
Eurofins Indoor Air Comfort®	IAC
French VOC	A
Finnish M1	•

Environmental Footprint: Akusto Wall C Extra Bass/Texona: 10,8 (Akusto Wall C Extra Bass EPD in conformity with ISO 14025 / EN 15804) , Akusto Wall C Extra Bass/Akutex FT: 10,4 (Akusto Wall C Extra Bass EPD in conformity with ISO 14025 / EN 15804),

Circularity: Minimum post-consumer recycled content: 60%, Recyclability: Fully recyclable,

Fire safety: The glass wool core of the tiles is tested and classified as non-combustible according to EN ISO 1182. Europe: EN 13501-1, A2-s1,d0,

Humidity Resistance: Class C, relative humidity 95% and 30°C, according to EN 13964:2014

Visual appearance: Akusto in white has high light reflectance. Light reflectance and nearest NCS colour sample for all the different colours: See Ecophon Colours and surfaces.

Cleanability: Daily dusting, vacuum cleaning and weekly wet wiping (Akutex FT surfaces). Weekly dusting and vacuum cleaning (Texona surface).

Accessibility: The tiles are not demountable.

Installation: Installed according to installation diagrams, installation guides and drawing aid.

System weight: The weight of the system depends on the dimensions of the installation. 2700 x 2700 mm installations has a system weight of approximately 7 kg/m² (including profile system).

Mechanical properties: No additional live load is allowed.

CE: Ecophon ceiling systems are CE marked according to the European harmonized standard EN13964:2014. CE marked construction products are covered by a Declaration of Performance (DOP) which enables customers and users to easily compare performance of products available on the European market.

Installation diagram in detail www.ecophon.com

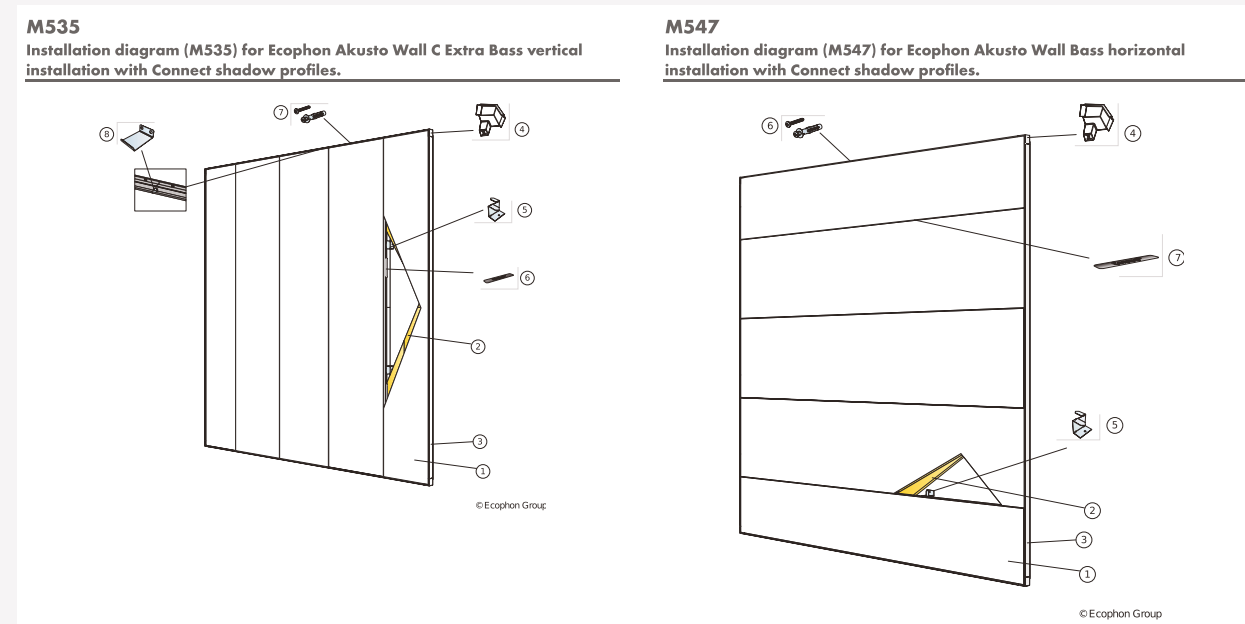

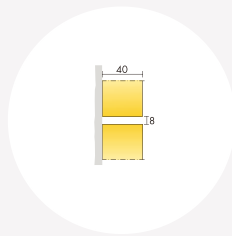

Ecophon Akusto™ One

Acoustic: The values in the diagram refer to a single unit. If the units are arranged in a cluster with distances between units less than 0,5 meters, the Aeq per unit will be slightly reduced.

Sound Absorption:

Test results according to EN ISO 354.

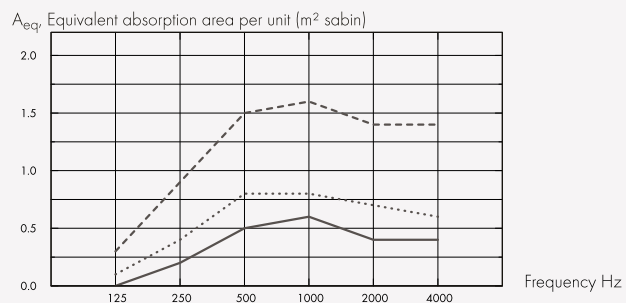

- Akusto One Ø592, 48 mm o.d.s.
 - Akusto One Ø792, 48 mm o.d.s.
 - Akusto One Ø1192, 48 mm o.d.s.
- o.d.s = overall depth of system

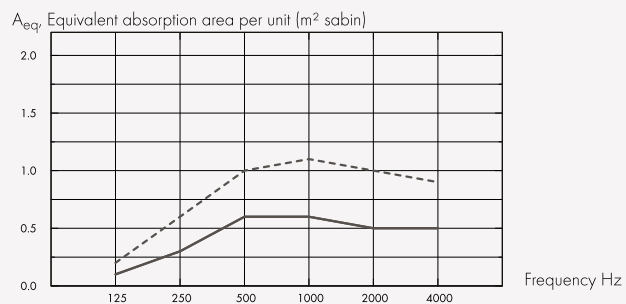

- Akusto One 592x592, 48 mm o.d.s.
 - Akusto One 1192x292, 48 mm o.d.s.
 - Akusto One 1192x592, 48 mm o.d.s.
- o.d.s = overall depth of system

	THK mm	o.d.s. mm	A _{eq} Equivalent absorption area per unit (m ² sabin)					
			125 Hz	250 Hz	500 Hz	1000 Hz	2000 Hz	4000 Hz
Ø592	40	48	0.0	0.2	0.5	0.6	0.4	0.4
Ø792	40	48	0.1	0.4	0.8	0.8	0.7	0.6
Ø1192	40	48	0.3	0.9	1.5	1.6	1.4	1.4
592x592	40	48	0.1	0.3	0.6	0.6	0.5	0.5
1192x292	40	48	0.1	0.3	0.6	0.6	0.5	0.5
1192x592	40	48	0.2	0.6	1.0	1.1	1.0	0.9

Indoor Air Quality:

Certificate / Label

Eurofins Indoor Air Comfort®	IAC
French VOC	A
Finnish M1	•

Environmental Footprint: Akusto One - Akutex FT : 7,35 (Ecophon Akusto family EPD in conformity with ISO 14025 / EN 15804) , Akusto One - Texona : 9,42 (Ecophon Akusto family EPD in conformity with ISO 14025 / EN 15804) ,

Circularity: Minimum post-consumer recycled content: 61%, Recyclability: Fully recyclable,

Fire safety: The glass wool core of the tiles is tested and classified as non-combustible according to EN ISO 1182. Europe: EN 13501-1, A2-s1,d0,

Humidity Resistance: Class C, relative humidity 95% and 30°C, according to EN 13964:2014

Visual appearance: Akusto in white has high light reflectance. Light reflectance and nearest NCS colour sample for all the different colours: See Ecophon Colours and surfaces.

Cleanability: Daily dusting, vacuum cleaning and weekly wet wiping (Akutex FT surfaces). Weekly dusting and vacuum cleaning (Texona surface).

Accessibility: The tiles are easily demountable.

Installation: Installed according to installation diagrams, installation guides and drawing aid. For information regarding minimum overall depth of system see quantity specification.

System weight: The weight of the system (depending on size and including profile system) should be approximately 2,0 - 4,5 kg.

Mechanical properties: No additional live load is allowed.

CE: Ecophon ceiling systems are CE marked according to the European harmonized standard EN13964:2014. CE marked construction products are covered by a Declaration of Performance (DOP) which enables customers and users to easily compare performance of products available on the European market.

Installation diagram in detail www.ecophon.com

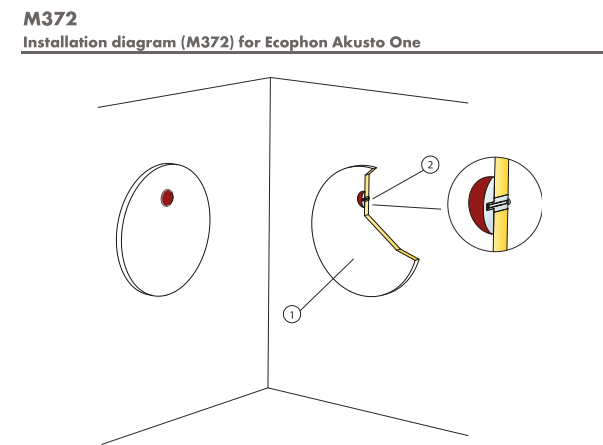
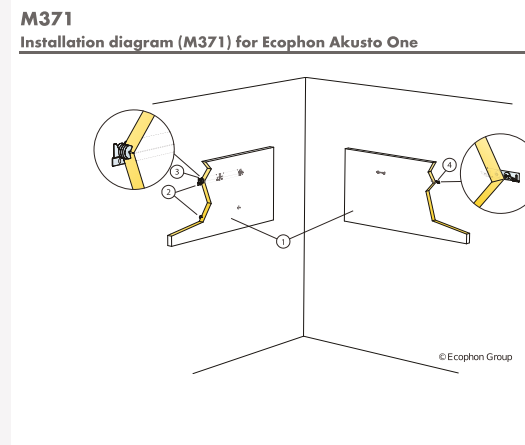

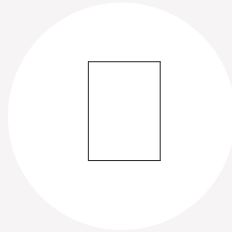

Ecophon Akusto™ Screen

Acoustic:

Sound Absorption:

Sound absorption and sound attenuation test results according to ISO 20189.

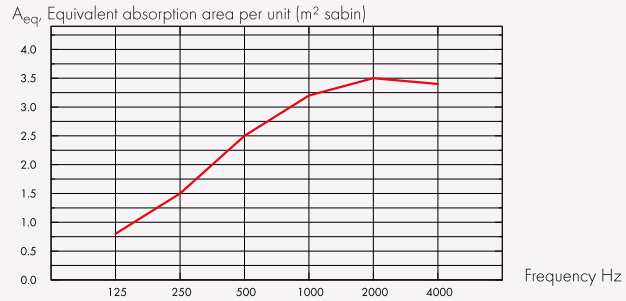

— Akusto Screen, size 1500x1200 mm
o.d.s = overall depth of system

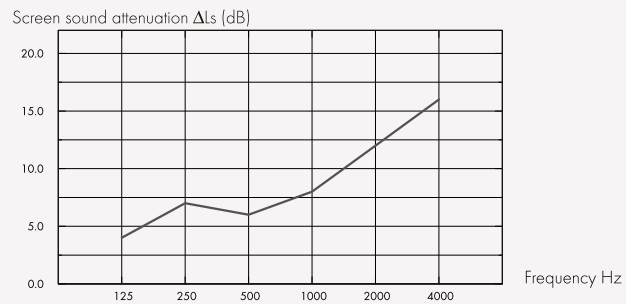

— Akusto Screen, size 1500x1200 mm.
o.d.s = overall depth of system

Size	THK mm	A _{eq} Equivalent absorption area per unit (m² sabin)					
		125 Hz	250 Hz	500 Hz	1000 Hz	2000 Hz	4000 Hz
1500x1200	40	0.8	1.5	2.5	3.2	3.5	3.4

Size	THK mm	Screen sound attenuation ΔLs (dB)						Weighted screen sound attenuation (dB)
		125 Hz	250 Hz	500 Hz	1000 Hz	2000 Hz	4000 Hz	
1500x1200	40	4.0	7.0	6.0	8.0	12.0	16.0	10.0

Indoor Air Quality:

Certificate / Label

French VOC, A

Humidity Resistance: Class A, relative humidity 70% and 25°C, according to EN 13964:2014

Circularity: Fully recyclable.

Visual appearance: Texona in white and Caretec has high light reflectance. For more information regarding visual appearance of the various surfaces: See Ecophon Colours and surfaces.

Cleanability: Weekly dusting and vacuum cleaning. The Caretec surface also withstands weekly wet wiping.

Use of disinfectants: The Caretec surface and Texona Ginger, Sea salt, Thyme, Oyster and Garlic withstand the frequent use of ethanol (70%)-based disinfectants. Additionally, Caretec withstands Klorilli (chloramine 0,1 %). Dampen a soft polyester microfiber cloth with the solution and wipe the surface in gentle circular movements.

Installation: Installed according to the installation guide that is delivered with the product.

Mechanical properties: The product is tested according to EN14073-2 and EN1023.

Installation diagram in detail www.ecophon.com

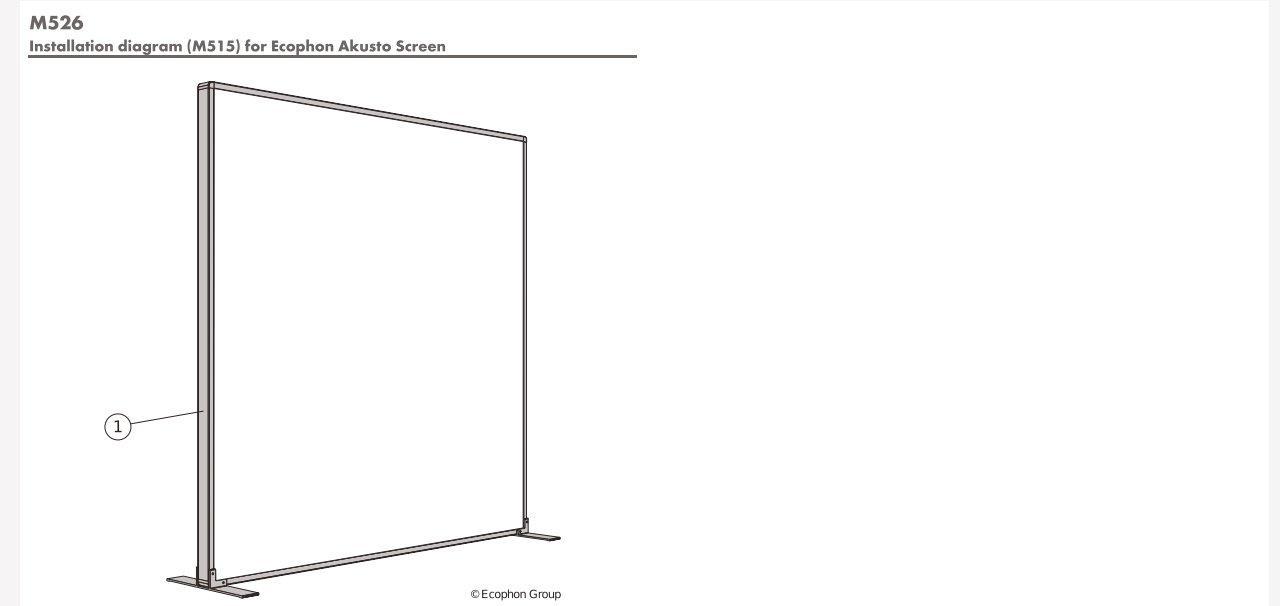

Ecophon is the leading supplier of indoor acoustic solutions that improve working performance and quality of life. We believe in the difference sound can make to our everyday lives, and are passionate advocates for the importance of room acoustics to people's wellbeing – whatever the space, activity or need.

Having a sound effect on people is the principle that guides all we do. We're proud of the Swedish heritage and human approach that promise is founded on. Our uncompromising commitment to transparent sustainable practice. And, as members of the Saint-Gobain Group, to be doing our part in making the world a better home.

