

IT STARTS WITH
FABRIC

Ecophon
SAINT-GOBAIN

CLIPSO®

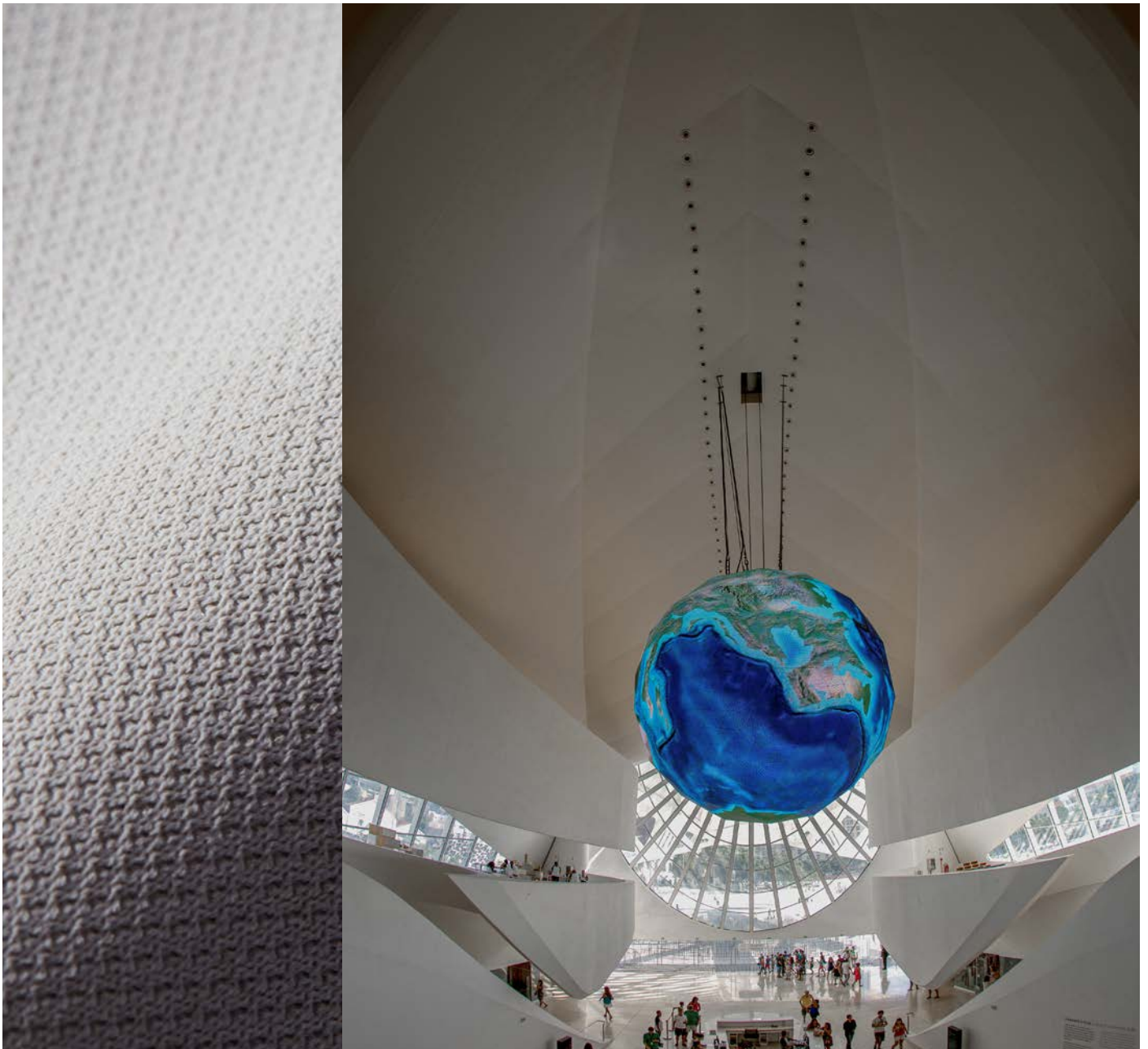

SAINT-GOBAIN

Contents

04 ABOUT ECOPHON

06 GOOD ACOUSTICS MATTER EVERYWHERE

08 IT STARTS WITH FABRICS

10 WHY CLIPSO

12 CLIPSO PRODUCT RANGE

14 MEET OUR PRODUCTS

Clipso So Acoustic

Clipso So Classic

16 INSTALLATION

18 REFERENCES

28 COLOURS AND SURFACES

30 SYSTEM PROPERTIES

This publication shows products from Ecophon product range and those of other suppliers. The specifications are intended to provide a general guide to which products are most suitable for the preferences indicated. Technical data is based on results obtained under typical testing conditions or long experience in normal conditions.

The specified functions and properties for products and systems are only valid on condition that instructions, installation diagrams, installation guides, maintenance instructions and other stated conditions and recommendations have been taken into consideration and followed. Deviation from this, such as changing specific components or products, will mean that Ecophon cannot be held responsible for the function, consequences and properties of the products.

All descriptions, illustrations and dimensions contained in this brochure represent general information and shall not form part of any contract. Ecophon reserves the right to change products without prior notice. We disclaim any liability for misprints. For the latest information go to www.ecophon.com or contact your nearest Ecophon representative.





A sound effect

ON PEOPLE

Saint-Gobain Ecophon contributes to good indoor environments for working, healing and learning. We do this by developing, manufacturing and delivering acoustic products and systems designed around the natural evolution of human hearing – replicating the outdoor sound experience indoors, because that’s just better for people.

Having a sound effect on people, in every way we can, is what we do proudly. That promise makes every one of us a passionate advocate for the importance of room acoustics to people’s wellbeing – whatever the space, activity or need.

Good acoustics

MATTER EVERYWHERE

The importance of acoustics is underappreciated. Sound impacts us in daily life, and the scientific support for improving our indoor sound environments is well-documented.

And what exactly is an ideal indoor sound environment for people? One based on how we experience sound outside. The human auditory sense is naturally adapted to an outdoor environment where there is not any sound reflections from ceilings and walls.

That's why most of what we do at Ecophon is about replicating the acoustic qualities found in nature for indoor environments. We want to optimise indoor spaces to our natural way of hearing, so that speech and sound is easy to hear and understand, when needed, improving performance and wellbeing.

It starts with

FABRIC

Ecophon Clipso™ is a technical knitted fabric, that allows you to dress walls and ceilings with full covering. To create a seamless look, the fabric is stretched by the discrete profile, fixed to the room's perimeter. The visible surface is a knitted textile that is coated to provide a highly resistant fabric.

ABSORPTION

Absorption up to class A

COLORS AND PRINTS

Available in 15 colours, customised prints and four different widths

FABRIC

Coated premium technical fabric

Emiri Terminal Airport, Qatar



Why Clipso



WIDE COVERS UP TO 5.1M

Whole walls can be covered using just one holder. Looking to cover a larger surface? No problem – just use double-joint installation. Create a stretch ceiling with two covers, without any visible connection.

COLD AND DRY INSTALLATION



Clipso fabric is stretched without heating. Installation is quick and clean. This system reduces dust, odours, disruption and energy consumption, while also reducing rearrangement issues, making life easier.



INNOVATIVE ABS, ALU AND PVC PROFILES

With our Clipso profiles, your ceiling will be compatible with a range of different shapes combinations. Clipso profiles are easy to install and cut. They look light and discreet after the installation is finished.

A PERFECT FINISH FOR IMPECCABLE RESULTS



Clipso profiles are designed to be discreet and create a seamless look. Our system will provide you with high-quality walls and stretch ceilings.

IBC Innovation Factory, Denmark





Clipso

PRODUCT RANGE

Clipso offers a wide choice of premium fabrics. They are infinitely customisable, offering the freedom to be unique and transform walls and ceilings into works of art.

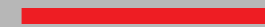

COLOR ON DEMAND

Clipso can give you the colour of your choice. Choose your Pantone colour reference. Choose between standard or acoustic fabric.

WALLS HANGING UNITS AND PARTITIONS

Combine technology and design with lightweight, robust and durable aluminum shapes and structures.

Beautiful aerial forms can be created, such as hanging frames, acoustic baffles, wall frames, paintings and more.

PRINTED SOLUTION

We can print the visuals of your choice. Our image gallery and collection guarantees you'll get spectacular results.

Meet our

PRODUCTS

SO ACOUSTIC – FABRIC AND ACOUSTICS IN ONE

The So Acoustic covering is a major technical achievement that combines acoustic performance with a stretched fabric.

So Acoustic 495 D/AC is an open structure knitted textile fabric with a uniform coating. So Acoustic 495 D/AC is used for rooms that need acoustic improvement. It has a wide range of applications and is suitable for both residential and non-residential areas.

- Absorption up to class A, installed with a 10, 30 or 50 mm absorber
- Up to 5.10 m width
- Cold and dry installation



Corée Du Sud, Korea

SO CLASSIC – FOR THE AESTHETIC AND THE TEXTURE

The So Classic covering works beautifully with any interior and is quick and easy to install. A timeless essential with neutral elegance.

So Classic 705 S is a textile fabric with a uniform coating and a timeless, neutral elegance. So Classic 705 S has a wide range of applications and is suitable for both residential and non-residential areas.

- Light weight fabric installed without absorber
- Up to 5.10 m width
- Cold and dry installation with a neutral finish



Shopping Centre, Spain

Installation

METHODS

STEP 1: positioning the covering

Make fixing points every 500 mm. Take geometry into account and start with the largest surfaces.

STEP 2: stretching the covering

Return to the different points in the order indicated, and always work with opposite corners. Always start at the centre and finish in the corners.

STEP 3: closing off the covering

Clip the covering into the recess in the profile. The mechanics of the profile ensure perfect stretching. The purpose of this essential operation is to eliminate surplus material.

STEP 4: finish

Ensure that step 3 was completed without leaving openings between points. Cut off the surplus material, making sure to leave 10 mm of fabric after the profile. Using a putty knife, press the covering into the profiles. Use a heat gun to remove any minor imperfections.

References



18

19



Museum of Tomorrow, Brazil



Motion Picture Association (MPA), United States



The Blue Lagoon, Iceland

Colours



Globus Max, Israel

Customised

PRINTED FABRICS



© Maxime Ardilouze / Skymakers, Qatar



Origine Office Building, France

Straight

EDGE

- Available on islands, baffles, wall hanging units, totems and partitions
- Aluminum frame available in white, black or anodized aluminum
- Height from 40 mm to 100 mm
- The aluminum edge can be visible or cover by the fabric

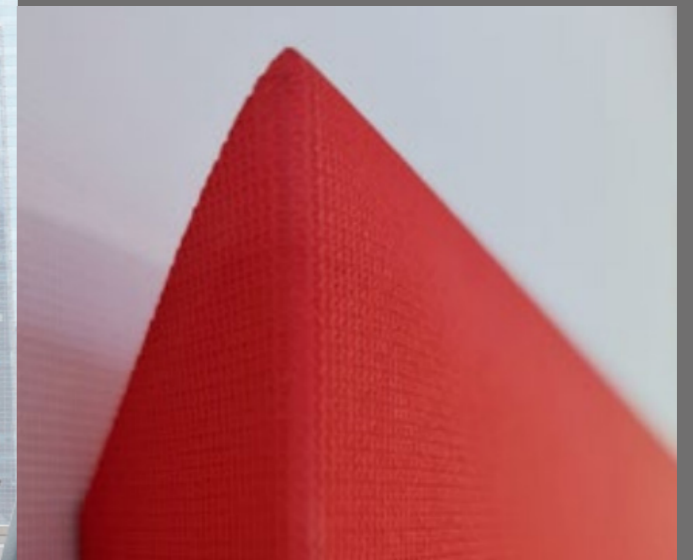
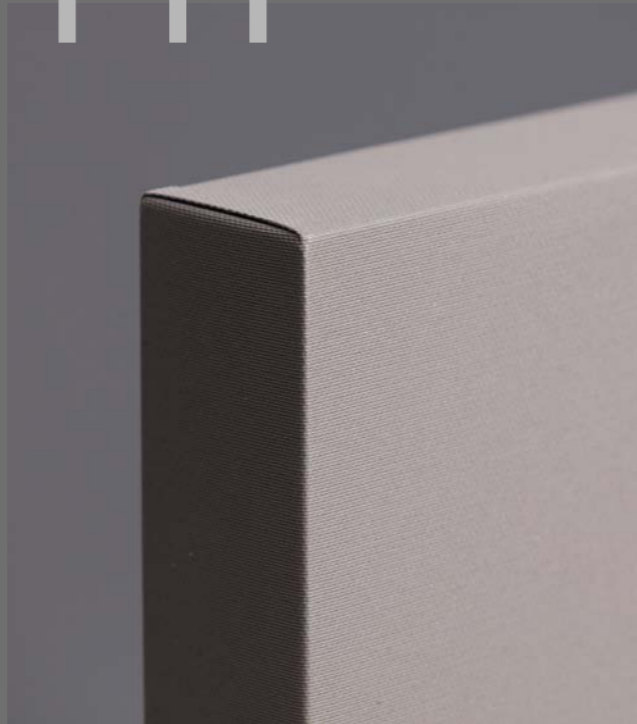

- Available on islands and wall hanging units
- Beveled edges and covers by the fabric
- White, color and print available
- Height: 39 mm
- Fabric with 2 layers of 10mm acoustic absorbent LA10

EDGE - THE ELEGANT DESIGN

Arawn

CLIPSO COLOURS AND SURFACES

Ecophon Clipso™ offers a large choice of premium fabrics. They are infinitely customisable, and offer the freedom to be unique and turn walls and ceilings into works of art.

SO ACOUSTIC – FABRIC AND ACOUSTICS IN ONE (495 AC)

Cire
4004



Craie
4011

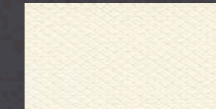

Chair
4012

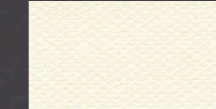

Galet
4025



Ecume
4031



Gris Perle
4032

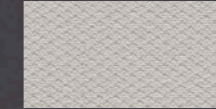

Pierre
4040



Poivre
4041



Ciment
4051



Cendre
4052

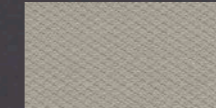

Anthracite
4054



Chataigne
4062

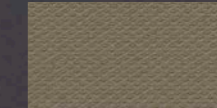

Classical White
0002

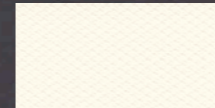

White
0003



Black
9999



SO CLASSIC – FOR THE AESTHETIC AND THE TEXTURE (705 S)

Optic White
0001

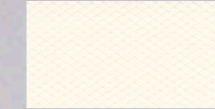

Classical White
0002

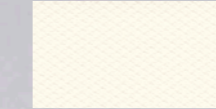

Black
9999



Available in 15 colors,
customised prints, and
different widths

NOTE

Colours may vary slightly between different production batches.

Reproduction of colours vary between print and reality.



System properties

**ACOUSTICS, TECHNICAL PROPERTIES
AND INSTALLATION DIAGRAMS**

- 32 Ecophon Clipso™ So Acoustic
- 34 Ecophon Clipso™ So Classic

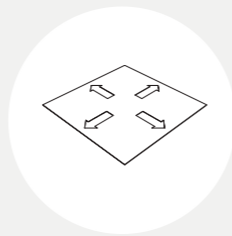

Ecophon Clipso™ So Acoustic

Acoustic:

Sound Absorption:

Test results according to EN ISO 354. Classification according to EN ISO 11654.

α_p , Practical sound absorption coefficient

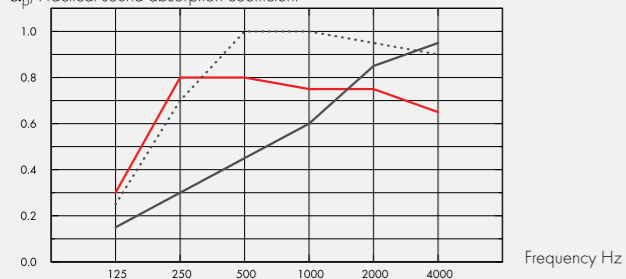

- So Acoustic 495AC GW40, 200 mm o.d.s.
 - So Acoustic 495AC LA50, 55mm o.d.s.
 - So Acoustic 495AC LA10, 10mm o.d.s.
- o.d.s = overall depth of system

α_p , Practical sound absorption coefficient

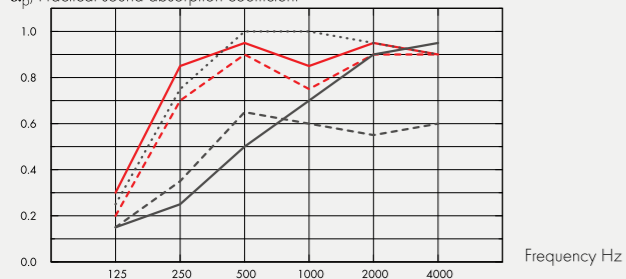

- So Acoustic 495D GW40, 200 mm o.d.s.
 - - - So Acoustic 495D GW20, 200 mm o.d.s.
 - So Acoustic 495D no absorber, 155mm o.d.s.
 - So Acoustic 495D LA50, 55mm o.d.s.
 - So Acoustic 495D LA10, 10mm o.d.s.
- o.d.s = overall depth of system

	THK mm	o.d.s. mm	α_p , Practical sound absorption coefficient						α_w	Sound absorption class
			125 Hz	250 Hz	500 Hz	1000 Hz	2000 Hz	4000 Hz		
495AC GW40	40	200	0.30	0.80	0.80	0.75	0.75	0.65	0.75	C
495AC LA50	50	55	0.25	0.70	1.00	1.00	0.95	0.90	0.95	A
495AC LA10	10	10	0.15	0.30	0.45	0.60	0.85	0.95	0.50	D
495D GW40	40	200	0.30	0.85	0.95	0.85	0.95	0.90	0.95	A
495D GW20	20	200	0.20	0.70	0.90	0.75	0.90	0.90	0.85	B
495D	0	155	0.15	0.35	0.65	0.60	0.55	0.60	0.60	C
495D LA50	50	55	0.25	0.75	1.00	1.00	0.95	0.90	1.00	A
495D LA10	10	10	0.15	0.25	0.50	0.70	0.90	0.95	0.50	D

Indoor Air Quality:

Certificate / Label

Eurofins Indoor Air Comfort®	IAC Gold
French VOC	A+
Greenguard	Gold

Fire safety: Europe: EN 13501-1, B-s1,d0, International Maritime Organisation: Resolutions MSC.307(88) and MSC.61(67), Modules B and D (495D),

Humidity Resistance: Dimensional stability under the action of humidity: EN 14716 (appendix C), 0% (MD), 0% (CMD) (495D), Dimensional stability under the action of heat: EN 12280-1 (30 min, 60°C), 0% (MD), 0% (CMD) (495D, 495AC), Water vapour transmission rate: ISO 2528 (38°C, 90% RH), 1901 g/m² (495D) 2104 g/m² (495AC),

Visual appearance: Matt, smooth and uniform. 495D White, nearest colour sample RAL 9016.

Cleanability: Use of Clipso Cleaning Kit recommended. Alternatively, other pH-neutral cleaning agents can be used with a soft cloth, provided it has first been tested on a scrap piece or on a non-visible area of the fabric.

Mould and Bacterial Resistance: ISO 846 A: 0, ISO 846 C: 0,

Accessibility: The system supports installation of inspection hatches.

Installation: Installed with Clipso profiles according to installation diagrams and drawing aid.

System weight: 495D: Area weight 230 g/m² ± 10% (ISO 2286-2). 495AC: Area weight 250 g/m² ± 10% (ISO 2286-2).

Mechanical properties: Additional load (lighting, ventilation, etc.) should be hung directly from the soffit. Tensile strength: ISO 1421, 30 daN/5 cm (MD), 54 daN/5 cm (CMD) (495D) 29 daN/5 cm (MD), 107 daN/5 cm (CMD) (495AC), Tear strength: EN 1875-3, 8.9 daN (MD), 15.9 daN (CMD) (495D) 10.8 daN (MD), 17.7 daN (CMD) (495AC),

CE: Clipso technical fabrics are CE-marked according to the European harmonized standard EN14716:2005. CE marked construction products are covered by a Declaration of Performance (DOP) which enables customers and users to easily compare performance of products available on the European market.

Installation diagram in detail www.ecophon.com

M565

Installation diagram (M571) for Clipso SO Acoustic with acoustic absorbers, ceiling application with PCW profiles

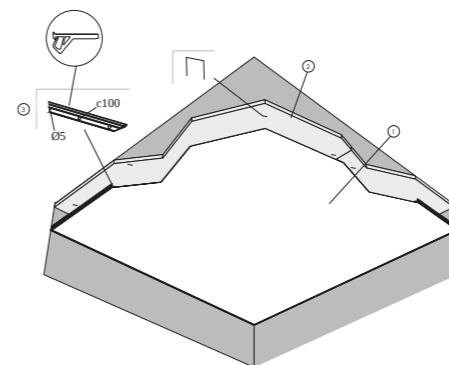

M566

Installation diagram (M566) for Clipso SO Acoustic, wall application with PCC profiles

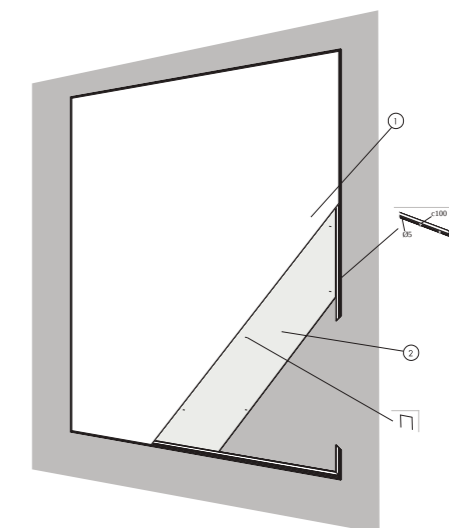

M571

Installation diagram (M571) for Clipso SO Acoustic, ceiling application with PCC profiles

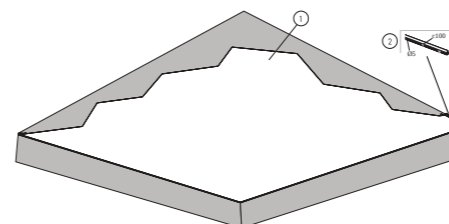

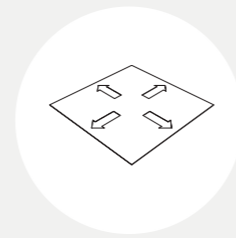

Ecophon Clipso™ So Classic

Indoor Air Quality:

Certificate / Label

Eurofins Indoor Air Comfort®	IAC Gold
French VOC	A+
Greenguard	Gold

Fire safety: Europe: EN 13501-1, B-s1,d0, International Maritime Organisation: Resolutions MSC.307(88) and MSC.61(67), Modules B and D,

Humidity Resistance: Dimensional stability under the action of humidity: EN 14716 (appendix C), 0% (MD), 0% (CMD), Dimensional stability under the action of heat: EN 12280-1 (30 min, 60°C), 0% (MD), 0% (CMD), Water vapour transmission rate: ISO 2528 (38°C, 90% RH), 1184 g/m²,

Visual appearance: Matt, smooth and uniform. Optical white, nearest colour sample RAL 9016.

Cleanability: Use of Clipso Cleaning Kit recommended. Alternatively, other pH-neutral cleaning agents can be used with a soft cloth, provided it has first been tested on a scrap piece or on a non-visible area of the fabric.

Mould and Bacterial Resistance: ISO 846 A: 0, ISO 846 C: 0,

Accessibility: The system supports installation of inspection hatches.

Installation: Installed with Clipso profiles according to installation diagrams and drawing aid.

System weight: The weight of the fabric is approximately 245 g/m².

Mechanical properties: Additional load (lighting, ventilation, etc.) should be hung directly from the soffit. Tensile strength: ISO 1421, 28 daN/5 cm (MD), 62 daN/5 cm (CMD), Tear strength: EN 1875-3, 3.7 daN (MD), 6.0 daN (CMD),

CE: Clipso technical fabrics are CE-marked according to the European harmonized standard EN14716:2005. CE marked construction products are covered by a Declaration of Performance (DOP) which enables customers and users to easily compare performance of products available on the European market.

Installation diagram in detail www.ecophon.com

M569

Installation diagram (M569) for Clipso SO Classic, ceiling application with PCW profiles

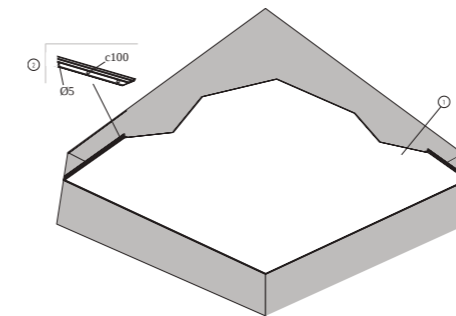

M570

Installation diagram (M570) for Clipso SO Classic, wall application

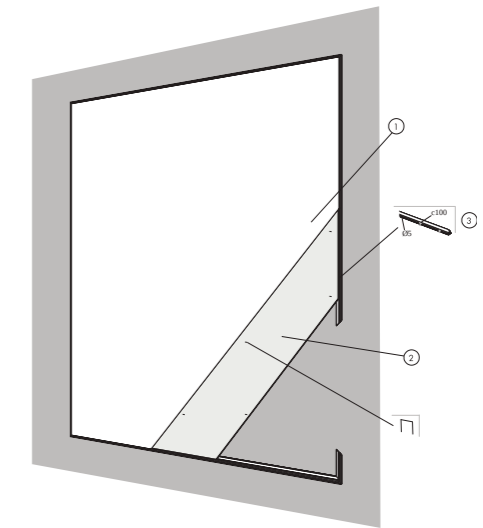

M572

Installation diagram (M572) for Clipso SO Classic, ceiling application with PCC profiles

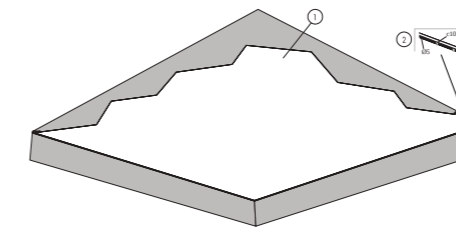

Ecophon is the leading supplier of indoor acoustic solutions that improve working performance and quality of life. We believe in the difference sound can make to our everyday lives, and are passionate advocates for the importance of room acoustics to people's wellbeing – whatever the space, activity or need.

Having a sound effect on people is the principle that guides all we do. We're proud of the Swedish heritage and human approach that promise is founded on. Our uncompromising commitment to transparent sustainable practice. And, as members of the Saint-Gobain Group, to be doing our part in making the world a better home.

