

EXPERIENCING  
FREEDOM OF  
EXPRESSION

# ECOPHON SOLO™



**Ecophon**®  
SAINT-GOBAIN

A SOUND EFFECT ON PEOPLE

# Contents

## 04 ABOUT ECOPHON

## 06 GOOD ACOUSTICS MATTER EVERYWHERE

## 08 SUSTAINABILITY AS A GUIDING LIGHT

## 10 FREEDOM OF EXPRESSION WITH ECOPHON SOLO™

## 12 ECOPHON SOLO PRODUCT RANGE

- 14 Solo Square
- 14 Solo Rectangle
- 15 Solo Rectangle Line
- 15 Solo Circle
- 16 Solo Circle XL
- 16 Solo Freedom
- 17 Solo Textile
- 17 Solo Baffle
- 18 Solo Baffle Wave
- 18 Solo Baffle ZigZag
- 19 Solo Baffle Wall
- 19 Solo Matrix

## 20 INSTALLATION METHODS

## 22 ECOPHON SOLO OVERVIEW

## 24 COLOURS AND SURFACES

## 26 SYSTEM PROPERTIES

Acoustics, technical properties and installation diagrams

This publication shows products from Ecophon product range and those of other suppliers. The specifications are intended to provide a general guide to which products are most suitable for the preferences indicated. Technical data is based on results obtained under typical testing conditions or long experience in normal conditions. The specified functions and properties for products and systems are only valid on condition that instructions, installation diagrams, installation guides, maintenance instructions and other stated conditions and recommendations have been taken into consideration and followed. Deviation from this, such as changing specific components or products, will mean that Ecophon cannot be held responsible for the function, consequences and properties of the products. All descriptions, illustrations and dimensions contained in this brochure represent general information and shall not form part of any contract. Ecophon reserves the right to change products without prior notice. We disclaim any liability for misprints. For the latest information go to [www.ecophon.com](http://www.ecophon.com) or contact your nearest Ecophon representative.





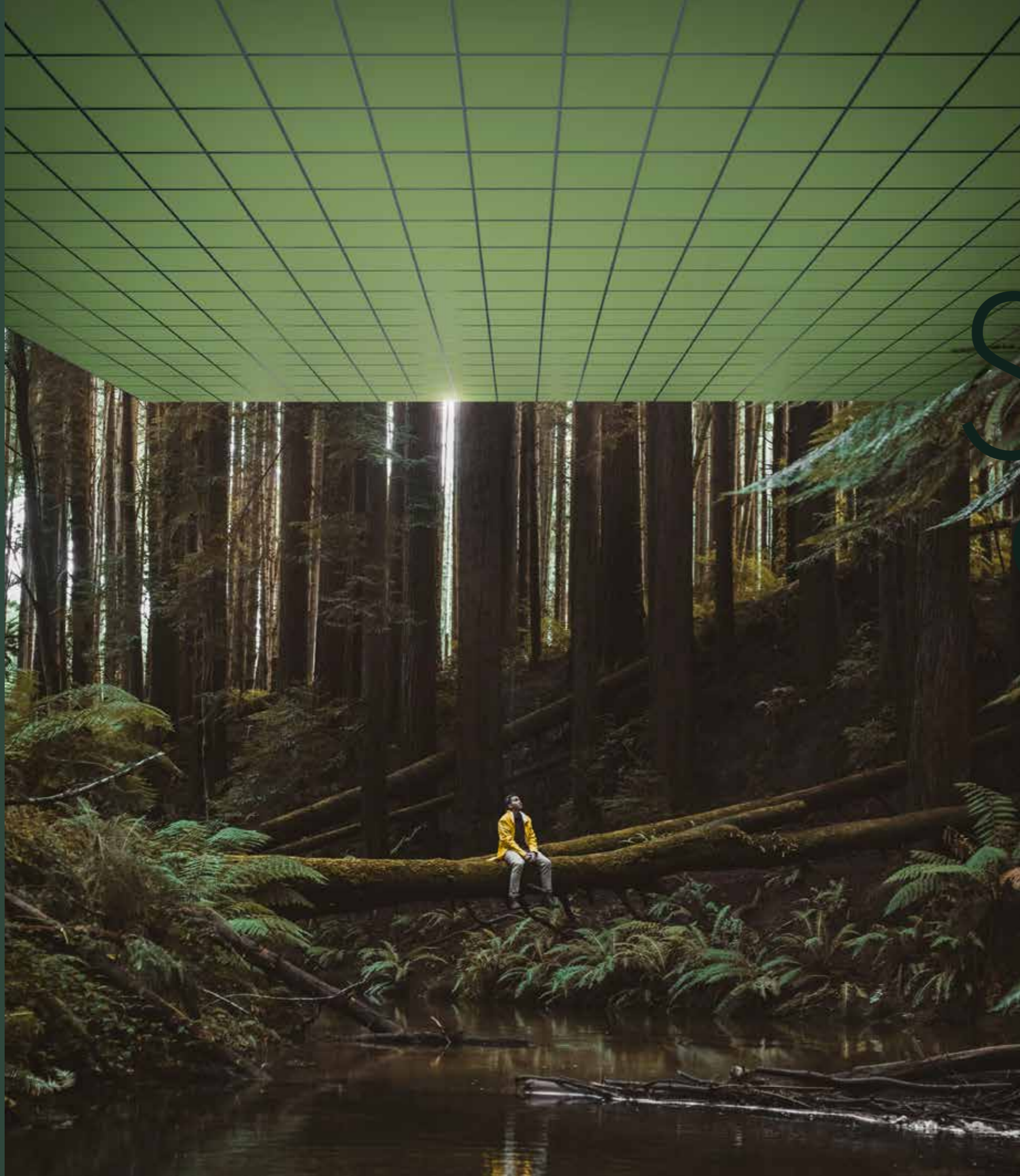

# Sound of nature

## IN EVERYDAY LIFE

Saint-Gobain Ecophon contributes to good indoor environments for working, healing and learning. We do this by developing, manufacturing and delivering acoustic products and systems designed around the natural evolution of human hearing – replicating the outdoor sound experience indoors, because that's just better for people.

Having a sound effect on people, in every way we can, is what we do proudly. That promise makes every one of us a passionate advocate for the importance of room acoustics to people's wellbeing – whatever the space, activity or need.



# Good acoustics

## MATTER EVERYWHERE

The importance of acoustics is underappreciated. Sound impacts us in daily life, and the scientific support for improving our indoor sound environments is well-documented.

And what exactly is an ideal indoor sound environment for people? One based on how we experience sound outside. The human auditory sense is naturally adapted to an outdoor environment where there is not any sound reflections from ceilings and walls.

That's why most of what we do at Ecophon is about replicating the acoustic qualities found in nature for indoor environments. We want to optimise indoor spaces to our natural way of hearing, so that speech and sound is easy to hear and understand, when needed, improving performance and wellbeing.

Usually that starts with the ceiling. A wall-to-wall acoustic ceiling is the easiest way to get a large sound-absorbing surface area into a space, and is usually the best way to reduce sound strength, shorten reverberation times, and increase speech clarity and overall hearing comfort.

But for a truly optimal sound environment, you'll also likely need different kinds of sound absorbers placed strategically throughout the space—wall-mounted panels and free-standing dividers are just two examples. In other words, a holistic approach is the best way to reduce the overall sound level and sound propagation in a room. Ecophon is here to help.

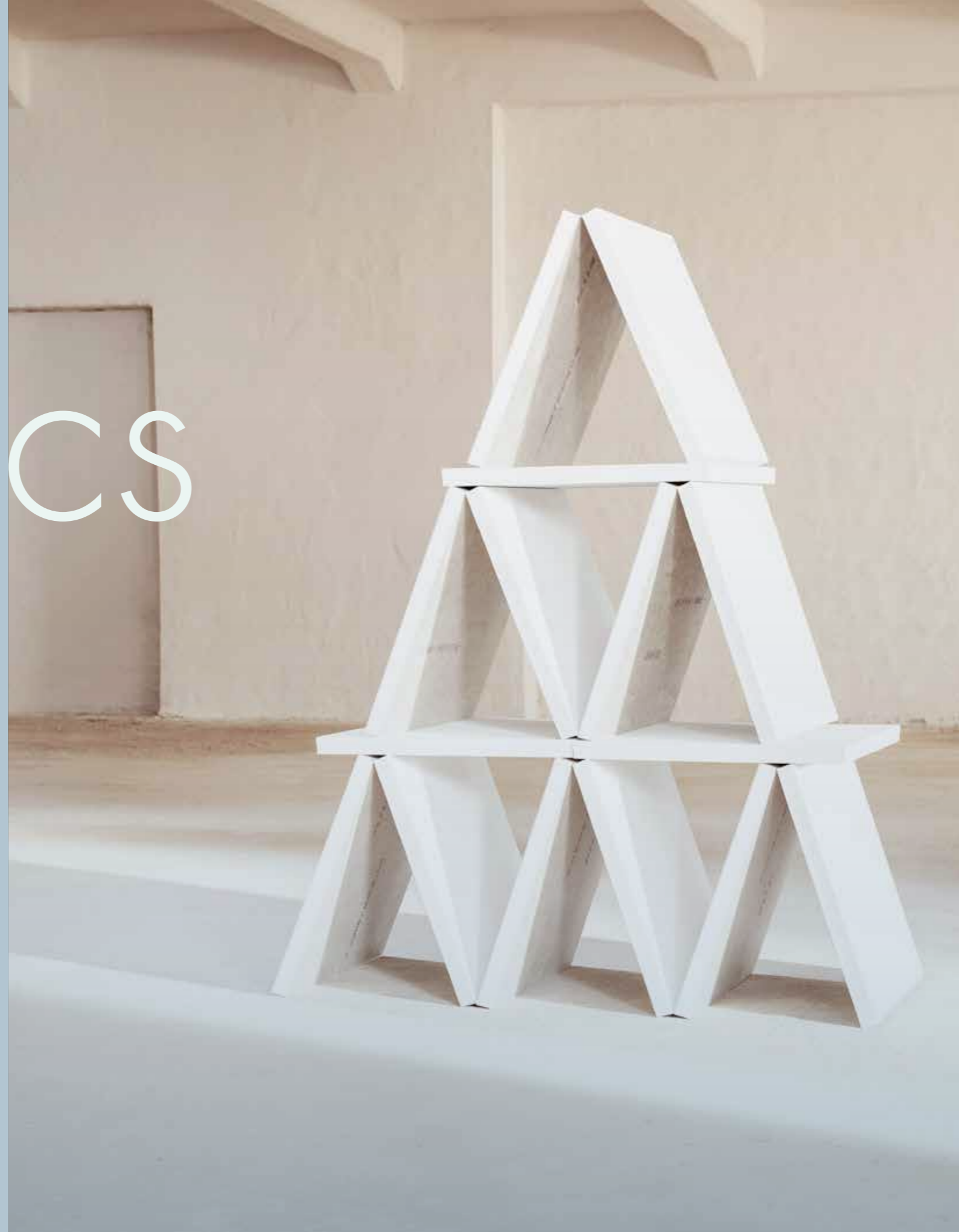





# Sustainability

## AS A GUIDING LIGHT

At Ecophon, sustainability is at the core of who we are and how we work. It's a promise to do better every day, in every way, for our co-workers, customers and partners in all walks of life. It's an approach to innovation that always sides with nature, and that takes its cue from the needs and environments of the people who will ultimately benefit from it. And it's a commitment to take as little as possible to do more than expected, so that future generations get to experience this planet at its life-sustaining best.

We are proud that all our products are united by their sustainability-driven origins. That applies to the materials we choose, but also to everything from the clean energy we use in our production facilities to the transparency, traceability and accountability embedded in every stage of product and service development, from idea to innovation. This is what makes us reach an industry-low carbon footprint. Because credible sustainability demands a holistic effort that leaves no challenge unaddressed, no opportunity unexplored. And fulfills the promise that ultimately drives all of us at Ecophon – to have a sound effect on people.





# Ecophon Solo™

## EXPERIENCING FREEDOM OF EXPRESSION

The ever on-point trend Ecophon Solo™ allows freedom of design and opportunity to create striking new expressions. The free-hanging panels and system are all 40 mm thick and come in all the shapes, colours and sizes you need to fulfil your artistic ideas.

- Superior acoustic qualities
- Available in a wide range of shapes
- Freedom of design with numerous colours, sizes and surface choices

Solo is well-suited to projects where a wall-to-wall solution is not an option, undesired or in need of improvement. Think lobbies, atriums, historic buildings, restaurants or shopping centres, among others. Hanging Ecophon Solo units directly over work areas, receptions and information counters, as well as other strategic points throughout the space, can improve speech, hearing and acoustic comfort considerably.

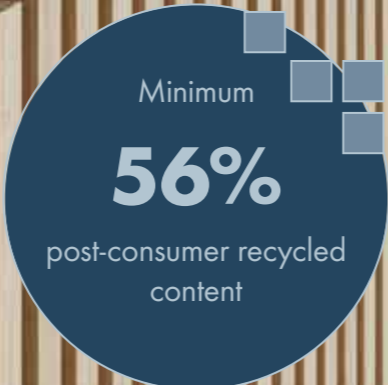



Industry-low  
**CO<sub>2</sub> emissions**  
 with exceptional  
 raw materials and wide  
 use of renewable  
 energies

**ECOPHON SOLO™ PRODUCT RANGE**

With Solo you can choose between a variety of shapes, sizes and colours, create your own unique Solo shape with Solo Freedom or explore the design features of Solo Textile.

Hanging from the ceiling, baffles can be used to form distinct lines, rolling waves or zig-zaggy patterns.

Mounted on walls, they add interesting contours and depth to any space. It is just as easy to mount as it is pleasing to look at.

Add perfection to your free hanging installation by using Solo Matrix where the grid offer precision but keep the floating, free hanging impression.

**SOLO SQUARE**

1200x1200x40



**SOLO RECTANGLE**

1800x1200x40  
 2400x600x40  
 2400x1200x40  
 3000x1200x40



**SOLO RECTANGLE LINE**

2400x1200x40



**SOLO CIRCLE**

Ø 800x40  
 Ø 1200x40



**SOLO TEXTILE**

1200x1200x40



**SOLO CIRCLE XL**

Ø 1600x40



**SOLO FREEDOM**

≤ 2400x1200x40

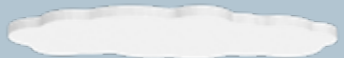

**SOLO BAFFLE**

1200x200x40  
 1200x300x40  
 1200x600x40  
 1800x200x40  
 1800x300x40  
 1800x600x40



**SOLO BAFFLE WAVE**

1800x300x40  
 1800x600x40



**SOLO BAFFLE ZIGZAG**

1800x300x40  
 1800x600x40



**SOLO BAFFLE WALL**

1200x200x40  
 1200x300x40



**SOLO MATRIX**

MODULES:	ROWS:
600x1200x40	600x1040x40
600x2400x40	1200x1040x40
1200x1200x40	2400x1040x40
2400x1200x40	







**SOLO SQUARE**  
Design possibilities with colours and three different suspension system to choose from.



**SOLO RECTANGLE LINE**  
Integrated recessed luminaire with high level of output, giving a distinctive expression.



**SOLO RECTANGLE**  
Design possibilities with large sizes and colours. Three different suspension system to choose from.

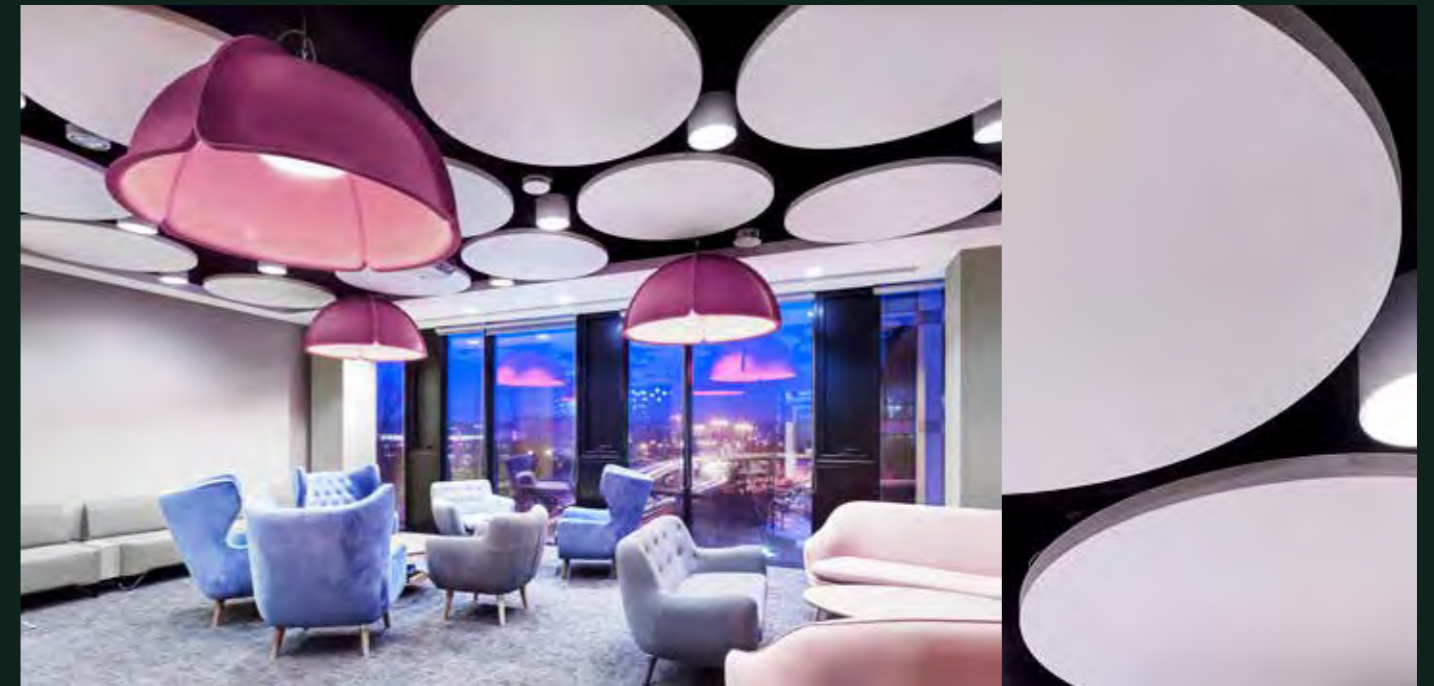
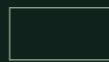

**SOLO CIRCLE**  
Design possibilities with colours and three different suspension system to choose from.







**SOLO CIRCLE XL**  
Design possibilities with colours. A large Circle consisting of two semicircles.



**SOLO TEXTILE**  
A panel with elegance, fully covered in textile. Available in colours.



**SOLO FREEDOM**  
Custom-made shapes with your own design or use one of our six standard shapes.



**SOLO BAFFLE**  
Design possibilities with colours and different sizes in a vertical installation.

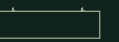





**SOLO BAFFLE WAVE**  
A baffle shaped like a wave, design possibilities with colours.

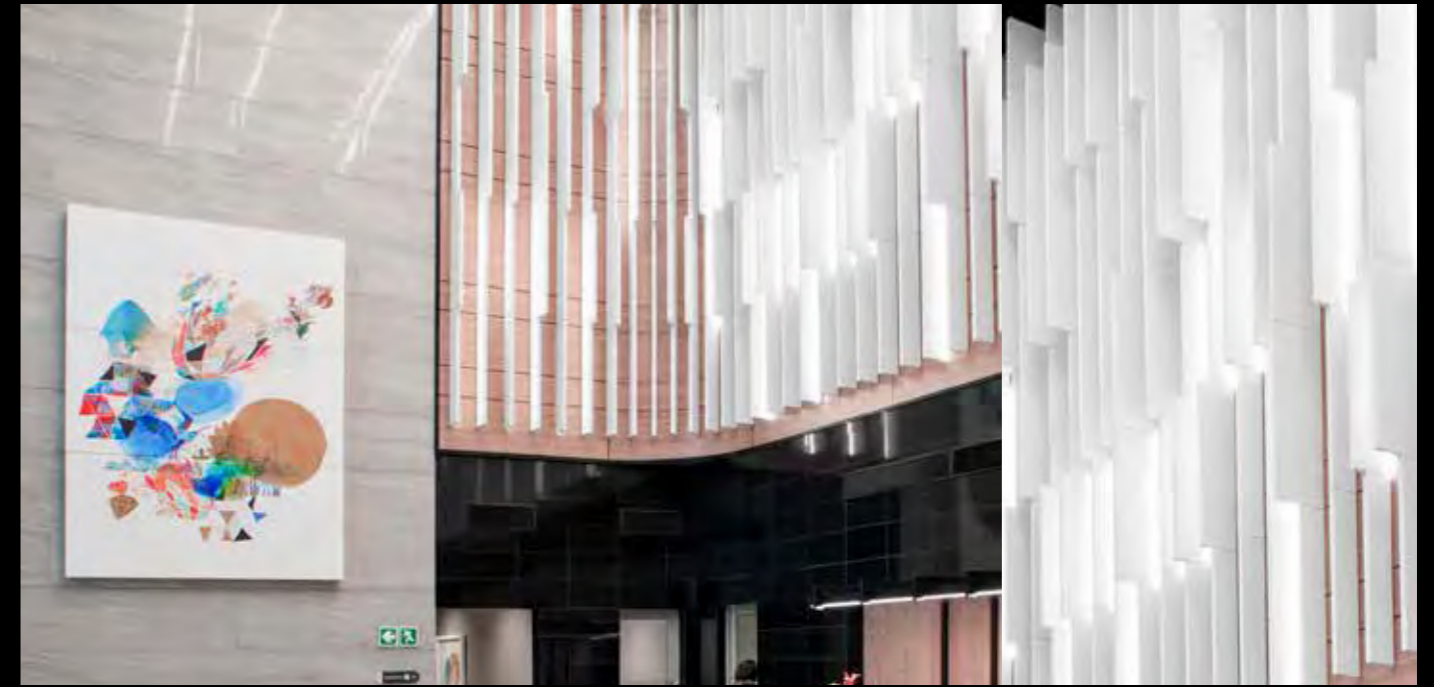

**SOLO BAFFLE WALL**  
Wall installation with design possibilities in different colours, add depths to any space.



**SOLO BAFFLE ZIGZAG**  
A baffle shaped like zigzag, design possibilities with colours.



**SOLO MATRIX**  
A vast range of design possibilities. Each panel has a built in hatch function, and can easily be demounted.





## INSTALLATION METHODS

Ecophon Solo offers a variety of mounting methods to meet market requirements for different installations, both for wall and ceiling.

Enjoy freedom of expression with a variety of installation styles.

## ECOPHON E-TOOLS

Ecophon offers several useful tools and services for the different phases of the building process, from inspiration to specific maintenance instructions for your Ecophon products.

Read more and try our E-tools at [www.ecophon.com](http://www.ecophon.com)



**DIRECT INSTALLATION** close to the soffit with Connect Absorber Bracket and Connect Absorber Anchor.

The brackets are available in adjustable lengths of 50-70 mm and 70-90 mm.



**SUSPENDED WIRE INSTALLATION** with Connect Adjustable Wire Hanger.

Suspended wire mounting can also be done with an angle of up to 45° and in multi-levels.

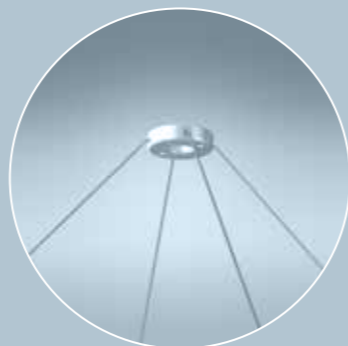

**CONNECT ONE-POINT FIXING** with Connect Absorber Anchor and Connect Adjustable Wire Hanger.

The installation has a discrete design and reduces the amount of fixations in the soffit.

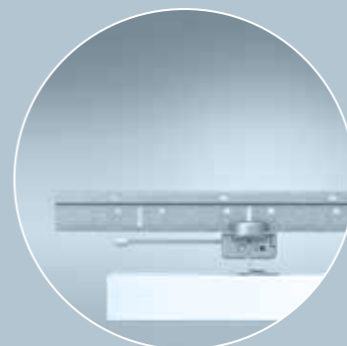

**SOLO MATRIX INSTALLATION** can be done in modules or rows with Connect grid system. The pre-installed anchors and click-in connection to the grid system gives a free hanging design with the accuracy of a grid system.

The Connect Nonius Hangers is available in a range of different lengths.

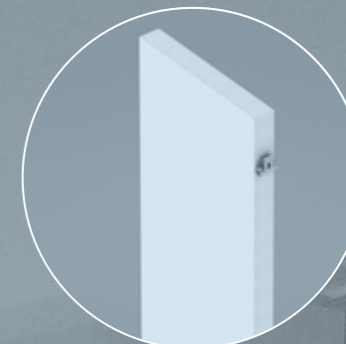









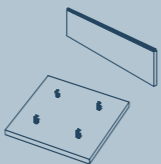
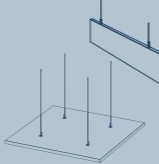
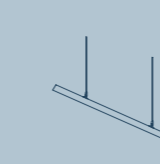
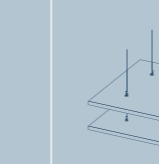
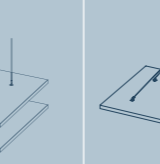
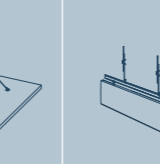
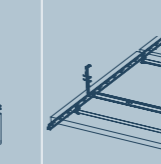
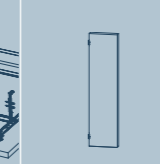





**BAFFLE INSTALLATION** can be done as direct installation using Solo Baffle Anchor and Connect Baffle Profiles or Connect Baffle Wall Fixing.

For suspended mounting Connect Adjustable Wire Hanger or Connect grid system can be used with Solo Baffle Hook.



# ECOPHON SOLO OVERVIEW

Shape	Product	Size (mm)	Installation methods								Wall	Surface	
			Direct	Suspended with wire	Suspended with wire, angle ≤45°	Suspended, with wire, multi-level	Suspended with wire, one-point	Suspended with Connect grid	Suspended in Connect grid				
													
	Ecophon Solo Square	1200x1200x40	•	•	•	•	•					Akutex FT	
	Ecophon Solo Rectangle	2400x600x40	•	•	•	•						Akutex FT	
		1800x1200x40	•	•	•	•							
		2400x1200x40	•	•	•	•	•						
		3000x1200x40		•									
	Ecophon Solo Rectangle Line	2400x1200x40		•								Akutex FT	
	Ecophon Solo Matrix (Modules)	600x1200x40								•		Akutex FT	
		600x2400x40								•			
		1200x1200x40								•			
		2400x1200x40								•			
	Ecophon Solo Matrix (Rows)	600x1040x40								•			
		1200x1040x40								•			
		2400x1040x40								•			
	Ecophon Solo Circle	Ø 800x40	•	•	•	•						Akutex FT	
		Ø 1200x40	•	•	•	•	•						
	Ecophon Solo Circle XL	Ø 1600x40		•								Akutex FT	
	Ecophon Solo Freedom	≤2400x1200x40	•	•	•	•						Akutex FT	
	Ecophon Solo Textile	1200x1200x40	•	•								Ecophon Textile	
	Ecophon Solo Baffle	1200x200x40	•	•					•			Akutex FT	
		1200x300x40	•	•					•				
		1200x600x40	•	•					•				
		1800x200x40	•	•					•				
		1800x300x40	•	•					•				
		1800x600x40	•	•					•				
	Ecophon Solo Baffle Wave	1800x300/200x40	•	•					•			Akutex FT	
		1800x600/300x40	•	•					•				
	Ecophon Solo Baffle ZigZag	1800x300/200x40	•	•					•			Akutex FT	
		1800x600/300x40	•	•					•				
	Ecophon Solo Baffle Wall	1200x200x40									•	Akutex FT	
		1200x300x40									•		



Ecophon Solo panels contribute to a healthy indoor environment with superior acoustic absorption, low VOC emissions in line with the strictest requirements, and a full chemical transparency with verified Health Product Declarations. The low environmental footprint of our Solo panels is third-party verified in Environmental Product Declarations.

**NOTE**  
More product and system information such as installation help and sustainability documentation can be found at [www.ecophon.com](http://www.ecophon.com)



## COLOURS AND SURFACES

### AKUTEX™ FT

The Akutex label guarantees that the product carrying it has a superior surface technology. Our research and development will always focus on visual aspects, acoustic properties, working environment, architectural trends and environmental aspects. This ensures that Akutex is always one step ahead.



**WHITE FROST**  
Nearest NCS colour sample S 0500-N.  
Light reflectance 85%.



**OCEAN STORM**  
Nearest NCS colour sample S 4020-R90B.  
Light reflectance 24%.



**MORNING DRIZZLE**  
Nearest NCS colour sample S 1002-B.  
Light reflectance 69%.



**VOLCANIC ASH**  
Nearest NCS colour sample S 2002-Y.  
Light reflectance 56%.



**MOONLIGHT SKY**  
Nearest NCS colour sample S 7020-R90B.  
Light reflectance 7%.



**CLOUDY DAY**  
Nearest NCS colour sample S 1500-N.  
Light reflectance 62%.



**SILVER STONE**  
Nearest NCS colour sample S 4502-Y.  
Light reflectance 29%.



**GOLDEN FIELD**  
Nearest NCS colour sample S 1040-G90Y.  
Light reflectance 61%.



**PEACH ROSE**  
Nearest NCS colour sample S 1515-Y80R.  
Light reflectance 55%.



**SILK SLATE**  
Nearest NCS colour sample S 7000-N.  
Light reflectance 13%.



**SUNSET HEAT**  
Nearest NCS colour sample S 2070-Y60R.  
Light reflectance 20%.



**HIGHLAND FOG**  
Nearest NCS colour sample S 2005-G.  
Light reflectance 55%.



**GOJI BERRY**  
Nearest NCS colour sample S 3030-Y80R.  
Light reflectance 27%.



**RUBY ROCK**  
Nearest NCS colour sample S 4050-R10B.  
Light reflectance 7%.



**SAGE GARDEN**  
Nearest NCS colour sample S 3010-B30G.  
Light reflectance 40%.



**SILENT STEAM**  
Nearest NCS colour sample S 2010-B.  
Light reflectance 45%.



**EUCALYPTUS LEAF**  
Nearest NCS colour sample S 5010-B30G.  
Light reflectance 23%.



**FRESH CLOVER**  
Nearest NCS colour sample S 3020-G40Y.  
Light reflectance 35%.



**SCALLOP SHELLS**  
Nearest NCS colour sample S 0804-Y50R.  
Light reflectance 76%.



**SUMMER FOREST**  
Nearest NCS colour sample S 6030-G10Y.  
Light reflectance 10%.



**WET SAND**  
Nearest NCS colour sample S 3020-Y30R.  
Light reflectance 35%.



**DARK DIAMOND**  
Nearest NCS colour sample S 9000-N.  
Light reflectance 4%.

#### NOTE

Colours may vary slightly between different production batches.  
Reproduction of colours vary between print and reality.

### ECOPHON TEXTILE

Ecophon Textile gives you the ability to create good acoustics that look at once understated and eye catching. The subtle pattern is made from a high-quality knitted material using the pique technique. It's characterised by a texture of fine ribbing, giving it a soft glow when light shines on the surface.



**PEACEFUL**  
Nearest NCS colour sample S 3010-G80Y.  
Light reflectance 37%.



**GENUINE**  
Nearest NCS colour sample S 7005-R80B.  
Light reflectance 10%.



**RELIABLE**  
Nearest NCS colour sample S 3502-Y.  
Light reflectance 37%.



**FEARLESS**  
Nearest NCS colour sample S 9000-N.  
Light reflectance 2%.



**CURIOS**  
Nearest NCS colour sample S 3030-B.  
Light reflectance 29%.



**PASSIONATE**  
Nearest NCS colour sample S 2030-R20B.  
Light reflectance 33%.



**CONFIDENT**  
Nearest NCS colour sample S 6020-R90B.  
Light reflectance 9%.

#### NOTE

Limited colour variation may occur between batches.  
Ecophon Textile fabrics have been designed for long durability, regular dusting according to Ecophon specifications and limited exposure to direct UVs are recommended to increase the lifespan of the products. Reproduction of colours vary between print and reality.



Acoustic ceiling products is amongst the largest surface in a room. It will affect not only the entire look and feel of the interior, but also the end-users' wellbeing. Ecophon has developed different types of surfaces and in different colours to suit most types of environments.



# System properties

## ACOUSTICS, TECHNICAL PROPERTIES AND INSTALLATION DIAGRAMS

- 28 Solo Square
- 30 Solo Rectangle
- 32 Solo Rectangle Line
- 34 Solo Matrix
- 36 Solo Circle
- 38 Solo Circle XL
- 40 Solo Freedom
- 42 Solo Textile
- 44 Solo Baffle
- 46 Solo Baffle Wave
- 48 Solo Baffle ZigZag
- 50 Solo Baffle Wall



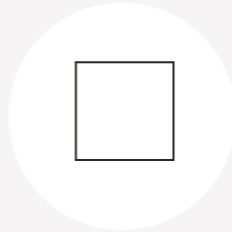

# Ecophon Solo™ Square

**Acoustic:** The values in the diagram refer to a single unit. If the units are arranged in a cluster with distances between units less than 0,5 meters, the Aeq per unit will be slightly reduced.

**Sound Absorption:**  
Test results according to EN ISO 354.

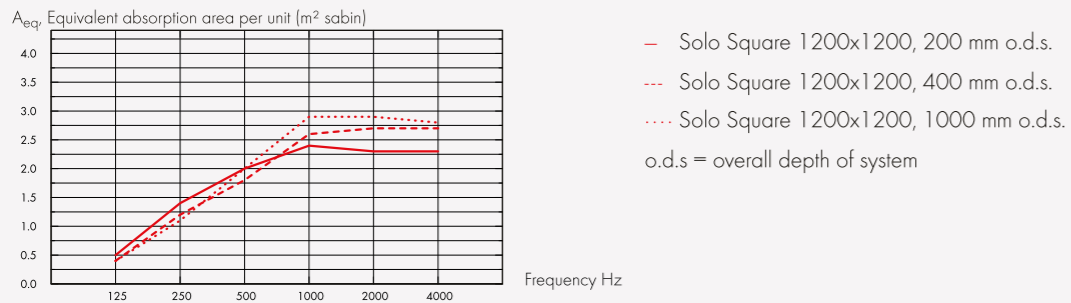

THK mm	o.d.s. mm	A <sub>eq</sub> Equivalent absorption area per unit (m <sup>2</sup> sabin)					
		125 Hz	250 Hz	500 Hz	1000 Hz	2000 Hz	4000 Hz
40	200	0.5	1.4	2.0	2.4	2.3	2.3
40	400	0.4	1.2	1.8	2.6	2.7	2.7
40	1000	0.4	1.1	2.0	2.9	2.9	2.8

**Indoor Air Quality:**

Certificate / Label	
Eurofins Indoor Air Comfort®	IAC
French VOC	A
Finnish M1	•

**Environmental Footprint:** Solo Square: 9,37 (Solo Family EPD in conformity with ISO 14025 / EN 15804),

**Circularity:** Minimum post-consumer recycled content: 57%, Recyclability: Fully recyclable,

**Fire safety:** The glass wool core of the tiles is tested and classified as non-combustible according to EN ISO 1182. Europe: EN 13501-1, A2-s1,d0,

**Humidity Resistance:** Class C, relative humidity 95% and 30°C, according to EN 13964:2014

**Visual appearance:** White Frost, nearest NCS colour sample S 0500-N, 85% light reflectance. Gloss < 1.

**Cleanability:** Daily dusting and vacuum cleaning. Weekly wet wiping.

**Accessibility:** The tiles are demountable.

**Installation:** Installed according to installation diagrams, installation guides and drawing aid. For information regarding minimum overall depth of system see quantity specification.

**System weight:** Approximately 6.5 kg (4.5 kg/m<sup>2</sup>).

**Mechanical properties:** The tile can take both point loads and distributed loads. See Functional demands, Mechanical properties at [www.ecophon.com](http://www.ecophon.com).

**CE:** Ecophon ceiling systems are CE marked according to the European harmonized standard EN 13964:2014. CE marked construction products are covered by a Declaration of Performance (DOP) which enables customers and users to easily compare performance of products available on the European market.

**Installation diagram in detail [www.ecophon.com](http://www.ecophon.com)**

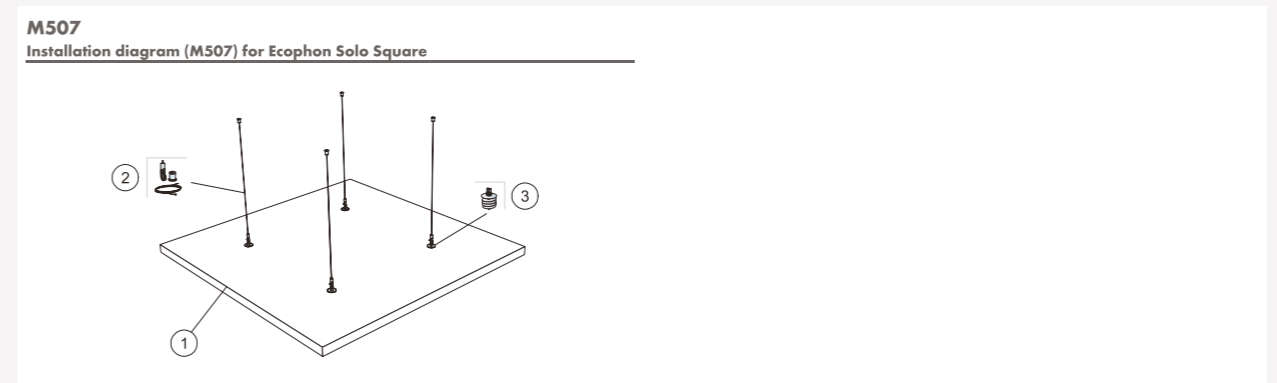



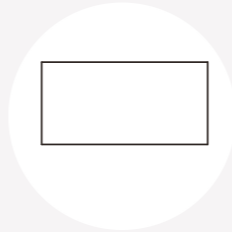

# Ecophon Solo™ Rectangle

**Acoustic:** The values in the diagram refer to a single unit. If the units are arranged in a cluster with distances between units less than 0,5 meters, the Aeq per unit will be slightly reduced.

**Sound Absorption:**  
Test results according to EN ISO 354.

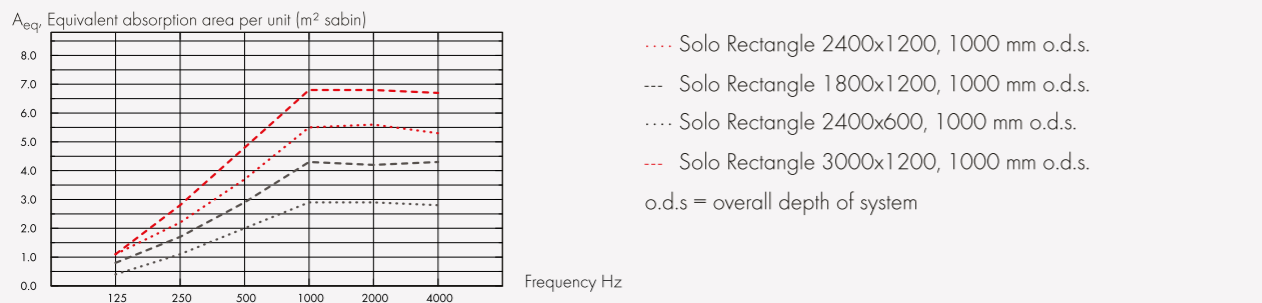

	THK mm	o.d.s. mm	A <sub>eq</sub> Equivalent absorption area per unit (m² sabin)					
			125 Hz	250 Hz	500 Hz	1000 Hz	2000 Hz	4000 Hz
2400x1200	40	200	1.3	2.8	3.5	4.1	4.1	3.9
2400x1200	40	400	1.2	2.4	3.3	4.7	4.9	4.7
2400x1200	40	1000	1.1	2.2	3.7	5.5	5.6	5.3
1800x1200	40	200	0.6	2.0	2.9	3.4	3.3	3.1
1800x1200	40	400	0.8	1.9	2.6	3.7	3.7	3.6
1800x1200	40	1000	0.8	1.7	2.9	4.3	4.2	4.3
2400x600	40	200	0.5	1.4	2.0	2.4	2.3	2.3
2400x600	40	400	0.4	1.2	1.8	2.6	2.7	2.7
2400x600	40	1000	0.4	1.1	2.0	2.9	2.9	2.8
3000x1200	40	200	1.1	3.3	4.4	5.1	5.1	5.0
3000x1200	40	400	1.2	3.0	4.2	5.8	5.8	5.7
3000x1200	40	1000	1.1	2.8	4.8	6.8	6.8	6.7

**Indoor Air Quality:**

Certificate / Label	
Eurofins Indoor Air Comfort®	IAC
French VOC	A
Finnish M1	•

**Environmental Footprint:** Solo Rectangle: 9,12 (Solo Family EPD in conformity with ISO 14025 / EN 15804),

**Circularity:** Minimum post-consumer recycled content: 57%, Recyclability: Fully recyclable,

**Fire safety:** The glass wool core of the tiles is tested and classified as non-combustible according to EN ISO 1182. Europe: EN 13501-1, A2-s1,d0,

- Humidity Resistance:** Class C, relative humidity 95% and 30°C, according to EN 13964:2014
- Visual appearance:** White Frost, nearest NCS colour sample S 0500-N, 85% light reflectance. Gloss < 1.
- Cleanability:** Daily dusting and vacuum cleaning. Weekly wet wiping.
- Accessibility:** The tiles are demountable.
- Installation:** Installed according to installation diagrams, installation guides and drawing aid. For information regarding minimum overall depth of system see quantity specification.
- System weight:** Approximately 6,5-17,5 kg.
- Mechanical properties:** The tile can take both point loads and distributed loads. See Functional demands, Mechanical properties at [www.ecophon.com](http://www.ecophon.com).

**CE:** Ecophon ceiling systems are CE marked according to the European harmonized standard EN13964:2014. CE marked construction products are covered by a Declaration of Performance (DOP) which enables customers and users to easily compare performance of products available on the European market.

**Installation diagram in detail [www.ecophon.com](http://www.ecophon.com)**

**M404**  
Installation diagram (M404) for Ecophon Solo Rectangle 1800x1200

**M405**  
Installation diagram (M405) for Ecophon Solo Rectangle 2400x600

**M406**  
Installation diagram (M406) for Ecophon Solo Rectangle 2400x1200

**M407**  
Installation diagram (M407) for Ecophon Solo Rectangle 2400x1200

**M408**  
Installation diagram (M408) for Ecophon Solo Rectangle 3000x1200

**M506**  
Installation diagram (M506) for Ecophon Solo Rectangle

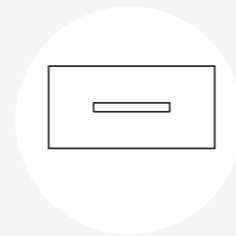

# Ecophon Solo™ Rectangle Line

**Acoustic:** For acoustic data on the panel - please see Solo Rectangle.

**Lighting performance:**

System effect: 29,4W Light source: LED 26,7 W Luminous flux: 2337 lm Light efficiency: 87,5 lm/W Colour temperature: 4000K Color rendering index: Ra ≥80 Colour tolerance: MacAdam ≤3 SDCM Light output ratio (LOR): 100% Light distribution up/down: 0/100 Expected lifespan: L90 >50 000 h Expected lifespan: L70 >100 000 h

**Connection:** The standard on/off electronic HF ballast delivered with 2,5 meters of cable 3x0,75 mm<sup>2</sup> and grounded plug. The SwitchDIM/DALI delivered without cable.

**Electrical data:** 220-240 V, 50-60 Hz, power factor cos φ>0,98. Electronic HF ballast or electronic HF dim ballast for digital regulation. Light source: led module of 26,7W total.

**Electrical approvals:** IP20, Class 1.

**Indoor Air Quality:**

Certificate / Label	
Eurofins Indoor Air Comfort®	IAC
French VOC	A
Finnish M1	•

**Circularity:** Minimum post-consumer recycled content: 57%, Recyclability: Fully recyclable,

**Fire safety:** The glass wool core of the tiles is tested and classified as non-combustible according to EN ISO 1182. Europe: EN 13501-1, A2-s1,d0,

**Humidity Resistance:** Class C, relative humidity 95% and 30°C, according to EN 13964:2014

**Visual appearance:** White Frost, nearest NCS colour sample S 0500-N, 85% light reflectance. Gloss < 1.

**Cleanability:** Daily dusting and vacuum cleaning. Weekly wet wiping.

**Accessibility:** The tiles are demountable.

**Installation:** Installed according to installation diagrams, installation guides and drawing aid. For information regarding minimum overall depth of system see quantity specification.

**CE:** Ecophon ceiling systems are CE marked according to the European harmonized standard EN13964:2014. CE marked construction products are covered by a Declaration of Performance (DOP) which enables customers and users to easily compare performance of products available on the European market.

## Installation diagram in detail [www.ecophon.com](http://www.ecophon.com)

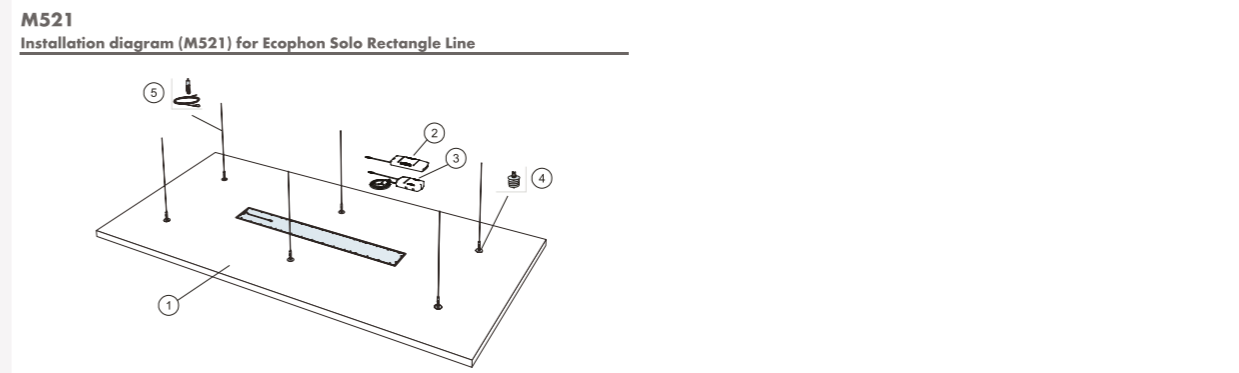



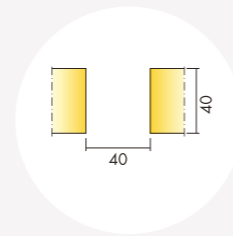

# Ecophon Solo™ Matrix

**Acoustic:** The first diagram refers to clusters >10 m². The second diagram to a cluster of four panels (1200x1040 mm) in a row with a distance of 40 mm (M502). If the clusters are arranged with distances between the clusters <0,5 meters, the Aeq per cluster will be slightly reduced.

**Sound Absorption:**

Test results according to EN ISO 354. Classification according to EN ISO 11654.

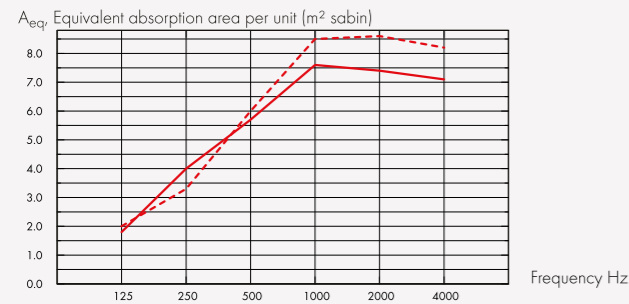
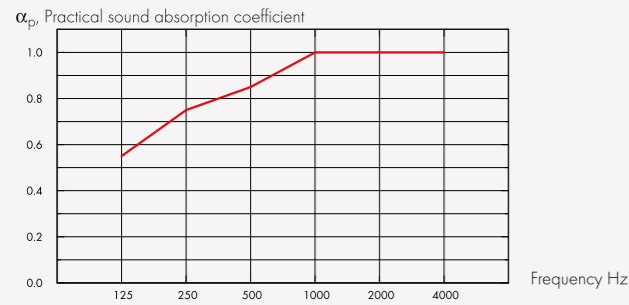

THK mm	o.d.s. mm	$\alpha_p$ Practical sound absorption coefficient						$\alpha_w$	Sound absorption class
		125 Hz	250 Hz	500 Hz	1000 Hz	2000 Hz	4000 Hz		
40	300	0.55	0.75	0.85	1.00	1.00	1.00	0.95	A

THK mm	o.d.s. mm	$A_{eq}$ Equivalent absorption area per unit (m² sabin)					
		125 Hz	250 Hz	500 Hz	1000 Hz	2000 Hz	4000 Hz
40	300	1.8	4.0	5.7	7.6	7.4	7.1
40	600	2.0	3.3	6.0	8.5	8.6	8.2
40	1000	2.1	3.5	6.4	9.1	9.2	9.0

**Indoor Air Quality:**

Certificate / Label	
Eurofins Indoor Air Comfort®	IAC
French VOC	A
Finnish M1	•

**Environmental Footprint:** Kg CO<sub>2</sub> equiv/m<sup>2</sup>: 4,36 From EPD in conformity with ISO 14025 / EN 15804  
Solo Matrix: 7,52 (Solo Family EPD in conformity with ISO 14025 / EN 15804),

**Circularity:** Minimum post-consumer recycled content: 59%, Recyclability: Fully recyclable,

**Fire safety:** The glass wool core of the tiles is tested and classified as non-combustible according to EN ISO 1182. Europe: EN 13501-1, A2-s1,d0,

**Humidity Resistance:** Class C, relative humidity 95% and 30°C, according to EN 13964:2014

**Visual appearance:** White Frost, nearest NCS colour sample S 0500-N, 85% light reflectance. Gloss < 1.

**Cleanability:** Daily dusting and vacuum cleaning. Weekly wet wiping.

**Accessibility:** Each panel is individually demountable from below. Panels are equipped with hatch function.

**Installation:** For design possibilities including installation direction and integrations, see installation guides, installation diagrams and drawing aid. For informatin regarding minimum overall depth of system see quantity specification.

**Mechanical properties:** The panels can take small loads with largest aperture diameter of 100 mm. The load is restricted to maximum 250g between two Panel cross bars. For heavier loads see Installation guide.

**CE:** Ecophon ceiling systems are CE marked according to the European harmonized standard EN13964:2014. CE marked construction products are covered by a Declaration of Performance (DOP) which enables customers and users to easily compare performance of products available on the European market.

**Installation diagram in detail [www.ecophon.com](http://www.ecophon.com)**

**M501**

Installation diagram (M501) for Ecophon Solo Matrix in modules

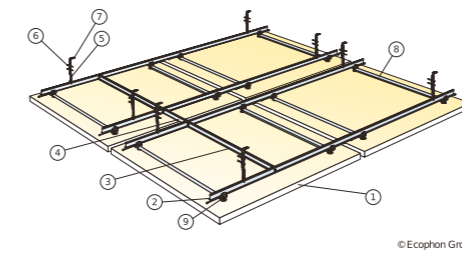

**M502**

Installation diagram (M502) for Ecophon Solo Matrix in rows

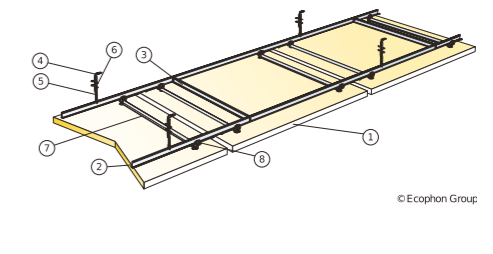

**M503**

Installation diagram (M503) for Ecophon Solo Matrix in modules

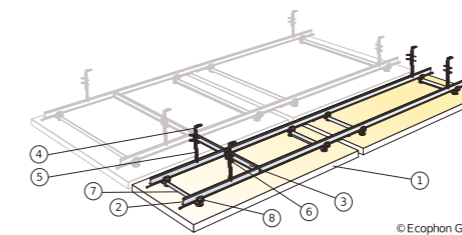



# Ecophon Solo™ Circle

**Acoustic:** The values in the diagram refer to a single unit. If the units are arranged in a cluster with distances between units less than 0,5 meters, the Aeq per unit will be slightly reduced.

**Sound Absorption:**  
Test results according to EN ISO 354.

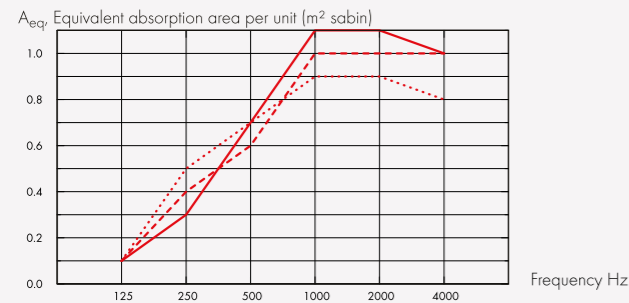

— Solo Circle Ø800, 200 mm o.d.s.  
 - - - Solo Circle Ø800, 400 mm o.d.s.  
 ... Solo Circle Ø800, 1000 mm o.d.s.  
 o.d.s = overall depth of system

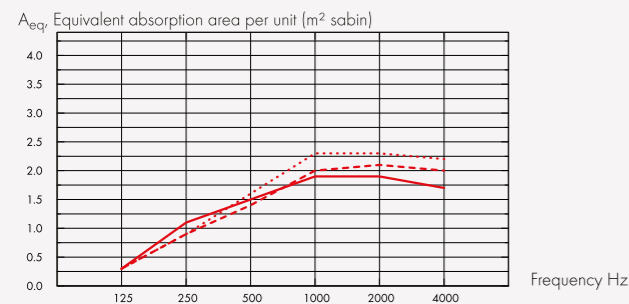

— Solo Circle Ø1200, 200 mm o.d.s.  
 - - - Solo Circle Ø1200, 400 mm o.d.s.  
 ... Solo Circle Ø1200, 1000 mm o.d.s.  
 o.d.s = overall depth of system

	THK mm	o.d.s. mm	A <sub>eq</sub> , Equivalent absorption area per unit (m <sup>2</sup> sabin)					
			125 Hz	250 Hz	500 Hz	1000 Hz	2000 Hz	4000 Hz
Ø800	40	200	0.1	0.3	0.7	1.1	1.1	1.0
Ø800	40	400	0.1	0.4	0.6	1.0	1.0	1.0
Ø800	40	1000	0.1	0.5	0.7	0.9	0.9	0.8

	THK mm	o.d.s. mm	A <sub>eq</sub> , Equivalent absorption area per unit (m <sup>2</sup> sabin)					
			125 Hz	250 Hz	500 Hz	1000 Hz	2000 Hz	4000 Hz
Ø1200	40	200	0.3	1.1	1.5	1.9	1.9	1.7
Ø1200	40	400	0.3	0.9	1.4	2.0	2.1	2.0
Ø1200	40	1000	0.3	0.9	1.6	2.3	2.3	2.2

## Indoor Air Quality:

Certificate / Label	
Eurofins Indoor Air Comfort®	IAC
French VOC	A
Finnish M1	•

**Environmental Footprint:** Solo Circle: 10,35 (Solo Family EPD in conformity with ISO 14025 / EN 15804),

**Circularity:** Minimum post-consumer recycled content: 57%, Recyclability: Fully recyclable,

**Fire safety:** The glass wool core of the tiles is tested and classified as non-combustible according to EN ISO 1182. Europe: EN 13501-1, A2-s1,d0,

**Humidity Resistance:** Class C, relative humidity 95% and 30°C, according to EN 13964:2014

**Visual appearance:** White Frost, nearest NCS colour sample S 0500-N, 85% light reflectance. Gloss < 1.

**Cleanability:** Daily dusting and vacuum cleaning. Weekly wet wiping.

**Accessibility:** The tiles are demountable.

**Installation:** Installed according to installation diagrams, installation guides and drawing aid. For information regarding minimum overall depth of system see quantity specification.

**System weight:** Approximately 2-4,5 kg.

**Mechanical properties:** The tile can take both point loads and distributed loads. See Functional demands, Mechanical properties at [www.ecophon.com](http://www.ecophon.com).

**CE:** Ecophon ceiling systems are CE marked according to the European harmonized standard EN 13964:2014. CE marked construction products are covered by a Declaration of Performance (DOP) which enables customers and users to easily compare performance of products available on the European market.

## Installation diagram in detail [www.ecophon.com](http://www.ecophon.com)

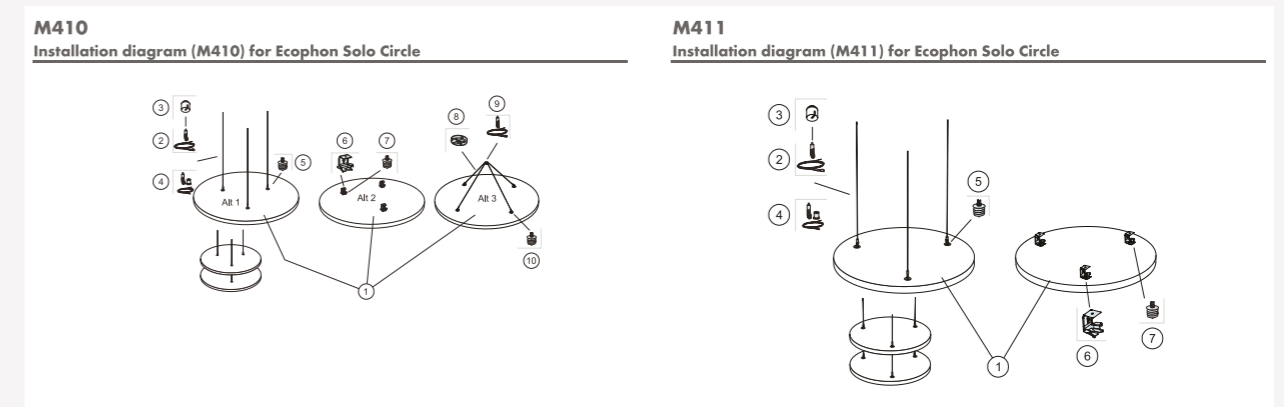





# Ecophon Solo™ Circle XL

**Acoustic:** The values in the diagram refer to a single unit. If the units are arranged in a cluster with distances between units less than 0,5 meters, the Aeq per unit will be slightly reduced.

**Sound Absorption:**  
Test results according to EN ISO 354.

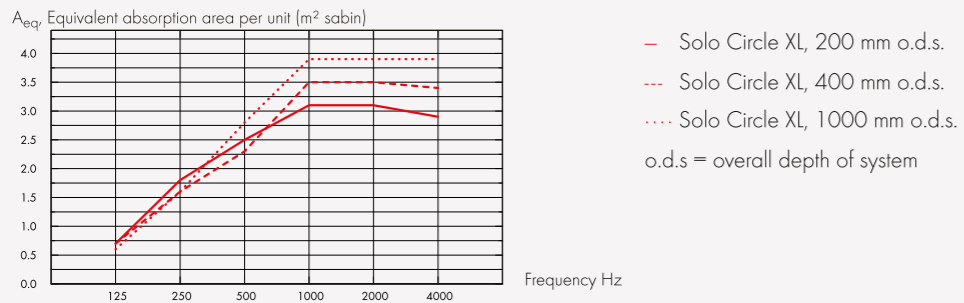

THK mm	o.d.s. mm	A <sub>eq</sub> Equivalent absorption area per unit (m <sup>2</sup> sabin)					
		125 Hz	250 Hz	500 Hz	1000 Hz	2000 Hz	4000 Hz
40	200	0.7	1.8	2.5	3.1	3.1	2.9
40	400	0.7	1.6	2.3	3.5	3.5	3.4
40	1000	0.6	1.6	2.8	3.9	3.9	3.9

## Indoor Air Quality:

Certificate / Label	
Eurofins Indoor Air Comfort®	IAC
French VOC	A
Finnish M1	•

**Circularity:** Minimum post-consumer recycled content: 57%, Recyclability: Fully recyclable,

**Fire safety:** The glass wool core of the tiles is tested and classified as non-combustible according to EN ISO 1182. Europe: EN 13501-1, A2-s1,d0,

**Humidity Resistance:** Class C, relative humidity 95% and 30°C, according to EN 13964:2014

**Visual appearance:** White Frost, nearest NCS colour sample S 0500-N, 85% light reflectance. Gloss < 1.

**Cleanability:** Daily dusting and vacuum cleaning. Weekly wet wiping.

**Accessibility:** The tiles are demountable.

**Installation:** Installed according to installation diagrams, installation guides and drawing aid. For information regarding minimum overall depth of system see quantity specification.

**System weight:** Approximately 8 kg.

**Mechanical properties:** No additional live load is allowed.

**CE:** Ecophon ceiling systems are CE marked according to the European harmonized standard EN13964:2014. CE marked construction products are covered by a Declaration of Performance (DOP) which enables customers and users to easily compare performance of products available on the European market.

## Installation diagram in detail [www.ecophon.com](http://www.ecophon.com)

### M290

Installation diagram (M290) for Ecophon Solo Circle XL

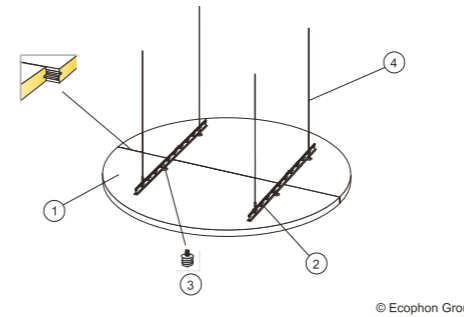

© Ecophon Group



# Ecophon Solo™ Freedom

**Acoustic:** For acoustic data on the panel - please see Solo Square and Rectangle.

**Indoor Air Quality:**

Certificate / Label	
Eurofins Indoor Air Comfort®	IAC
French VOC	A
Finnish M1	•

**Environmental Footprint:** Solo Freedom: 8,41 (Solo Family EPD in conformity with ISO 14025 / EN 15804),

**Circularity:** Minimum post-consumer recycled content: 57%, Recyclability: Fully recyclable,

**Fire safety:** The glass wool core of the tiles is tested and classified as non-combustible according to EN ISO 1182. Europe: EN 13501-1, A2-s1,d0,

**Humidity Resistance:** Class C, relative humidity 95% and 30°C, according to EN 13964:2014

**Visual appearance:** White Frost, nearest NCS colour sample S 0500-N, 85% light reflectance. Gloss < 1.

**Cleanability:** Daily dusting and vacuum cleaning. Weekly wet wiping.

**Accessibility:** The tiles are demountable.

**Installation:** Installed according to installation diagrams, installation guides and drawing aid. For information regarding minimum overall depth of system see quantity specification.

**Mechanical properties:** The tile can take both point loads and distributed loads. See Functional demands, Mechanical properties at [www.ecophon.com](http://www.ecophon.com).

**CE:** Ecophon ceiling systems are CE marked according to the European harmonized standard EN13964:2014. CE marked construction products are covered by a Declaration of Performance (DOP) which enables customers and users to easily compare performance of products available on the European market.

## Installation diagram in detail [www.ecophon.com](http://www.ecophon.com)

**M412**  
Installation diagram (M412) for Ecophon Solo Freedom

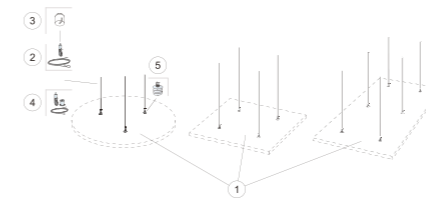

**M425**  
Installation diagram (M425) for Ecophon Solo Heptagon

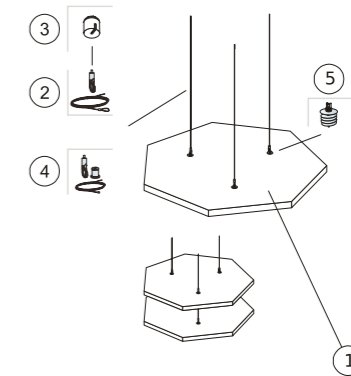

**M426**  
Installation diagram (M426) for Ecophon Solo Hexagon

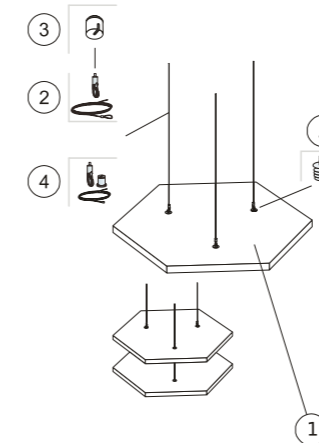

**M427**  
Installation diagram (M427) for Ecophon Solo Pentagon

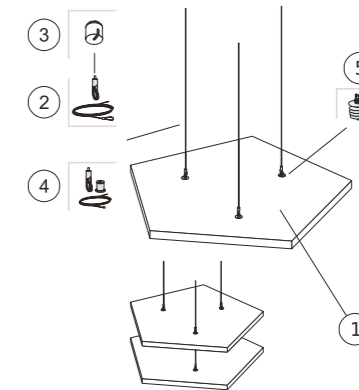

**M428**  
Installation diagram (M428) for Ecophon Solo Ellipse

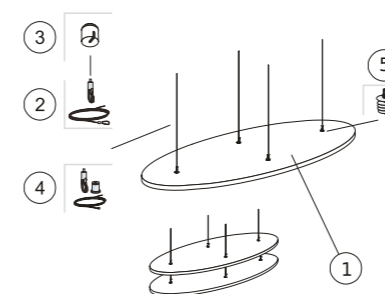

**M297**  
Installation diagram (M297) for Ecophon Solo Triangle

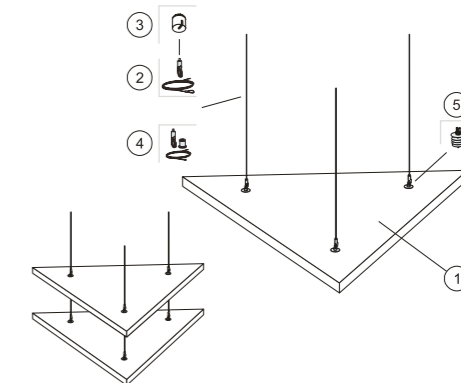



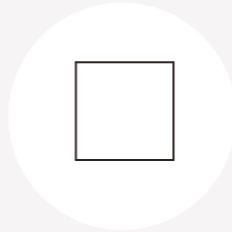

# Ecophon Solo™ Textile

**Acoustic:** The values in the diagram refer to a single unit. If the units are arranged in a cluster with distances between units less than 0,5 meters, the Aeq per unit will be slightly reduced.

**Sound Absorption:**  
Test results according to EN ISO 354.

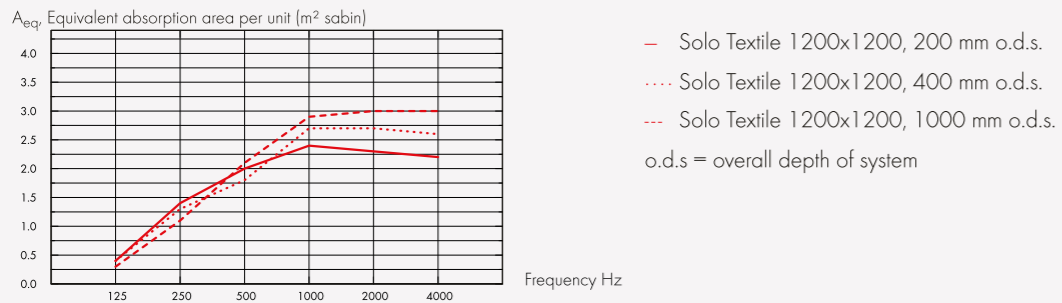

	THK mm	o.d.s. mm	A <sub>eq</sub> Equivalent absorption area per unit (m <sup>2</sup> sabin)					
			125 Hz	250 Hz	500 Hz	1000 Hz	2000 Hz	4000 Hz
1200x1200	40	200	0.4	1.4	2.0	2.4	2.3	2.2
1200x1200	40	400	0.4	1.3	1.8	2.7	2.7	2.6
1200x1200	40	1000	0.3	1.1	2.1	2.9	3.0	3.0

## Indoor Air Quality:

Certificate / Label

French VOC, A •

**Circularity:** Fully recyclable.

**Fire safety:** See table Europe: EN 13501-1, B-s1,d0,

**Humidity Resistance:** Class A, relative humidity 70% and 25°C, according to EN 13964:2014

**Visual appearance:** Light reflectance and nearest NCS colour sample for all the different colours: See Ecophon Colours and surfaces. (The tiles need to be installed in accordance with the installation guide in order to get optimal visual appearance).

**Cleanability:** Weekly dusting and vacuum cleaning.

**Accessibility:** The tiles are demountable.

**Installation:** Installed according to installation diagrams, installation guides and drawing aid. For information regarding minimum overall depth of system see quantity specification.

**System weight:** Approximately 7 kg.

**Mechanical properties:** No additional live load is allowed.

**CE:** Ecophon ceiling systems are CE marked according to the European harmonized standard EN13964:2014. CE marked construction products are covered by a Declaration of Performance (DOP) which enables customers and users to easily compare performance of products available on the European market.

## Installation diagram in detail [www.ecophon.com](http://www.ecophon.com)

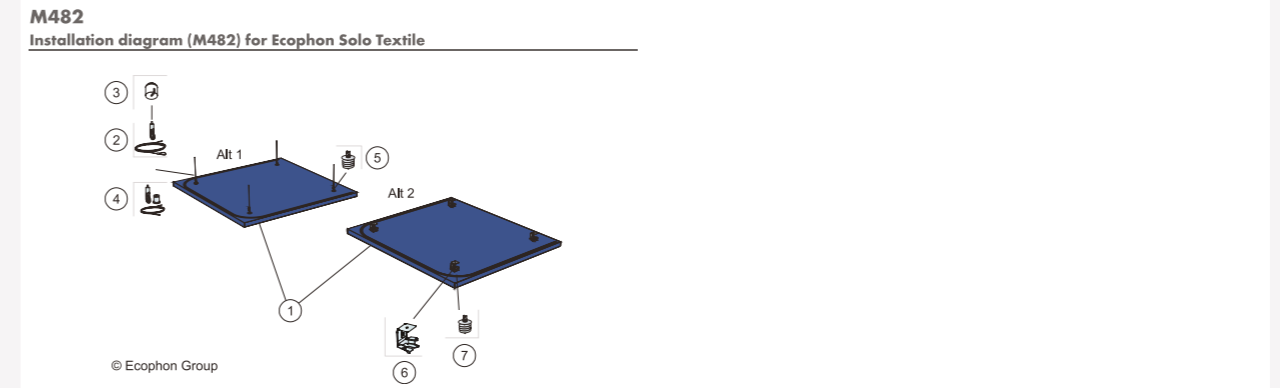



# Ecophon Solo™ Baffle

## Acoustic:

### Sound Absorption:

Test results according to EN ISO 354:2003 NOTE: Results shown are not comparable with results according to older versions of this standard due to discrepancies in test method. Classification according to EN ISO 11654, and the single value ratings for Noise Reduction Coefficient, NRC and Sound Absorption Average, SAA according to ASTM C 423.

$\alpha_p$ , Practical sound absorption coefficient

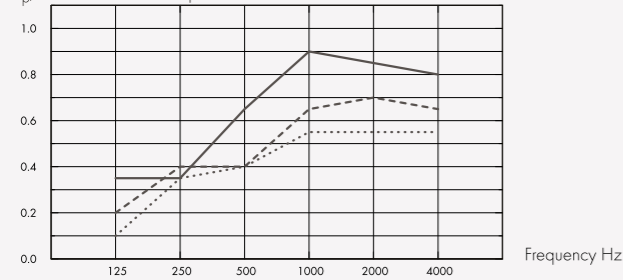

.... Solo Baffle 1200/1800x200, spacing 600mm, direct mounting  
 --- Solo Baffle 1200/1800x300, spacing 600mm, direct mounting  
 - Solo Baffle 1200/1800x600, spacing 600mm, direct mounting  
 o.d.s = overall depth of system

$A_{eq}$ , Equivalent absorption area per unit (m² sabin)

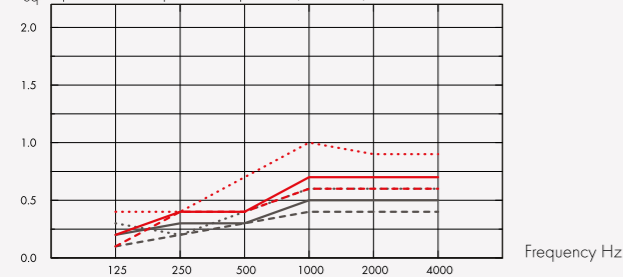

--- Solo Baffle 1200x200  
 - Solo Baffle 1200x300  
 .... Solo Baffle 1200x600  
 - - - Solo Baffle 1800x200  
 - Solo Baffle 1800x300  
 .... Solo Baffle 1800x600  
 o.d.s = overall depth of system

	THK mm	o.d.s. mm	$\alpha_p$ , Practical sound absorption coefficient						$\alpha_w$
			125 Hz	250 Hz	500 Hz	1000 Hz	2000 Hz	4000 Hz	
c600	40	200	0.10	0.35	0.40	0.55	0.55	0.55	0.50
c600	40	300	0.20	0.40	0.40	0.65	0.70	0.65	0.50
c600	40	600	0.35	0.35	0.65	0.90	0.85	0.80	0.65

	THK mm	o.d.s. mm	$A_{eq}$ , Equivalent absorption area per unit (m² sabin)					
			125 Hz	250 Hz	500 Hz	1000 Hz	2000 Hz	4000 Hz
1200x200c600	40	200	0.1	0.2	0.3	0.4	0.4	0.4
1200x300c600	40	300	0.2	0.3	0.3	0.5	0.5	0.5
1200x600c600	40	600	0.3	0.2	0.4	0.6	0.6	0.6
1800x200c600	40	200	0.1	0.4	0.4	0.6	0.6	0.6
1800x300c600	40	300	0.2	0.4	0.4	0.7	0.7	0.7
1800x600c600	40	600	0.4	0.4	0.7	1.0	0.9	0.9

## Indoor Air Quality:

Certificate / Label	
Eurofins Indoor Air Comfort®	IAC
French VOC	A
Finnish M1	•

**Environmental Footprint:** Solo Baffle: 10,11 (Solo Family EPD in conformity with ISO 14025 / EN 15804),

**Circularity:** Minimum post-consumer recycled content: 57%, Recyclability: Fully recyclable,

**Fire safety:** The glass wool core of the tiles is tested and classified as non-combustible according to EN ISO 1182. Europe: EN 13501-1, A2-s1,d0,

**Humidity Resistance:** Class C, relative humidity 95% and 30°C, according to EN 13964:2014

**Visual appearance:** White Frost, nearest NCS colour sample S 0500-N, 85% light reflectance. Gloss < 1.

**Cleanability:** Daily dusting and vacuum cleaning. Weekly wet wiping.

**Accessibility:** The tiles are demountable.

**Installation:** Installed according to installation diagrams, installation guides and drawing aid. For information regarding minimum overall depth of system see quantity specification.

**System weight:** Approximate weight of system 2-4 kg/m

**Mechanical properties:** Additional live load has to be fixed to the soffit.

**CE:** Ecophon ceiling systems are CE marked according to the European harmonized standard EN 13964:2014. CE marked construction products are covered by a Declaration of Performance (DOP) which enables customers and users to easily compare performance of products available on the European market.

## Installation diagram in detail [www.ecophon.com](http://www.ecophon.com)

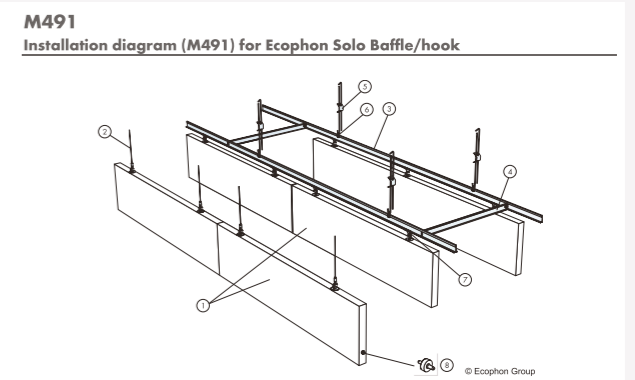
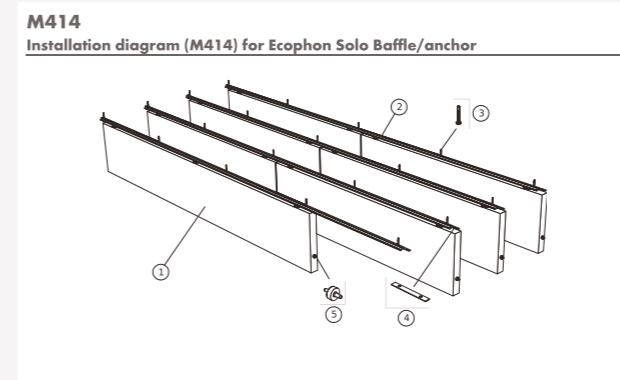



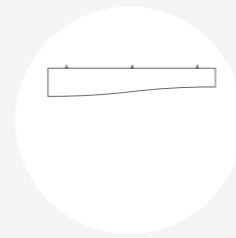

# Ecophon Solo™ Baffle Wave

## Acoustic:

### Sound Absorption:

Test results according to EN ISO 354:2003 NOTE: Results shown are not comparable with results according to older versions of this standard due to discrepancies in test method. Classification according to EN ISO 11654, and the single value ratings for Noise Reduction Coefficient, NRC and Sound Absorption Average, SAA according to ASTM C 423.

$\alpha_p$ , Practical sound absorption coefficient

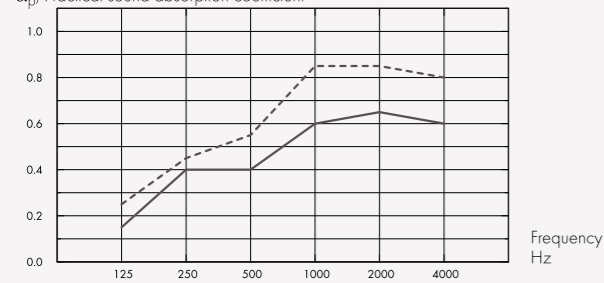

- Solo Baffle Wave 1800x300/200, spacing 600, direct mounting
  - Solo Baffle Wave 1800x600/300, spacing 600, direct mounting
- o.d.s = overall depth of system

$A_{eq}$ , Equivalent absorption area per unit (m<sup>2</sup> sabin)

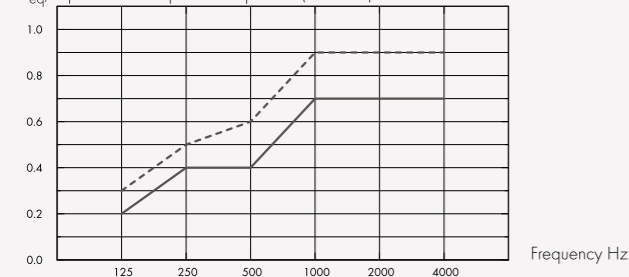

- Solo Baffle Wave 1800x300/200
  - Solo Baffle Wave 1800x600/300
- o.d.s = overall depth of system

	THK mm	o.d.s. mm	$\alpha_p$ , Practical sound absorption coefficient					$\alpha_w$	
			125 Hz	250 Hz	500 Hz	1000 Hz	2000 Hz		4000 Hz
c600	40	300	0.15	0.40	0.40	0.60	0.65	0.60	0.50
c600	40	600	0.25	0.45	0.55	0.85	0.85	0.80	0.65

	THK mm	o.d.s. mm	$A_{eq}$ , Equivalent absorption area per unit (m <sup>2</sup> sabin)					
			125 Hz	250 Hz	500 Hz	1000 Hz	2000 Hz	4000 Hz
c600	40	300	0.2	0.4	0.4	0.7	0.7	0.7
c600	40	600	0.3	0.5	0.6	0.9	0.9	0.9

	THK mm	o.d.s. mm	NRC	SAA
c600	40	300	0.50	0.52
c600	40	600	0.70	0.68

## Indoor Air Quality:

Certificate / Label	
Eurofins Indoor Air Comfort®	IAC
French VOC	A
Finnish M1	•

**Environmental Footprint:** Solo Baffle Wave: 11,07 (Solo Family EPD in conformity with ISO 14025 / EN 15804),

**Circularity:** Minimum post-consumer recycled content: 57%, Recyclability: Fully recyclable,

**Fire safety:** The glass wool core of the tiles is tested and classified as non-combustible according to EN ISO 1182. Europe: EN 13501-1, A2-s1,d0,

**Humidity Resistance:** Class C, relative humidity 95% and 30°C, according to EN 13964:2014

**Visual appearance:** White Frost, nearest NCS colour sample S 0500-N, 85% light reflectance. Gloss < 1.

**Cleanability:** Daily dusting and vacuum cleaning. Weekly wet wiping.

**Accessibility:** The tiles are demountable.

**Installation:** Installed according to installation diagrams, installation guides and drawing aid. For information regarding minimum overall depth of system see quantity specification.

**System weight:** Approximate weight of system 2-4 kg/m

**Mechanical properties:** Additional live load has to be fixed to the soffit.

**CE:** Ecophon ceiling systems are CE marked according to the European harmonized standard EN 13964:2014. CE marked construction products are covered by a Declaration of Performance (DOP) which enables customers and users to easily compare performance of products available on the European market.

## Installation diagram in detail [www.ecophon.com](http://www.ecophon.com)

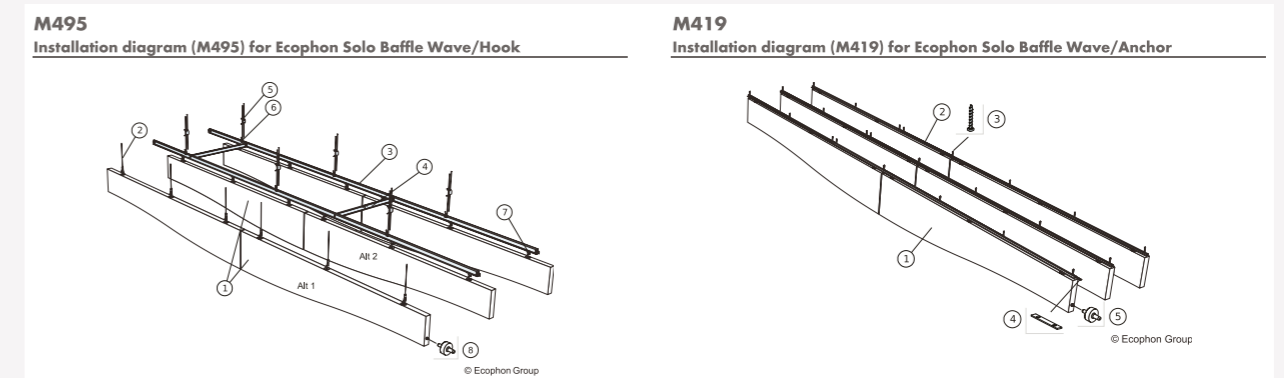

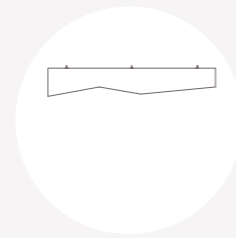

# Ecophon Solo™ Baffle ZigZag

## Acoustic:

### Sound Absorption:

Test results according to EN ISO 354:2003 NOTE: Results shown are not comparable with results according to older versions of this standard due to discrepancies in test method. Classification according to EN ISO 11654, and the single value ratings for Noise Reduction Coefficient, NRC and Sound Absorption Average, SAA according to ASTM C 423.

$\alpha_p$ , Practical sound absorption coefficient

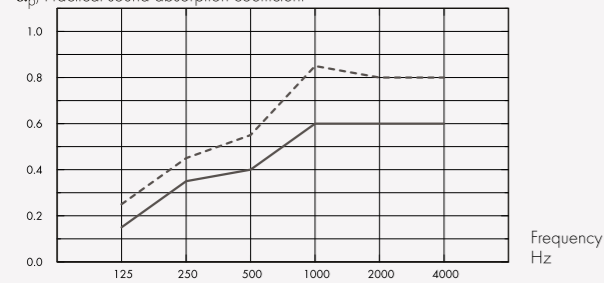

- Solo Baffle ZigZag 1800x300/200, spacing 600, direct mounting
  - Solo Baffle ZigZag 1800x600/300, spacing 600, direct mounting
- o.d.s = overall depth of system

$A_{eq}$ , Equivalent absorption area per unit (m<sup>2</sup> sabin)

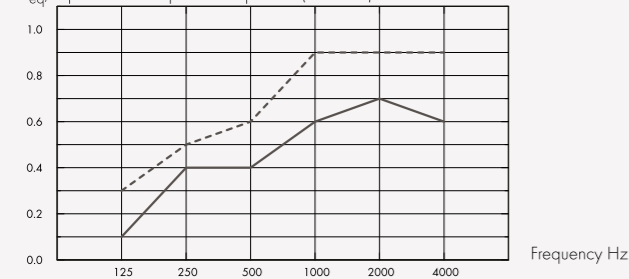

- Solo Baffle ZigZag 1800x300/200
  - Solo Baffle ZigZag 1800x600/300
- o.d.s = overall depth of system

	THK mm	o.d.s. mm	$\alpha_p$ , Practical sound absorption coefficient					$\alpha_w$	
			125 Hz	250 Hz	500 Hz	1000 Hz	2000 Hz		4000 Hz
c600	40	300	0.15	0.35	0.40	0.60	0.60	0.60	0.50
c600	40	600	0.25	0.45	0.55	0.85	0.80	0.80	0.65

	THK mm	o.d.s. mm	$A_{eq}$ , Equivalent absorption area per unit (m <sup>2</sup> sabin)					
			125 Hz	250 Hz	500 Hz	1000 Hz	2000 Hz	4000 Hz
c600	40	300	0.1	0.4	0.4	0.6	0.7	0.6
c600	40	600	0.3	0.5	0.6	0.9	0.9	0.9

	THK mm	o.d.s. mm	NRC	SAA
c600	40	300	0.50	0.49
c600	40	600	0.65	0.65

## Indoor Air Quality:

Certificate / Label	
Eurofins Indoor Air Comfort®	IAC
French VOC	A
Finnish M1	•

**Environmental Footprint:** Solo Baffle ZigZag: 11,13 (Solo Family EPD in conformity with ISO 14025 / EN 15804),

**Circularity:** Minimum post-consumer recycled content: 57%, Recyclability: Fully recyclable,

**Fire safety:** The glass wool core of the tiles is tested and classified as non-combustible according to EN ISO 1182. Europe: EN 13501-1, A2-s1,d0,

**Humidity Resistance:** Class C, relative humidity 95% and 30°C, according to EN 13964:2014

**Visual appearance:** White Frost, nearest NCS colour sample S 0500-N, 85% light reflectance. Gloss < 1.

**Cleanability:** Daily dusting and vacuum cleaning. Weekly wet wiping.

**Accessibility:** The tiles are demountable.

**Installation:** Installed according to installation diagrams, installation guides and drawing aid. For information regarding minimum overall depth of system see quantity specification.

**System weight:** Approximate weight of system 2-4 kg/m

**Mechanical properties:** Additional live load has to be fixed to the soffit.

**CE:** Ecophon ceiling systems are CE marked according to the European harmonized standard EN 13964:2014. CE marked construction products are covered by a Declaration of Performance (DOP) which enables customers and users to easily compare performance of products available on the European market.

## Installation diagram in detail [www.ecophon.com](http://www.ecophon.com)

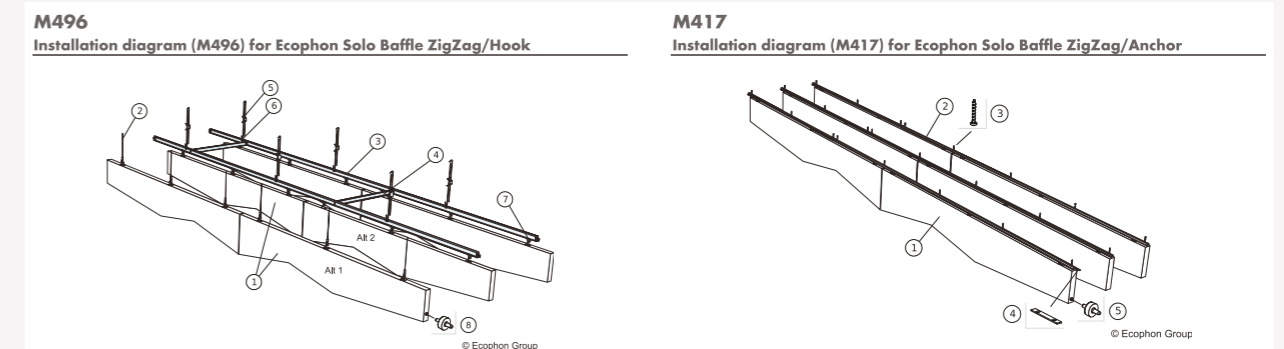



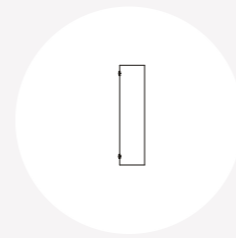

# Ecophon Solo™ Baffle Wall

**Acoustic:** For acoustic data on the Baffle - please see Solo Baffle.

**Indoor Air Quality:**

Certificate / Label	
Eurofins Indoor Air Comfort®	IAC
French VOC	A
Finnish M1	•

**Environmental Footprint:** Solo Baffle Wall: 10,11 (Solo Family EPD in conformity with ISO 14025 / EN 15804),

**Circularity:** Minimum post-consumer recycled content: 57%, Recyclability: Fully recyclable,

**Fire safety:** The glass wool core of the tiles is tested and classified as non-combustible according to EN ISO 1182. Europe: EN 13501-1, A2-s1,d0,

**Humidity Resistance:** Class C, relative humidity 95% and 30°C, according to EN 13964:2014

**Visual appearance:** White Frost, nearest NCS colour sample S 0500-N, 85% light reflectance. Gloss < 1.

**Cleanability:** Daily dusting and vacuum cleaning. Weekly wet wiping.

**Accessibility:** The tiles are demountable.

**Installation:** Installed according to installation diagrams, installation guides and drawing aid. For information regarding minimum overall depth of system see quantity specification.

**Mechanical properties:** Additional live load has to be fixed to the soffit.

**CE:** Ecophon ceiling systems are CE marked according to the European harmonized standard EN13964:2014. CE marked construction products are covered by a Declaration of Performance (DOP) which enables customers and users to easily compare performance of products available on the European market.

## Installation diagram in detail [www.ecophon.com](http://www.ecophon.com)

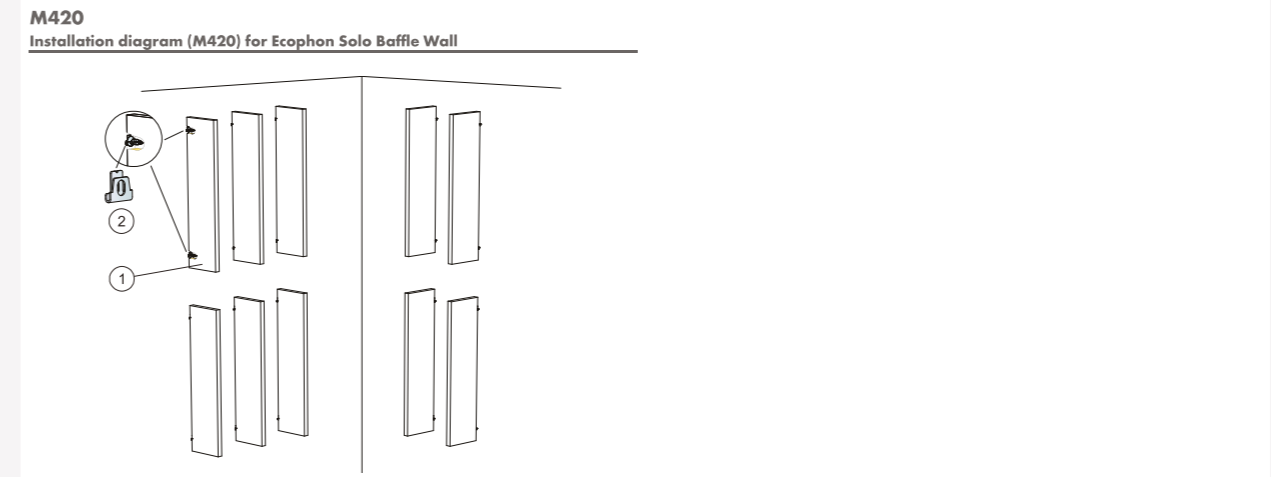

Ecophon is the leading supplier of solutions for indoor acoustic environments that improve working performance, wellbeing and quality of life.

The principles guiding our work are grounded in our Swedish heritage, where a human approach and a common responsibility for people's lives and future challenges come naturally. Ecophon is part of the Saint-Gobain Group, a world leader in sustainable habitat solutions that balance the need for comfort and cost-effectiveness with energy efficiency and environmental responsibility.



– making the world  
a better home.



**Ecophon**<sup>®</sup>  
SAINT-GOBAIN

A SOUND EFFECT ON PEOPLE