

ECOPHON

FOCUS™

A UNIVERSE OF DESIGN FLEXIBILITY



04 ABOUT ECOPHON

06 GOOD ACOUSTICS MATTER EVERYWHERE

08 TOWARDS NET-ZERO ACOUSTICS

10 A UNIVERSE OF DESIGN FLEXIBILITY WITH ECOPHON FOCUS™

12 ECOPHON FOCUS™ PRODUCT RANGE

- 16 Focus A
- 17 Focus B
- 18 Focus Ds
- 20 Focus Dg
- 20 Focus D/A
- 21 Focus E
- 21 Focus Ez
- 22 Focus F
- 22 Focus SQ
- 23 Focus Lp
- 24 Focus Levels
- 25 Focus Flexiform A
- 25 Focus Edge 500
- 26 Focus Fixiform E
- 26 Focus Fixiform Ds
- 27 Focus Frieze
- 27 Focus Wing
- 28 Square 43
- 29 Dot
- 39 Line

30 COLOURS AND SURFACES

32 ECOPHON FOCUS™ OVERVIEW

34 SYSTEM PROPERTIES

Acoustics, technical properties and installation diagrams

Any picture, description, illustration and dimensions contained in this brochure is for information purpose only and is not contractual. This brochure shows Ecophon products and may contain third-party's products. Ecophon shall not be liable for any misprint. Ecophon reserves the right to change product specifications at any time without prior notice. Recommendations of use and installation/assembly, as well as storage, maintenance and indoor environment conditions, must always be respected. Please refer to the applicable technical documentation, such as technical data sheet and installation guidelines. For a comprehensive and up-to-date library of information, including the last version of applicable General Terms and Conditions of Sales, please visit www.ecophon.com

©Saint-Gobain Ecophon AB, 2024-03-05



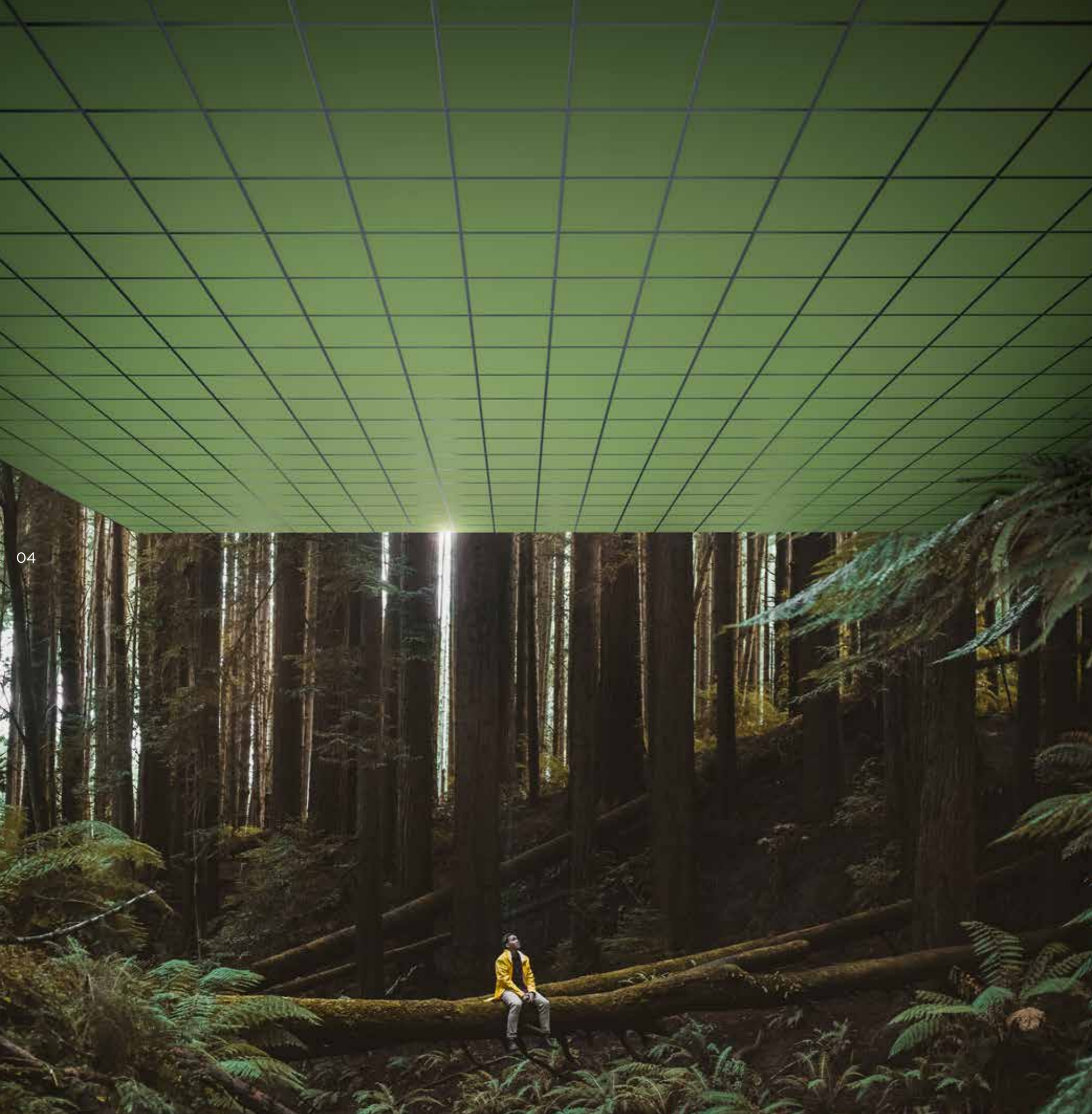

A SOUND EFFECT

ON PEOPLE

Saint-Gobain Ecophon contributes to good indoor environments for working, healing and learning. We do this by developing, manufacturing and delivering acoustic products and systems designed around the natural evolution of human hearing - replicating the outdoor sound experience indoors, because that's just better for people.

Having a sound effect on people, in every way we can, is what we do proudly. That promise makes every one of us a passionate advocate for the importance of room acoustics to people's wellbeing - whatever the space, activity or need.

GOOD ACOUSTICS MATTER EVERYWHERE

06 The importance of acoustics is underappreciated. Sound impacts us in daily life, and the scientific support for improving our indoor sound environments is well-documented.

And what exactly is an ideal indoor sound environment for people? One based on how we experience sound outside. The human auditory sense is naturally adapted to an outdoor environment where there is not any sound reflections from ceilings and walls.

That's why most of what we do at Ecophon is about replicating the acoustic qualities found in nature for indoor environments. We want to optimise indoor spaces to our natural way of hearing, so that speech and sound is easy to hear and understand, when needed, improving performance and wellbeing.

Usually that starts with the ceiling. A wall-to-wall acoustic ceiling is the easiest way to get a large sound-absorbing surface area into a space, and is usually the best way to reduce sound strength, shorten reverberation times, and increase speech clarity and overall hearing comfort.





TOWARDS

NET-ZERO ACOUSTICS

Sustainability is more than a word – it's a collective movement to protect people and the planet that requires honest commitment and genuine care. That's why Ecophon is building on better materials, transparency, and principles, to name just a few.

We actively support an industry-wide drive to standardised, easy-access Environmental Product Declarations for individual products, rather than product families. Their inclusion of full lifecycle data, from raw material sourcing to end of life, rather than only the favourable stages. A move away from self-declared labels, or non-independently verified sustainability claims. And for any promises of net zero carbon emission targets to be validated by the Science-Based Targets initiative.

If we're going to build a sustainable future, it has to start with an honest approach, high ambition and the best of intentions – to build on better together.

ECOPHON FOCUS™

A UNIVERSE OF DESIGN FLEXIBILITY

Ecophon Focus™ is our most comprehensive system family and supports a range of opportunities through different edge designs, forms, levels and installation options.

- Absorption class A
- 11 different edge options in addition to 6 unique solutions
- Premium surface with superior quality and a matte look

Focus is a great choice for cellular offices, corridors, receptions, entrance halls, waiting rooms, team work spaces and other public areas where visual appeal and sound quality are equally important.

The Focus family includes panels that can be fixed directly to soffit. That gives you options for spaces that might seem challenging or impossible to improve acoustically, such as stairwells, basements and spaces with low ceiling height.

Minimum

51%

POST-CONSUMER
RECYCLED CONTENT



Industry low

CO₂

WITH EXCEPTIONAL RAW MATERIALS AND WIDE USE OF RENEWABLE ENERGIES

ECOPHON FOCUS™ PRODUCT RANGE

Focus is suspended wall-to-wall ceilings with excellent acoustic properties, appealing looks and the flexibility to suit every need make the Focus family the perfect toolbox.

The Focus family includes six unique complementary solutions for level changes, wall endings and free-hanging ceilings. They are designed to give the ceiling an integrated appearance that enhances the overall aesthetic appeal.

Focus Levels gives you even more design options. With Levels, you combine a variety of panel thicknesses and sizes to give a ceiling or wall its own uniquely staggered look and feel.

FOCUS A

600x600x20
1200x600x20
1200x1200x20
1600x600x20
1800x600x20
2000x600x20
2400x600x20

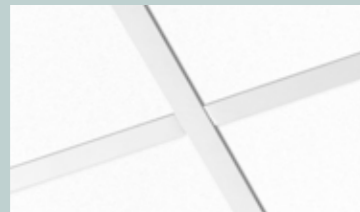

FOCUS B

600x600x20
1200x600x20



FOCUS DS

600x600x20
1200x600x20
1200x1200x20
1600x600x20
1800x600x20
2000x600x20
2400x600x20



FOCUS DG

600x600x20
1200x600x20
1200x1200x25
1600x600x20
1800x600x20
2000x600x20
2400x600x20



FOCUS D/A

1720x600x20
2000x600x20
2400x600x20



FOCUS EZ

600x600x40



FOCUS LP

600x150x20
600x300x20
600x600x20
1200x150x20
1200x300x20
1200x600x20
1800x600x20



FOCUS LEVELS

600x600x20
1200x600x20
1200x300x20
600x600x30
1200x600x30
1200x300x30
600x600x40
1200x600x40
1200x300x40

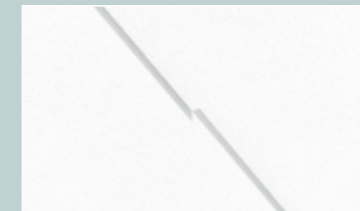

FOCUS E

600x600x20
1200x600x20
1200x1200x20
1600x600x20
1800x600x20
2000x600x20
2400x600x20



FOCUS F

600x600x20
1200x600x20



FOCUS SQ

600x600x20
1200x600x20



FOCUS FLEXIFORM A

1200x600x30
1600x600x30
2000x600x30
2400x600x30



FOCUS FIXIFORM E

1200x600x20



FOCUS FIXIFORM DS

1200x600x20
1500x600x20
1900x600x20
2300x600x20



FOCUS FRIEZE

2400x600x20



FOCUS EDGE 500

600x600x20
1200x600x20
1200x1200x20
1200x1200x25



FOCUS WING

600x200x50
1200x200x50



SQUARE 43

Edge Ds, Dg, E:
600x600x20
Edge Ez:
600x600x40



DOT

Edge Ds, Dg, E:
600x600x20
Edge Ez:
600x600x40



LINE

Edge Lp:
1200x150x20
1200x300x20
Edge Ds, Dg, E:
1200x600x20





FOCUS A
Visible grid system and easy demountable tiles. Available in many formats.

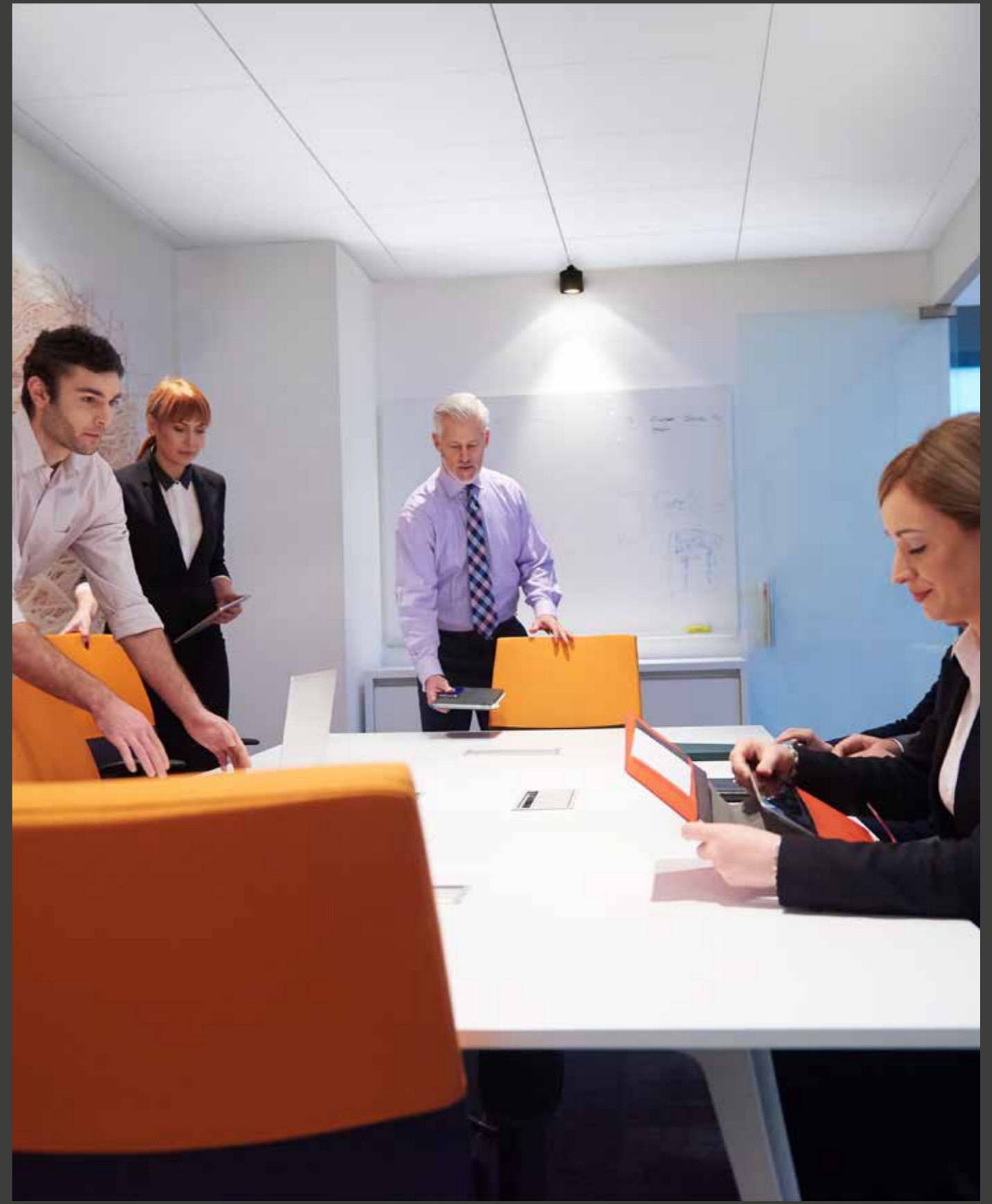
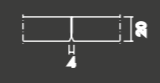

FOCUS B
For direct fixing with glue, ideal for installations that require minimum depth of system.

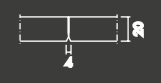



FOCUS Ds
 Bevelled edges that generates a discreet groove between the tiles. Concealed grid system.

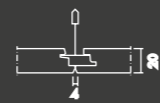



FOCUS Dg

Unique edge design with concealed support edges and a floating appearance.

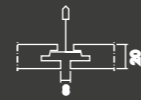

FOCUS E

Recessed visible grid system creating a shadow effect on the edge. Easily demountable tiles.

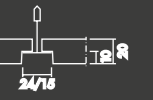

FOCUS D/A

For corridors and bandraaster solutions. Long panels with a concealed grid system.

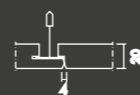

FOCUS Ez

With support edges in different levels enabling a tilted appearance and unique designs.





FOCUS F

For direct fixing with screws, ideal for installations that require minimum depth of system.



FOCUS SQ

For direct fixing with glue. Installed with a gap between each tile.

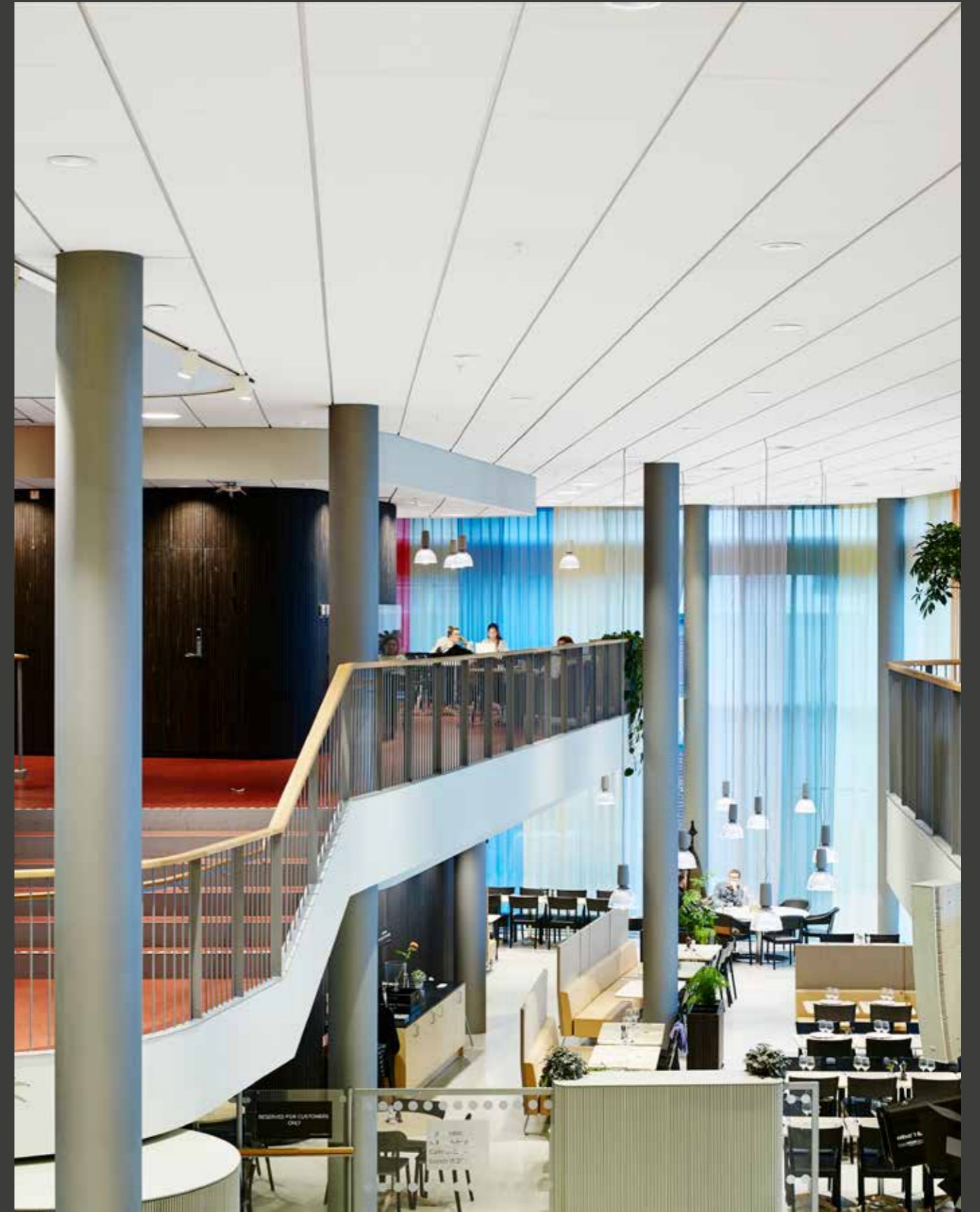

FOCUS Lp

A patented system designed to create long rows in the ceiling, highlighting a specific direction in the room.

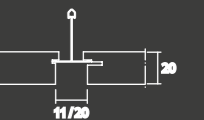



FOCUS LEVELS

Different panel thicknesses within the system for creating unique patterns on walls and ceilings.

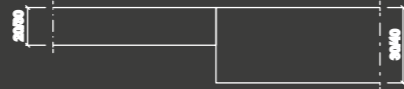

FOCUS FLEXIFORM A

Flexible panels that can be shaped into concave or convex forms.



FOCUS EDGE 500

Edge profile for island installations. Profile in extruded aluminium and corners in cast zinc.





FOCUS FIXIFORM E

Foldable tiles for smooth transitions where there are level shiftings in the ceiling.

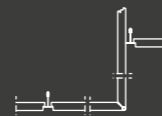

FOCUS FRIEZE

End panels for creating a smooth transition between the ceiling and the wall.

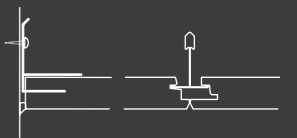

FOCUS FIXIFORM Ds

Foldable tiles for smooth transitions where there are level shiftings in the ceiling.

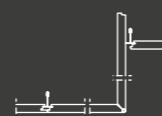

FOCUS WING

Wing shaped absorbers for free-hanging suspended ceilings.

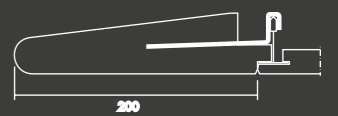



SQUARE 43
Great lighting comfort and low UGR value.

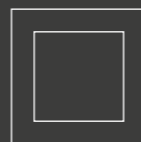

DOT
Great lighting comfort and low UGR value.

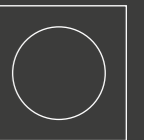

LINE
The luminaire has great lighting comfort and adds a distinct direction to the ceiling.



GRID COLOURS - CREATE YOUR OWN DESIGN

An acoustic ceiling is often the largest continuous surface in a room. It will affect not only the entire look and feel of the interior, but also the end-users' wellbeing.

- 18 colour options for grids
- Closest Akutex FT match creates subtile pattern and mixing FT colours gives more design effect

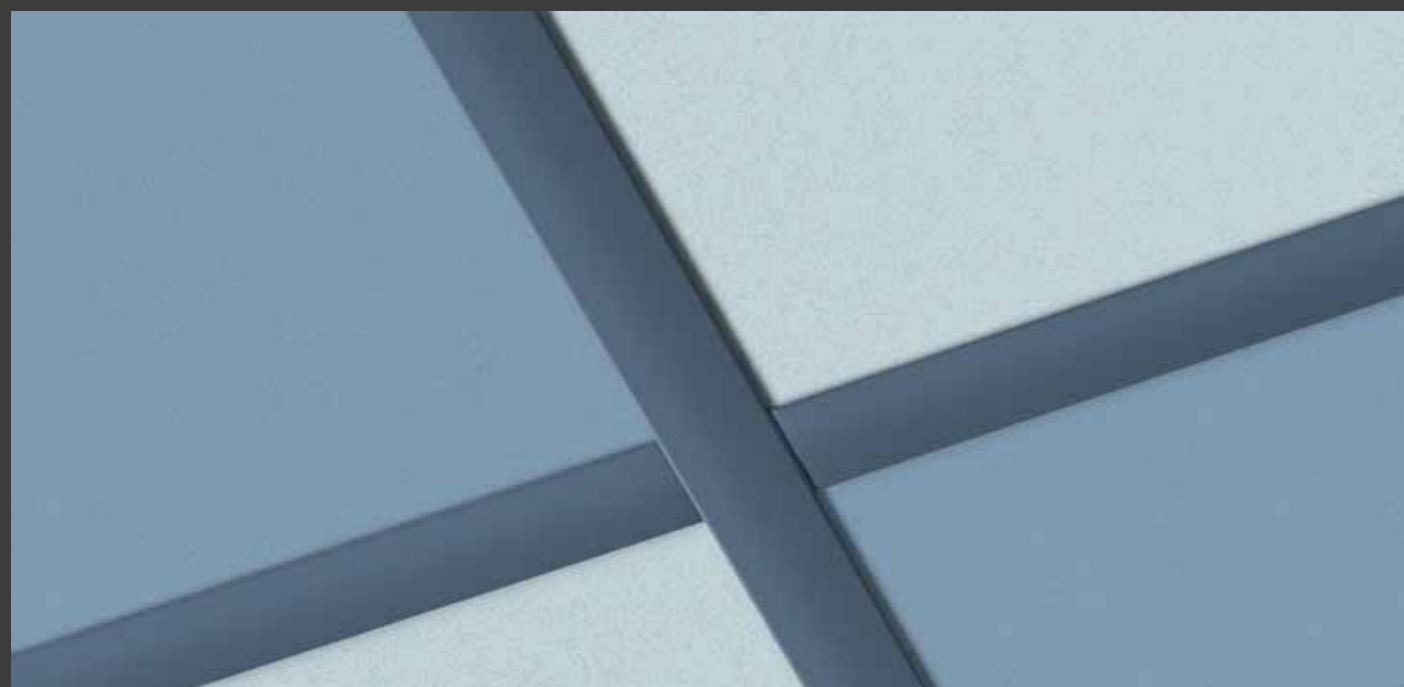
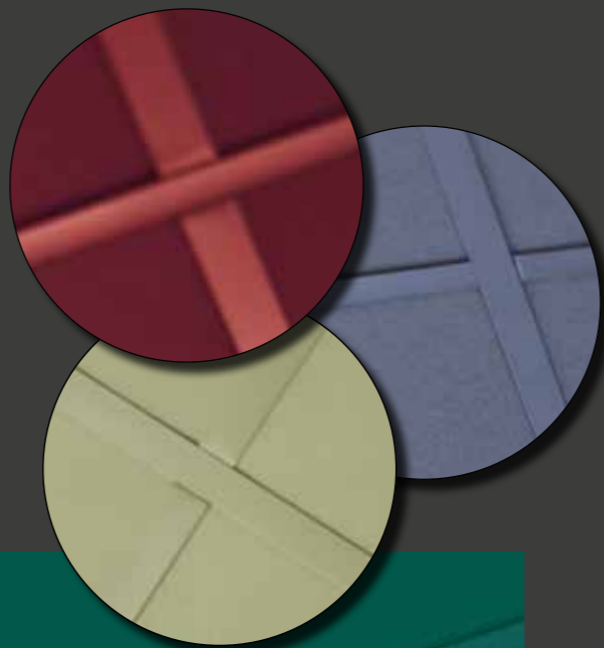

COLOURS AND SURFACES

AKUTEX™ FT

The Akutex label guarantees that the product carrying it has a superior surface technology. Our research and development will always focus on visual aspects, acoustic properties, working environment, architectural trends and environmental aspects. This ensures that Akutex is always one step ahead.



WHITE FROST
Nearest NCS colour sample S 0500-N.
Light reflectance 85%.



VOLCANIC ASH
Nearest NCS colour sample 2002-Y.
Light reflectance 56%.



SILVER STONE
Nearest NCS colour sample S 4502-Y.
Light reflectance 29%.

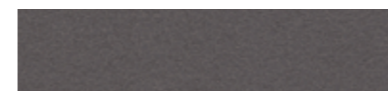

SILK SLATE
Nearest NCS colour sample S 7000-N.
Light reflectance 13%.



GOJI BERRY
Nearest NCS colour sample S 3030-Y80R.
Light reflectance 27%.



SILENT STEAM
Nearest NCS colour sample S 2010-B.
Light reflectance 45%.

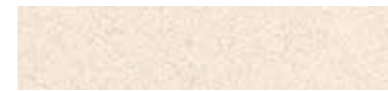

SCALLOP SHELLS
Nearest NCS colour sample S 0804-Y50R.
Light reflectance 76%.



WET SAND
Nearest NCS colour sample S 3020-Y30R.
Light reflectance 35%.



OCEAN STORM
Nearest NCS colour sample S 4020-R90B.
Light reflectance 24%.



MOONLIGHT SKY
Nearest NCS colour sample S 7020-R90B.
Light reflectance 7%.



GOLDEN FIELD
Nearest NCS colour sample S 1040-G90Y.
Light reflectance 61%.



SUNSET HEAT
Nearest NCS colour sample S 2070-Y60R.
Light reflectance 20%.



RUBY ROCK
Nearest NCS colour sample S 4050-R10B.
Light reflectance 7%.



EUCALYPTUS LEAF
Nearest NCS colour sample S 5010-B30G.
Light reflectance 23%.



SUMMER FOREST
Nearest NCS colour sample S 6030-G10Y.
Light reflectance 10%.



DARK DIAMOND
Nearest NCS colour sample S 9000-N.
Light reflectance 4%.



MORNING DRIZZLE
Nearest NCS colour sample S 1002-B.
Light reflectance 69%.



CLOUDY DAY
Nearest NCS colour sample S 1500-N.
Light reflectance 62%.



PEACH ROSE
Nearest NCS colour sample S 1515-Y80R.
Light reflectance 55%.



HIGHLAND FOG
Nearest NCS colour sample S 2005-G.
Light reflectance 55%.



SAGE GARDEN
Nearest NCS colour sample S 3010-B30G.
Light reflectance 40%.



FRESH CLOVER
Nearest NCS colour sample S 3020-G40Y.
Light reflectance 35%.

NOTE
Colours may vary slightly between different production batches.
Reproduction of colours vary between print and reality.

ECOPHON FOCUS OVERVIEW

EDGE DESIGN	PRODUCT	ABSORPTION CLASS	CONNECT GRID	SIZES (MM)	ECOPHON LIGHTING	POSSIBLE COMBINATIONS
	Ecophon Focus A	A	T15/ T24	600x600x20, 1200x600x20, 1200x1200x20, 1600x600x20, 1800x600x20, 2000x600x20, 2400x600x20		Ecophon Focus Flexiform A Ecophon Focus Frieze
	Ecophon Focus B	C	Direct fixing	600x600x20 1200x600x20		
	Ecophon Focus Ds	A	T24	600x600x20, 1200x600x20, 1200x1200x20, 1600x600x20, 1800x600x20, 2000x600x20, 2400x600x20	Ecophon Dot Ecophon Square 43 Ecophon Line	Ecophon Focus Edge 500 Ecophon Focus Fixiform Ds Ecophon Focus Frieze Ecophon Focus Wing
	Ecophon Focus Dg	A	T24	600x600x20, 1200x600x20, 1200x1200x25, 1600x600x20, 1800x600x20, 2000x600x20, 2400x600x20	Ecophon Dot Ecophon Square 43 Ecophon Line	Ecophon Focus Edge 500 Ecophon Focus Frieze
	Ecophon Focus D/A	A	T24 Bandraaster	1720x600x20, 2000x600x20, 2400x600x20		
	Ecophon Focus E	A	T15/ T24	600x600x20, 1200x600x20, 1200x1200x20, 1600x600x20, 1800x600x20, 2000x600x20, 2400x600x20	Ecophon Dot Ecophon Square 43 Ecophon Line	Ecophon Focus Edge 500 Ecophon Focus Fixiform E Ecophon Focus Frieze Ecophon Focus Wing
	Ecophon Focus Ez	A	T24	600x600x40	Ecophon Dot Ecophon Square 43	
	Ecophon Focus F	C	Direct fixing	600x600x20, 1200x600x20		
	Ecophon Focus Lp	A	T24	600x150x20, 600x300x20, 600x600x20 1200x150x20, 1200x300x20, 1200x600x20 1800x600x20	Ecophon Line	
	Ecophon Focus SQ	C	Direct fixing	600x600x20, 1200x600x20		
	Ecophon Focus Levels	Up to A	Direct fixing, ceiling and wall	600x600x20, 1200x600x20, 1200x300x20, 600x600x30, 1200x600x30, 1200x300x30, 600x600x40, 1200x600x40, 1200x300x40		
	Ecophon Focus Flexiform A	A	T24	1200x600x30, 1600x600x30, 2000x600x30, 2400x600x30		Ecophon Focus A
	Ecophon Focus Fixiform E	A	T24	1200x600x20		Ecophon Focus E
	Ecophon Focus Fixiform Ds	A	T24	1200x600x20, 1500x600x20, 1900x600x20, 2300x600x20		Ecophon Focus Ds
	Ecophon Focus Frieze	A	T24	2400x600x20		Ecophon Focus A Ecophon Focus Ds Ecophon Focus Dg Ecophon Focus E
	Ecophon Focus Edge 500		T24	600x600x20, 1200x600x20, 1200x1200x20 1200x1200x25		Ecophon Focus Ds Ecophon Focus Dg Ecophon Focus E
	Ecophon Focus Wing	A	T24	600x200x50, 1200x200x50		Ecophon Focus Ds Ecophon Focus E



Ecophon Focus panels contribute to a healthy indoor environment with superior acoustic absorption, low VOC emissions in line with the strictest requirements, and a full chemical transparency with verified C2C Material Health Certificate. The low carbon footprint of our Focus panels is third-party verified in Environmental Product Declarations.

The products do not contribute to fire and the glass wool core of the Focus tiles is tested and classified as non-combustible according to EN ISO 1182. Fire classification according to EN 13501-1, see Technical Properties on respectively product.

NOTE
More product and system information such as installation help and sustainability documentation can be found at www.ecophon.com

SYSTEM

PROPERTIES

ACOUSTICS, TECHNICAL PROPERTIES AND INSTALLATION DIAGRAMS

36	Focus A
39	Focus B
41	Focus Ds
46	Focus Dg
48	Focus D/A
50	Focus E
52	Focus Ez
54	Focus F
56	Focus Lp
58	Focus SQ
60	Focus Levels
62	Focus Flexiform A
64	Focus Edge 500
65	Focus Fixiform E
67	Focus Fixiform Ds
69	Focus Frieze
71	Focus Wing
72	Square 43
73	Dot
74	Line

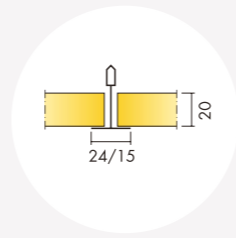

Ecophon Focus™ A

Acoustic:

Sound Absorption:

Test results according to EN ISO 354. Classification according to EN ISO 11654, and the single value ratings for Noise Reduction Coefficient, NRC and Sound Absorption Average, SAA according to ASTM C 423.

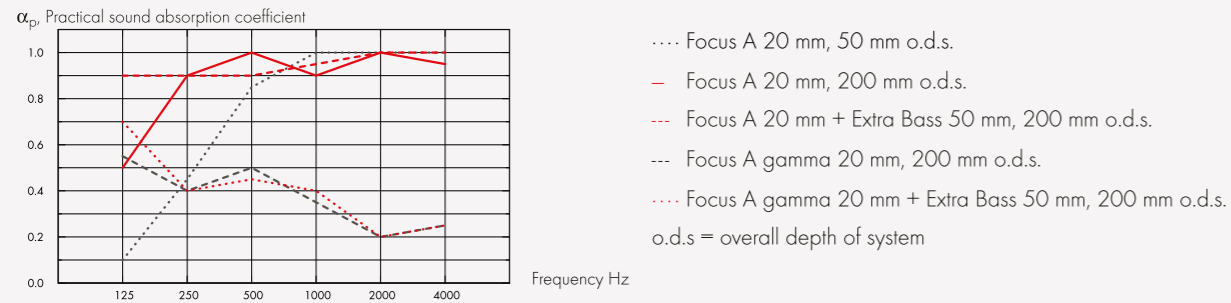

	THK mm	o.d.s. mm	α_p , Practical sound absorption coefficient						α_w	Sound absorption class
			125 Hz	250 Hz	500 Hz	1000 Hz	2000 Hz	4000 Hz		
-	20	50	0.10	0.45	0.85	1.00	1.00	1.00	0.75	C
-	20	200	0.50	0.90	1.00	0.90	1.00	0.95	1.00	A
+ Extra Bass,	70	200	0.90	0.90	0.90	0.95	1.00	1.00	0.95	A
gamma	20	200	0.55	0.40	0.50	0.35	0.20	0.25	0.30	D
gamma + Extra Bass	70	200	0.70	0.40	0.45	0.40	0.20	0.25	0.30	D

	THK mm	o.d.s. mm	NRC	SAA
-	20	50	0.85	0.83
-	20	200	0.95	0.93
+ Extra Bass,	70	200	0.93	0.93
gamma	20	200	0.35	0.36
gamma + Extra Bass	70	200	0.35	0.37
-	20	400	0.85	0.88

THK mm	AC(1.5) Articulation Class, ASTM E1111, ASTM E1110	D_{nfw} Weighted normalized flanking level difference, ISO 10848-2	CAC dB Ceiling Attenuation Class, ASTM 1414, ASTM E413
20	190	20	21

Indoor Air Quality:

Certificate / Label	Standard	Plant
Eurofins Indoor Air Comfort®	IAC	IAC Gold
French VOC	A	A+
Finnish M1	•	•

Environmental Footprint: Life-cycle stages A1 to C4 from EPD, in conformity with ISO 14025 / EN 15804

	kg CO ₂ equiv/m ²
Focus A	2,6 (Focus family EPD in conformity with ISO 14025 / EN 15804)
Focus A/Plant	1,81 (Focus A/Plant EPD in conformity with ISO 14025 / EN 15804)

Circularity: Minimum post-consumer recycled content: 51%, Recyclability: Fully recyclable,

Fire safety: The glass wool core of the tiles is tested and classified as non-combustible according to EN ISO 1182. Europe: EN 13501-1, A2-s1,d0,

Humidity Resistance: According to EN 13964:2014 Standard: Class C, RH 95% and 30°C, Plant: Class A, RH 70% and 25°C,

Visual appearance: White Frost, nearest NCS colour sample S 0500-N, 85% light reflectance. Gloss < 1.

Cleanability: Daily dusting and vacuum cleaning. Weekly wet wiping.

Accessibility: The tiles are easily demountable. Minimum demounting depth according to installation diagrams.

Installation: Installed according to installation diagrams, installation guides and drawing aid. For information regarding minimum overall depth of system see quantity specification.

System weight: The weight of the system (including suspension grid) should be approximately 3 kg/m².

Mechanical properties: See table about Max live load and Min load bearing capacity and Functional demands, Mechanical properties at www.ecophon.com.

CE: Ecophon ceiling systems are CE marked according to the European harmonized standard EN13964:2014. CE marked construction products are covered by a Declaration of Performance (DOP) which enables customers and users to easily compare performance of products available on the European market.

Installation diagram in detail www.ecophon.com

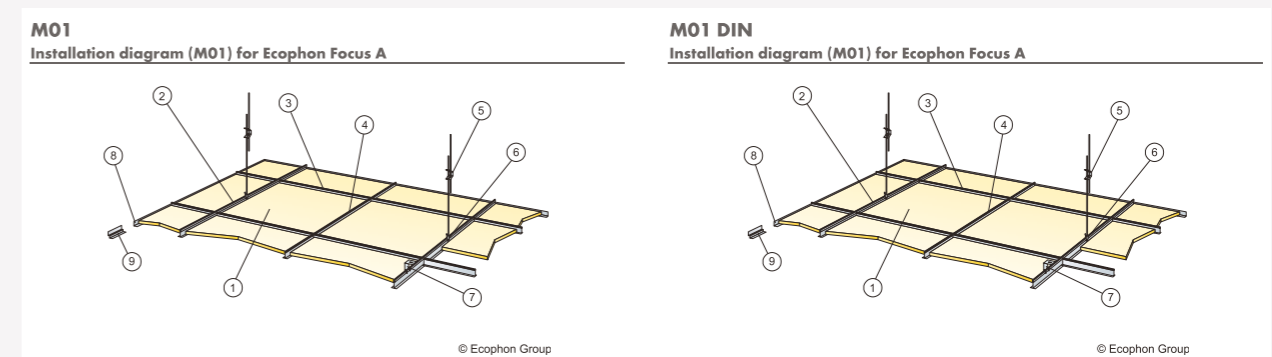

M16
Installation diagram (M16) for Ecophon Focus A XL in corridors

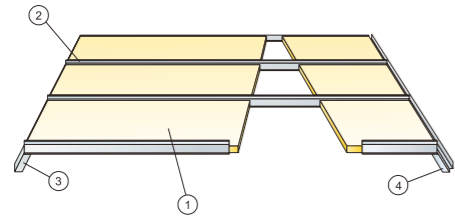

© Ecophon Group

M46
Installation diagram (M46) for Ecophon Focus A XL

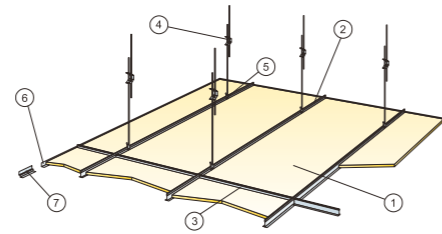

© Ecophon Group

M399
Installation diagram (M399) for Ecophon Focus A

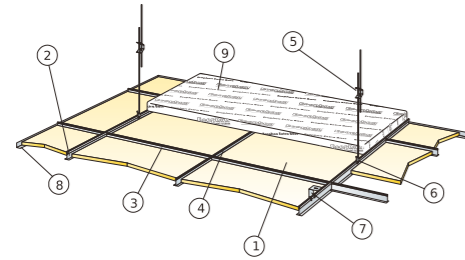

© Ecophon Group

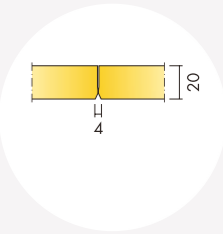

Ecophon Focus™ B

Acoustic:

Sound Absorption:

Test results according to EN ISO 354. Classification according to EN ISO 11654, and the single value ratings for Noise Reduction Coefficient, NRC and Sound Absorption Average, SAA according to ASTM C 423.

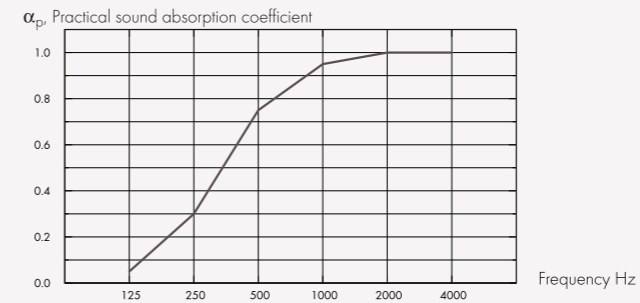

– Focus B 20 mm, 23 mm o.d.s.
o.d.s = overall depth of system

THK mm	o.d.s. mm	α_p , Practical sound absorption coefficient					α_w	Sound absorption class	
		125 Hz	250 Hz	500 Hz	1000 Hz	2000 Hz			4000 Hz
20	23	0.05	0.30	0.75	0.95	1.00	1.00	0.60	C

THK mm	o.d.s. mm	NRC	SAA
20	23	0.75	0.76

Indoor Air Quality:

Certificate / Label	Rating
Eurofins Indoor Air Comfort®	IAC
French VOC	A
Finnish M1	•

Environmental Footprint: Life-cycle stages A1 to C4 from EPD, in conformity with ISO 14025 / EN 15804

	kg CO ₂ equiv/m ²
Focus B	4,10

Circularity: Minimum post-consumer recycled content: 56%, Recyclability: Fully recyclable,

Fire safety: The glass wool core of the tiles is tested and classified as non-combustible according to EN ISO 1182. Europe: EN 13501-1, A2-s1,d0,

Humidity Resistance: Class C, relative humidity 95% and 30°C, according to EN 13964:2014

Visual appearance: White Frost, nearest NCS colour sample S 0500-N, 85% light reflectance. Gloss < 1.

Cleanability: Daily dusting and vacuum cleaning. Weekly wet wiping.

Accessibility: The tiles are not demountable.

Installation: Installed according to installation diagrams, installation guides and drawing aid. For information regarding minimum overall depth of system see quantity specification. Rendered surfaces must have sufficient strength to be able to carry the load imposed by the tiles. If doubts, test gluing should be carried out. The surface should always be dry and clean. For best result the surface should be even.

System weight: The weight of the system should be approximately 2,5 kg/m²

Mechanical properties: Additional live load has to be fixed to the soffit.

CE: Ecophon ceiling systems are CE marked according to the European harmonized standard EN13964:2014. CE marked construction products are covered by a Declaration of Performance (DOP) which enables customers and users to easily compare performance of products available on the European market.

Installation diagram in detail www.ecophon.com

M03
Installation diagram (M03) for Ecophon Focus B, using Connect Absorber glue

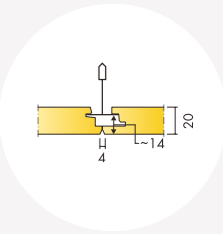
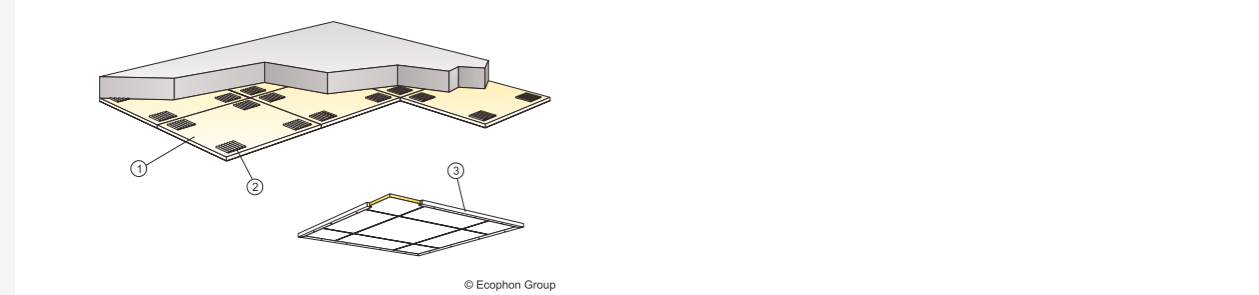

Ecophon Focus™ Ds

Acoustics:

Sound Absorption:

Test results according to EN ISO 354. Classification according to EN ISO 11654, and the single value ratings for Noise Reduction Coefficient, NRC and Sound Absorption Average, SAA according to ASTM C 423.

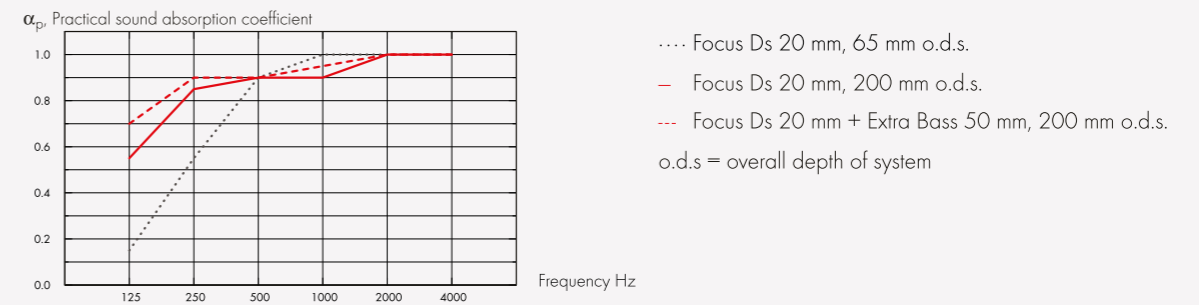

	THK mm	o.d.s. mm	α_p Practical sound absorption coefficient						α_w	Sound absorption class
			125 Hz	250 Hz	500 Hz	1000 Hz	2000 Hz	4000 Hz		
-	20	65	0.15	0.55	0.90	1.00	1.00	1.00	0.85	B
-	20	200	0.55	0.85	0.90	0.90	1.00	1.00	0.95	A
+ Extra Bass	70	200	0.70	0.90	0.90	0.95	1.00	1.00	0.95	A

	THK mm	o.d.s. mm	NRC	SAA
-	20	65	0.85	0.86
-	20	200	0.90	0.93
+ Extra Bass	70	200	0.95	0.95

THK mm	AC(1.5) Articulation Class, ASTM E1111, ASTM E1110	D_{nfw} Weighted normalized flanking level difference, ISO 10848-2	CAC dB Ceiling Attenuation Class, ASTM 1414, ASTM E413
20	180	24	23

Indoor Air Quality:

Certificate / Label	All Products
Eurofins Indoor Air Comfort®	IAC Gold
French VOC	A+
Finnish M1	•

Indoor Air Quality:

Certificate / Label	6x6, 12x6 White Frost/Dark Diamond - 12x12 White Frost	Other formats
Eurofins Indoor Air Comfort®	IAC Gold	IAC Gold
French VOC	A+	A+
Finnish M1		•

Indoor Air Quality: In collaboration with the Allergy, Skin and Asthma Association

Cradle to Cradle Certified®: This product is Cradle to Cradle Certified® at Bronze level (version 4.0).

Material Health: This product has received a C2C Certified Material Health Certificate™ at the Silver level (standard version 4.0). The C2C Certified Material Health Certificate™ is a verification of the health and safety of a product's composition using the Material Health requirements of the Cradle-to-Cradle Certified Product Standard.

Environmental Footprint: Life-cycle stages A1 to C4 from EPD, in conformity with ISO 14025 / EN 15804

	kg CO ₂ equiv/m ²
Focus Ds (EN 15804+A2)	3,70

Circularity: Minimum post-consumer recycled content: 54%, Recyclability: Fully recyclable,

Circularity: Minimum post-consumer recycled content: 54%, Recyclability: Fully recyclable,

Fire safety: The glass wool core of the tiles is tested and classified as non-combustible according to EN ISO 1182. Europe: EN 13501-1, A2-s1,d0,

Humidity Resistance: Class C, relative humidity 95% and 30°C, according to EN 13964:2014

Visual appearance: White Frost, nearest NCS colour sample S 0500-N, 85% light reflectance. Gloss < 1.

Cleanability: Daily dusting and vacuum cleaning. Weekly wet wiping.

Accessibility: The tiles in size 600x600 and 1200x600 are easily demountable. The tiles in size 1200x1200 and XL sizes are demountable. Minimum demounting depth according to installation diagrams.

Installation: Installed according to installation diagrams, installation guides and drawing aid. For information regarding minimum overall depth of system see quantity specification. The systems are not recommended for small rooms (approximately 2x2 m²). Ceilings with a large amount of integrations require careful planning, design and installation.

System weight: The weight of the system (including suspension grid) should be approximately 3kg/m² and 4,5kg/m² with Extra Bass

Mechanical properties: See table about Max live load and Min load bearing capacity and Functional demands, Mechanical properties at www.ecophon.com.

CE: Ecophon ceiling systems are CE marked according to the European harmonized standard EN13964:2014. CE marked construction products are covered by a Declaration of Performance (DOP) which enables customers and users to easily compare performance of products available on the European market.

Installation diagram in detail www.ecophon.com

M581
Installation diagram (M581) for Ecophon Focus Ds 600x600, 1200x600 mm and Ecophon Focus Ds XL. Suspended installation

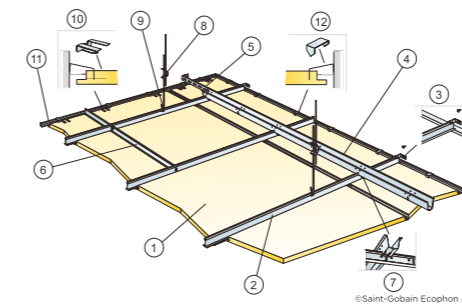

M581DIN
Installation diagram (M581DIN) for Ecophon Focus Ds 625x625, 1250x625 mm. Suspended installation

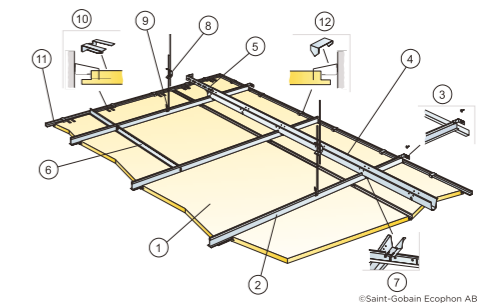

M582
Installation diagram (M582) for Ecophon Focus Ds 1200x1200 mm. Suspended installation

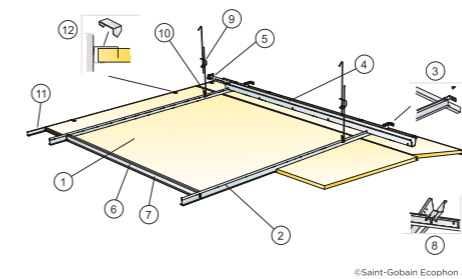

M583
Installation diagram (M583) for Ecophon Focus Ds 600x600, 1200x600 mm. Suspended installation

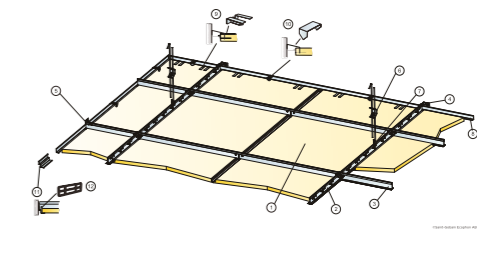

M583DIN
Installation diagram (M583DIN) for Ecophon Focus Ds 625x625, 1250x625 mm. Suspended installation

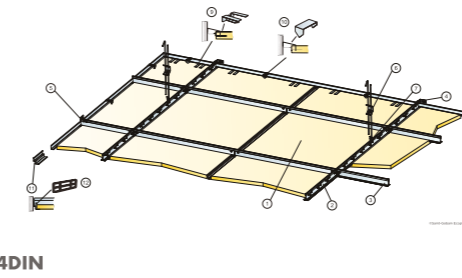

M584
Installation diagram (M584) for Ecophon Focus Ds 600x600, 1200x600 mm. Direct installation

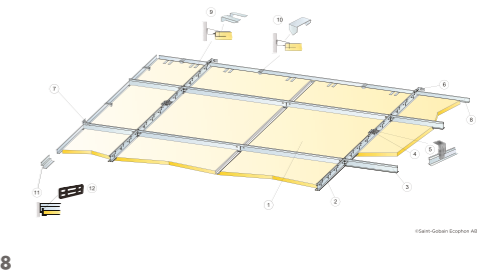

M584DIN
Installation diagram (M584DIN) for Ecophon Focus Ds 625x625, 1250x625 mm. Direct installation

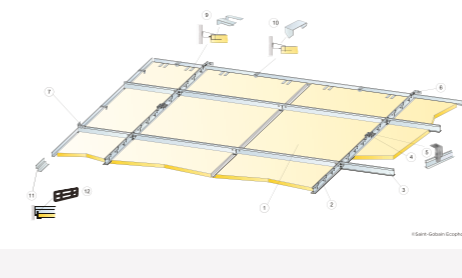

M238
Installation diagram (M238) for Ecophon Focus Ds XL in corridors

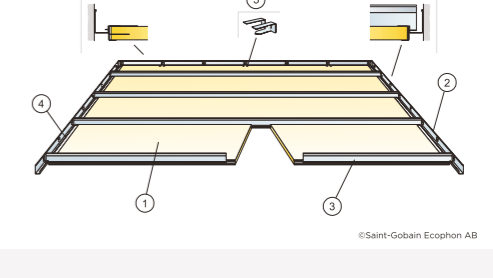

M613
Installation diagram (M613) for Ecophon Focus Ds Level change. Suspended installation

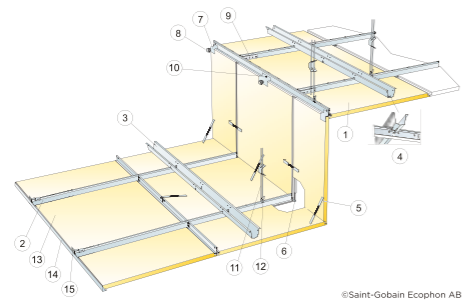

©Saint-Gobain Ecophon AB

M614
Installation diagram (M614) for Ecophon Focus Ds. Suspended installation

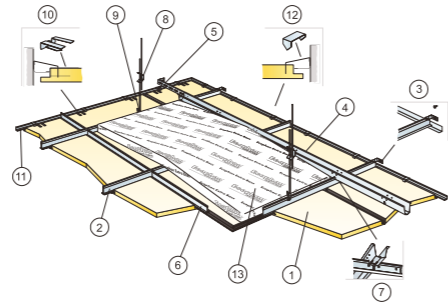

©Saint-Gobain Ecophon AB



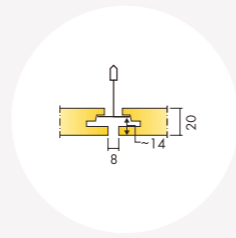

Ecophon Focus™ Dg

Acoustic:

Sound Absorption:

Test results according to EN ISO 354. Classification according to EN ISO 11654, and the single value ratings for Noise Reduction Coefficient, NRC and Sound Absorption Average, SAA according to ASTM C 423.

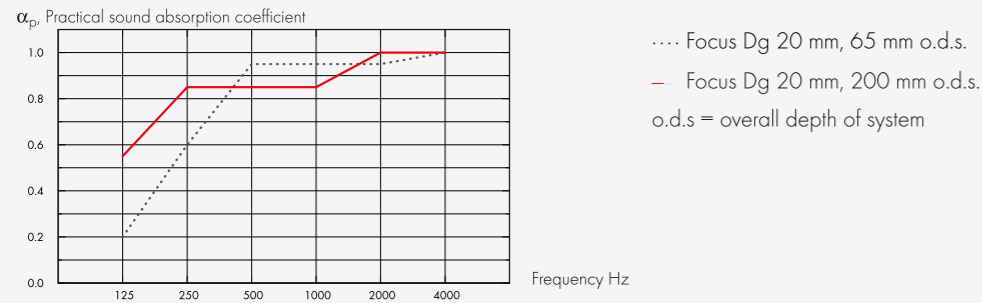

THK mm	o.d.s. mm	α_p , Practical sound absorption coefficient						α_w	Sound absorption class
		125 Hz	250 Hz	500 Hz	1000 Hz	2000 Hz	4000 Hz		
20	65	0.20	0.60	0.95	0.95	0.95	1.00	0.90	A
20	200	0.55	0.85	0.85	0.85	1.00	1.00	0.90	A

THK mm	o.d.s. mm	NRC	SAA
20	65	0.90	0.89
20	400	0.80	0.82

THK mm	Articulation Class, ASTM E1111, ASTM E1110
20	AC(1.5) 180

Indoor Air Quality:

Certificate / Label	
Eurofins Indoor Air Comfort®	IAC
French VOC	A
Finnish M1	•

Environmental Footprint: Life-cycle stages A1 to C4 from EPD, in conformity with ISO 14025 / EN 15804

	kg CO ₂ equiv/m ²
Focus Dg	4,20

Circularity: Minimum post-consumer recycled content: 59%, Recyclability: Fully recyclable,

Fire safety: The glass wool core of the tiles is tested and classified as non-combustible according to EN ISO 1182. Europe: EN 13501-1, A2-s1,d0,

Humidity Resistance: Class C, relative humidity 95% and 30°C, according to EN 13964:2014

Visual appearance: White Frost, nearest NCS colour sample S 0500-N, 85% light reflectance. Gloss < 1.

Cleanability: Daily dusting and vacuum cleaning. Weekly wet wiping.

Accessibility: The tiles in size 600x600 and 1200x600 are easily demountable. The tiles in size 1200x1200 and XL sizes are demountable. Minimum demounting depth according to installation diagrams.

Installation: Installed according to installation diagrams, installation guides and drawing aid. For information regarding minimum overall depth of system see quantity specification. The systems are not recommended for small rooms (approximately 2x2 m²). Ceilings with a large amount of integrations require careful planning, design and installation.

System weight: The weight of the system (including suspension grid) should be approximately 3-4 kg/m².

Mechanical properties: See table about Max live load and Min load bearing capacity and Functional demands, Mechanical properties at www.ecophon.com.

CE: Ecophon ceiling systems are CE marked according to the European harmonized standard EN13964:2014. CE marked construction products are covered by a Declaration of Performance (DOP) which enables customers and users to easily compare performance of products available on the European market.

Installation diagram in detail www.ecophon.com

M202
Installation diagram (M202) for Ecophon Focus Dg 600x600, 1200x600 mm

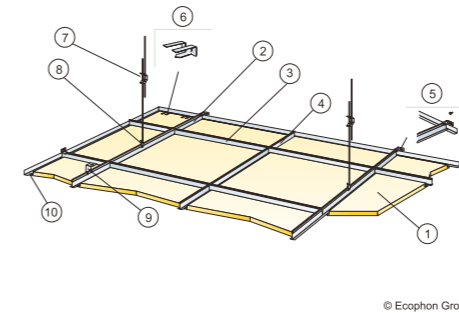

M203
Installation diagram (M203) for Ecophon Focus Dg 1200x1200 mm

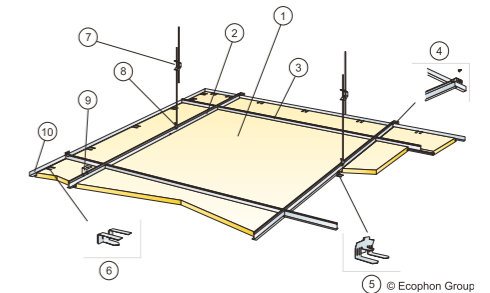

M204
Installation diagram (M204) for Ecophon Focus Dg XL

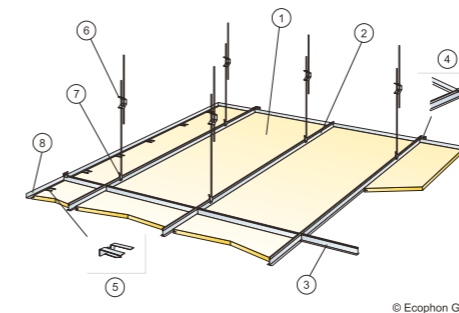

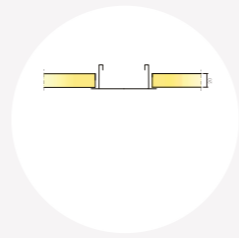

Ecophon Focus™ D/A

Acoustic:

Sound Absorption:

Test results according to EN ISO 354. Classification according to EN ISO 11654, and the single value ratings for Noise Reduction Coefficient, NRC and Sound Absorption Average, SAA according to ASTM C 423.

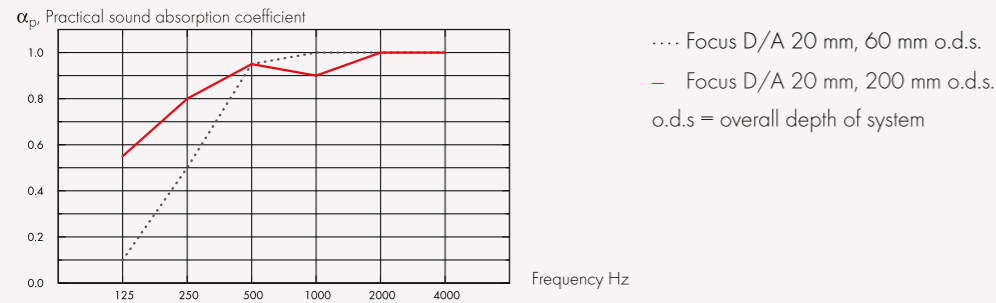

THK mm	o.d.s. mm	α_p , Practical sound absorption coefficient						α_w	Sound absorption class
		125 Hz	250 Hz	500 Hz	1000 Hz	2000 Hz	4000 Hz		
20	60	0.10	0.50	0.95	1.00	1.00	1.00	0.80	A
20	200	0.55	0.80	0.95	0.90	1.00	1.00	0.95	A

	THK mm	o.d.s. mm	NRC	SAA
-	20	60	0.90	0.89
-	20	400	0.80	0.82

THK mm	AC(1.5)		D_{ntw}	CAC dB	
	Articulation Class, ASTM E1111, ASTM E1110			Ceiling Attenuation Class, ASTM 1414, ASTM E413	
20	180		24	25	

Indoor Air Quality:

Certificate / Label	
Eurofins Indoor Air Comfort®	IAC
French VOC	A
Finnish M1	•

Environmental Footprint: Life-cycle stages A1 to C4 from EPD, in conformity with ISO 14025 / EN 15804

	kg CO ₂ equiv/m ²
Focus DA	4,32

Circularity: Minimum post-consumer recycled content: 57%, Recyclability: Fully recyclable,

Fire safety: The glass wool core of the tiles is tested and classified as non-combustible according to EN ISO 1182. Europe: EN 13501-1, A2-s1,d0,

Humidity Resistance: Class C, relative humidity 95% and 30°C, according to EN 13964:2014

Visual appearance: White Frost, nearest NCS colour sample S 0500-N, 85% light reflectance. Gloss < 1.

Cleanability: Daily dusting and vacuum cleaning. Weekly wet wiping.

Accessibility: The tiles are easily demountable. Minimum demounting depth according to installation diagrams.

Installation: Installed according to installation diagram and bandraster/grid supplier recommendations.

System weight: The weight of the system (including suspension grid) should be approximately 2 kg/m².

Mechanical properties: See table about Max live load and Min load bearing capacity and Functional demands, Mechanical properties at www.ecophon.com.

CE: Ecophon ceiling systems are CE marked according to the European harmonized standard EN13964:2014. CE marked construction products are covered by a Declaration of Performance (DOP) which enables customers and users to easily compare performance of products available on the European market.

Installation diagram in detail www.ecophon.com

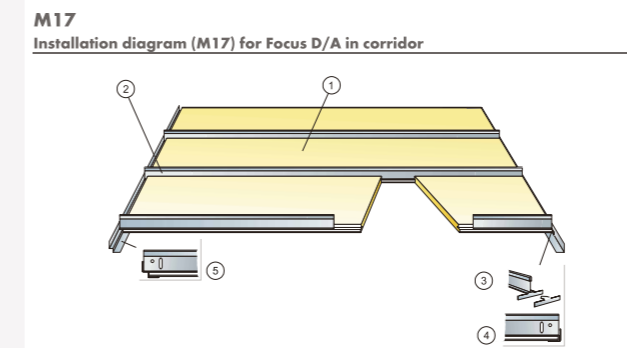

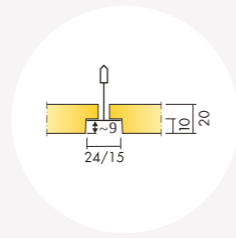

Ecophon Focus™ E

Acoustic:

Sound Absorption:

Test results according to EN ISO 354. Classification according to EN ISO 11654, and the single value ratings for Noise Reduction Coefficient, NRC and Sound Absorption Average, SAA according to ASTM C 423.

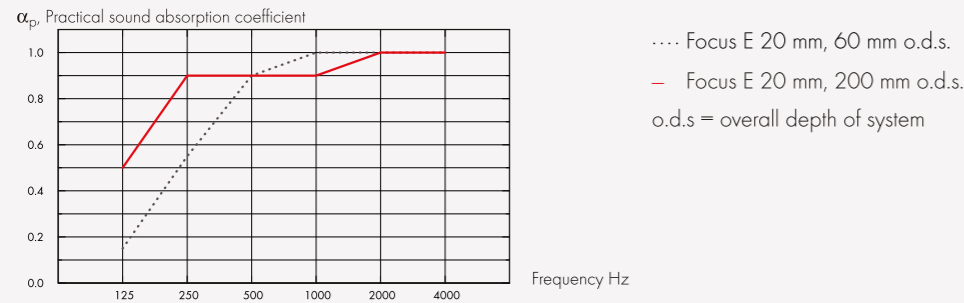

THK mm	o.d.s. mm	α_p , Practical sound absorption coefficient						α_w	Sound absorption class
		125 Hz	250 Hz	500 Hz	1000 Hz	2000 Hz	4000 Hz		
20	60	0.15	0.55	0.90	1.00	1.00	1.00	0.85	B
20	200	0.50	0.90	0.90	0.90	1.00	1.00	0.95	A

	THK mm	o.d.s. mm	NRC	SAA
-	20	60	0.90	0.87
-	20	400	0.85	0.85

THK mm	AC(1.5)		D_{ntw}	CAC dB	
	Articulation Class, ASTM E1111, ASTM E1110			Ceiling Attenuation Class, ASTM 1414, ASTM E413	
20	180		22	23	

Indoor Air Quality:

Certificate / Label	Plant
Eurofins Indoor Air Comfort®	IAC IAC Gold
French VOC	A A+
Finnish M1	• •

Environmental Footprint: Life-cycle stages A1 to C4 from EPD, in conformity with ISO 14025 / EN 15804

	kg CO ₂ equiv/m ²
Focus E	3,66
Focus E/Plant	2,35

Circularity: Minimum post-consumer recycled content: 55%, Recyclability: Fully recyclable,

Fire safety: The glass wool core of the tiles is tested and classified as non-combustible according to EN ISO 1182. Europe: EN 13501-1, A2-s1,d0,

Humidity Resistance: According to EN 13964:2014 Standard: Class C, RH 95% and 30°C, Plant: Class A, RH 70% and 25°C,

Visual appearance: White Frost, nearest NCS colour sample S 0500-N, 85% light reflectance. Gloss < 1.

Cleanability: Daily dusting and vacuum cleaning. Weekly wet wiping.

Accessibility: The tiles are easily demountable. Minimum demounting depth according to installation diagrams.

Installation: Installed according to installation diagrams, installation guides and drawing aid. For information regarding minimum overall depth of system see quantity specification.

System weight: The weight of the system (including suspension grid) should be approximately 3 kg/m².

Mechanical properties: See table about Max live load and Min load bearing capacity and Functional demands, Mechanical properties at www.ecophon.com.

CE: Ecophon ceiling systems are CE marked according to the European harmonized standard EN13964:2014. CE marked construction products are covered by a Declaration of Performance (DOP) which enables customers and users to easily compare performance of products available on the European market.

Installation diagram in detail www.ecophon.com

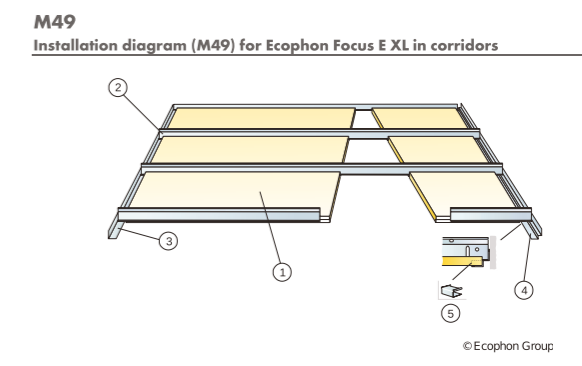
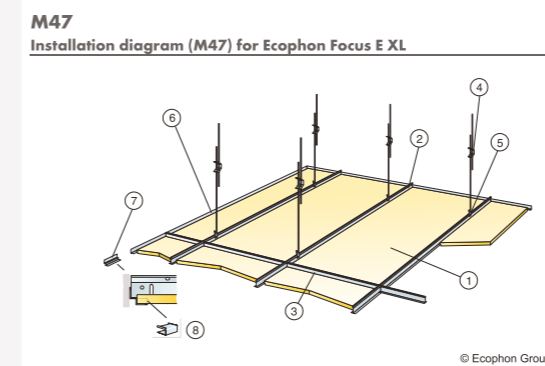
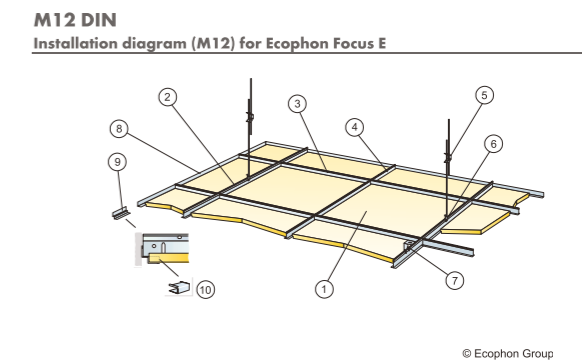
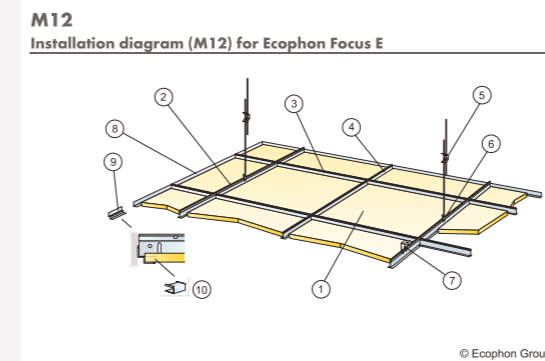

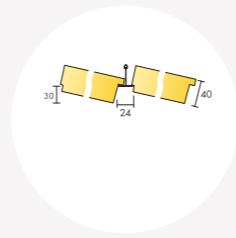

Ecophon Focus™ Ez

Acoustic:

Sound Absorption:

Test results according to EN ISO 354. Classification according to EN ISO 11654, and the single value ratings for Noise Reduction Coefficient, NRC and Sound Absorption Average, SAA according to ASTM C 423.

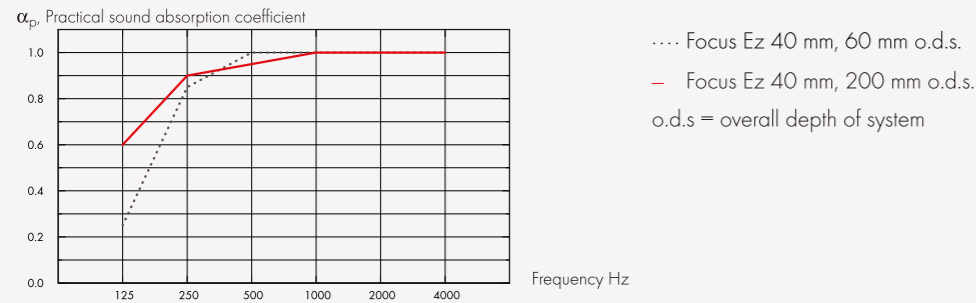

THK mm	o.d.s. mm	α_p , Practical sound absorption coefficient						α_w	Sound absorption class
		125 Hz	250 Hz	500 Hz	1000 Hz	2000 Hz	4000 Hz		
40	60	0.25	0.85	1.00	1.00	1.00	1.00	1.00	A
40	200	0.60	0.90	0.95	1.00	1.00	1.00	1.00	A

	THK mm	o.d.s. mm	NRC	SAA
-	40	60	1.00	0.99
-	40	200	1.00	0.97

THK mm	AC(1.5)		D_{ntw}	CAC dB
	Articulation Class, ASTM E1111, ASTM E1110			
40	200		29	31

Indoor Air Quality:

Certificate / Label	
Eurofins Indoor Air Comfort®	IAC
French VOC	A
Finnish M1	•

Environmental Footprint: Life-cycle stages A1 to C4 from EPD, in conformity with ISO 14025 / EN 15804

	kg CO ₂ equiv/m ²
Focus Ez	5,9

Circularity: Minimum post-consumer recycled content: 62%, Recyclability: Fully recyclable,

Fire safety: The glass wool core of the tiles is tested and classified as non-combustible according to EN ISO 1182. Europe: EN 13501-1, A2-s1,d0,

Humidity Resistance: Class C, relative humidity 95% and 30°C, according to EN 13964:2014

Visual appearance: White Frost, nearest NCS colour sample S 0500-N, 85% light reflectance. Gloss < 1.

Cleanability: Daily dusting and vacuum cleaning. Weekly wet wiping.

Accessibility: The tiles are easily demountable. Minimum demounting depth according to installation diagrams.

Installation: Installed according to installation diagrams, installation guides and drawing aid. For information regarding minimum overall depth of system see quantity specification.

System weight: The weight of the system (including suspension grid) should be approximately 5 kg/m²

Mechanical properties: See table about Max live load and Min load bearing capacity and Functional demands, Mechanical properties at www.ecophon.com.

CE: Ecophon ceiling systems are CE marked according to the European harmonized standard EN13964:2014. CE marked construction products are covered by a Declaration of Performance (DOP) which enables customers and users to easily compare performance of products available on the European market.

Installation diagram in detail www.ecophon.com

M393

Installation diagram (M393) for Ecophon Focus Ez

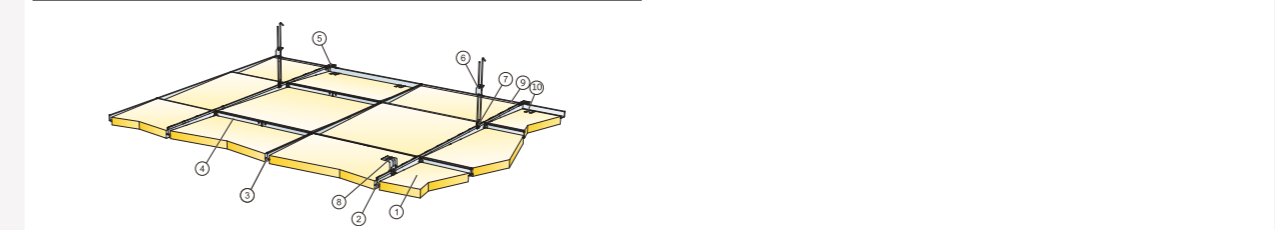

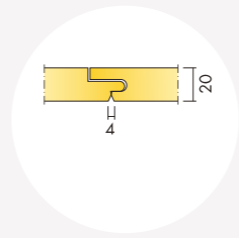

Ecophon Focus™ F

Acoustic:

Sound Absorption:

Test results according to EN ISO 354. Classification according to EN ISO 11654, and the single value ratings for Noise Reduction Coefficient, NRC and Sound Absorption Average, SAA according to ASTM C 423.

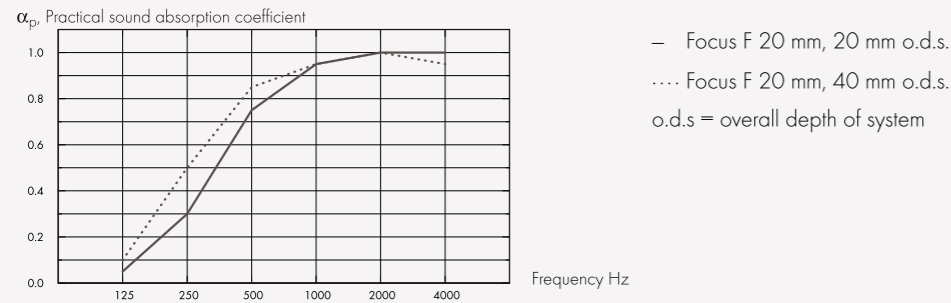

THK mm	o.d.s. mm	α_p , Practical sound absorption coefficient						α_w	Sound absorption class
		125 Hz	250 Hz	500 Hz	1000 Hz	2000 Hz	4000 Hz		
20	20	0.05	0.30	0.75	0.95	1.00	1.00	0.60	C
20	40	0.10	0.50	0.85	0.95	1.00	0.95	0.80	B

	THK mm	o.d.s. mm	NRC	SAA
-	20	20	0.75	0.76
-	20	40	0.85	0.82

Indoor Air Quality:

Certificate / Label	
Eurofins Indoor Air Comfort®	IAC
French VOC	A
Finnish M1	•

Environmental Footprint: Life-cycle stages A1 to C4 from EPD, in conformity with ISO 14025 / EN 15804

	kg CO ₂ equiv/m ²
Focus F	4,90

Circularity: Minimum post-consumer recycled content: 59%, Recyclability: Fully recyclable,

Fire safety: The glass wool core of the tiles is tested and classified as non-combustible according to EN ISO 1182. Europe: EN 13501-1, A2-s1,d0,

Humidity Resistance: Class C, relative humidity 95% and 30°C, according to EN 13964:2014

Visual appearance: White Frost, nearest NCS colour sample S 0500-N, 85% light reflectance. Gloss < 1.

Cleanability: Daily dusting and vacuum cleaning. Weekly wet wiping.

Accessibility: The tiles are not demountable.

Installation: Installed according to installation diagrams, installation guides and drawing aid. For information regarding minimum overall depth of system see quantity specification. For best result the surface should be even, however an acceptable result could be achieved on slightly uneven surfaces. If very uneven surfaces - installation of furring (evenly spaced timber battens) as the substrate for the tiles is recommended.

System weight: The weight of the system should be approximately 2,5 kg/m²

Mechanical properties: Additional live load has to be fixed to the soffit.

CE: Ecophon ceiling systems are CE marked according to the European harmonized standard EN13964:2014. CE marked construction products are covered by a Declaration of Performance (DOP) which enables customers and users to easily compare performance of products available on the European market.

Installation diagram in detail www.ecophon.com

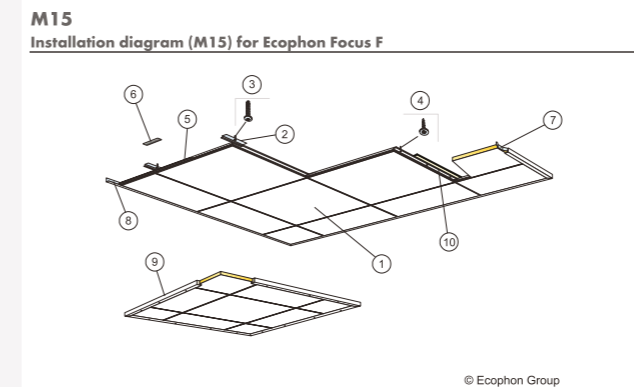

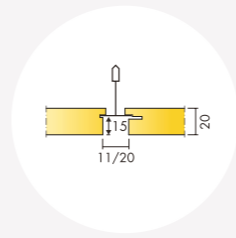

Ecophon Focus™ Lp

Acoustic:

Sound Absorption:

Test results according to EN ISO 354. Classification according to EN ISO 11654, and the single value ratings for Noise Reduction Coefficient, NRC and Sound Absorption Average, SAA according to ASTM C 423.

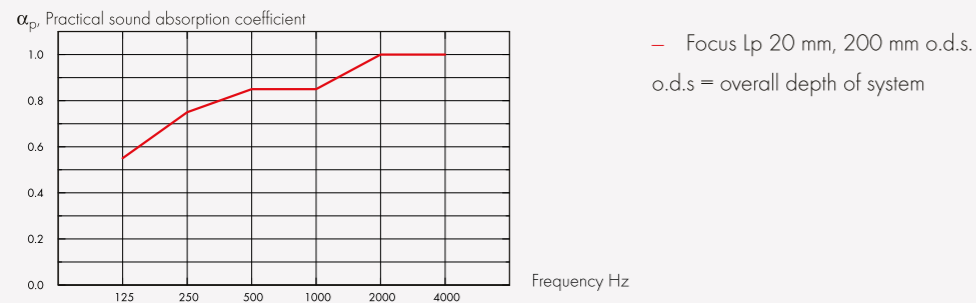

THK mm	o.d.s. mm	α_p , Practical sound absorption coefficient						α_w	Sound absorption class
		125 Hz	250 Hz	500 Hz	1000 Hz	2000 Hz	4000 Hz		
20	200	0.55	0.75	0.85	0.85	1.00	1.00	0.90	A

THK mm	o.d.s. mm	NRC	SAA
20	400	0.80	0.82

THK mm	AC(1.5)		D_{ntw}	CAC dB
	Articulation Class, ASTM E1111, ASTM E1110			
20	180		24	25

Indoor Air Quality:

Certificate / Label	Standard
Eurofins Indoor Air Comfort®	IAC
French VOC	A
Finnish M1	•

Environmental Footprint: Life-cycle stages A1 to C4 from EPD, in conformity with ISO 14025 / EN 15804

	kg CO ₂ equiv/m ²
Focus Lp	4,66

Circularity: Minimum post-consumer recycled content: 57%, Recyclability: Fully recyclable,

Fire safety: The glass wool core of the tiles is tested and classified as non-combustible according to EN ISO 1182. Europe: EN 13501-1, A2-s1,d0,

Humidity Resistance: Class C, relative humidity 95% and 30°C, according to EN 13964:2014

Visual appearance: White Frost, nearest NCS colour sample S 0500-N, 85% light reflectance. Gloss < 1.

Cleanability: Daily dusting and vacuum cleaning. Weekly wet wiping.

Accessibility: The tiles are easily demountable. Minimum demounting depth according to installation diagrams.

Installation: Installed according to installation diagrams, installation guides and drawing aid. For information regarding minimum overall depth of system see quantity specification. The systems are not recommended for small rooms (approximately 2x2 m²). Ceilings with a large amount of integrations require careful planning, design and installation.

System weight: The weight of the system (including suspension grid) should be approximately 3-4 kg/m².

Mechanical properties: See table about Max live load and Min load bearing capacity and Functional demands, Mechanical properties at www.ecophon.com. For the Technical tiles installed according to M391 there is a load bearing capacity of 100 N for each Main runner per 1200 mm. This gives a total load bearing capacity of 200 N for a load evenly distributed on two Main runners.

CE: Ecophon ceiling systems are CE marked according to the European harmonized standard EN13964:2014. CE marked construction products are covered by a Declaration of Performance (DOP) which enables customers and users to easily compare performance of products available on the European market.

Indoor Air Quality:

Certificate / Label	Standard
Eurofins Indoor Air Comfort®	IAC
French VOC	A
Finnish M1	•

Installation diagram in detail www.ecophon.com

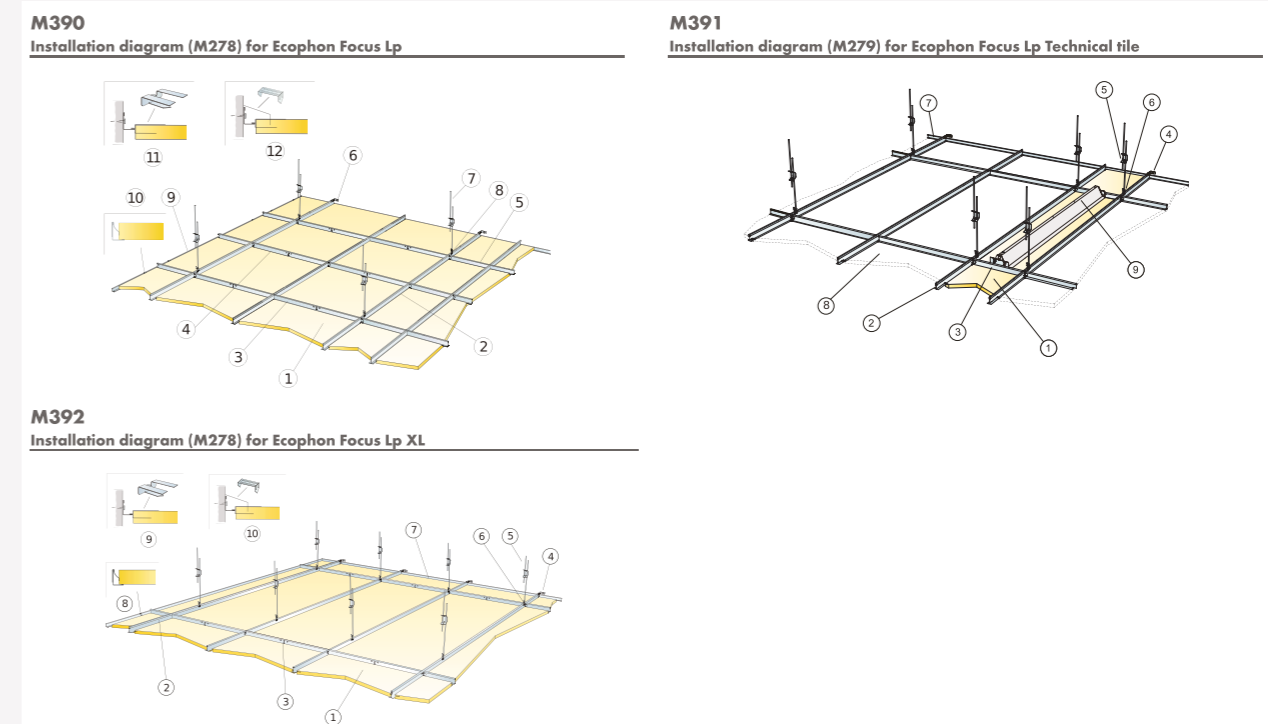

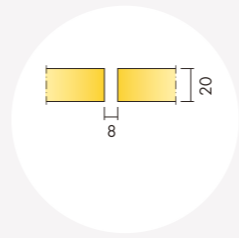

Ecophon Focus™ SQ

Acoustic:

Sound Absorption:

Test results according to EN ISO 354. Classification according to EN ISO 11654, and the single value ratings for Noise Reduction Coefficient, NRC and Sound Absorption Average, SAA according to ASTM C 423.

α_p , Practical sound absorption coefficient

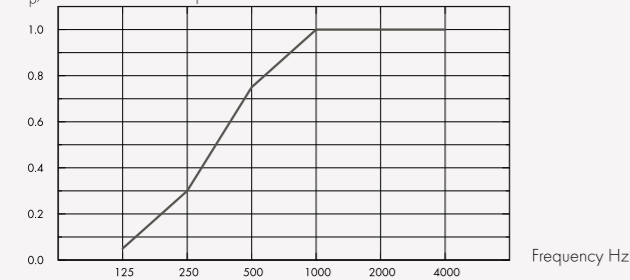

— Focus SQ 20 mm, 23 mm o.d.s.
o.d.s = overall depth of system

THK mm	o.d.s. mm	α_p , Practical sound absorption coefficient						α_w	Sound absorption class
		125 Hz	250 Hz	500 Hz	1000 Hz	2000 Hz	4000 Hz		
20	23	0.05	0.30	0.75	1.00	1.00	1.00	0.60	C

THK mm	o.d.s. mm	NRC	SAA
20	23	0.75	0.78

THK mm	AC(1.5)
20	190

Articulation Class, ASTM E1111, ASTM E1110

Indoor Air Quality:

Certificate / Label

Eurofins Indoor Air Comfort®	IAC
French VOC	A
Finnish M1	•

Environmental Footprint: Life-cycle stages A1 to C4 from EPD, in conformity with ISO 14025 / EN 15804

	kg CO ₂ equiv/m ²
Focus SQ	4,88

Circularity: Minimum post-consumer recycled content: 57%, Recyclability: Fully recyclable,

Fire safety: The glass wool core of the tiles is tested and classified as non-combustible according to EN ISO 1182. Europe: EN 13501-1, A2-s1,d0,

Humidity Resistance: Class C, relative humidity 95% and 30°C, according to EN 13964:2014

Visual appearance: White Frost, nearest NCS colour sample S 0500-N, 85% light reflectance. Gloss < 1.

Cleanability: Daily dusting and vacuum cleaning. Weekly wet wiping.

Accessibility: The tiles are not demountable.

Installation: Installed according to installation diagrams, installation guides and drawing aid. For information regarding minimum overall depth of system see quantity specification. Rendered surfaces must have sufficient strength to be able to carry the load imposed by the tiles. If doubts, test gluing should be carried out. The surface should always be dry and clean. For best result the surface should be even, however an acceptable result could be achieved on slightly uneven surfaces.

System weight: The weight of the system should be approximately 2,5 kg/m²

Mechanical properties: Additional live load has to be fixed to the soffit.

CE: Ecophon ceiling systems are CE marked according to the European harmonized standard EN13964:2014. CE marked construction products are covered by a Declaration of Performance (DOP) which enables customers and users to easily compare performance of products available on the European market.

Installation diagram in detail www.ecophon.com

M107
Installation diagram (M107) for Ecophon Focus SQ, using Connect Absorber glue

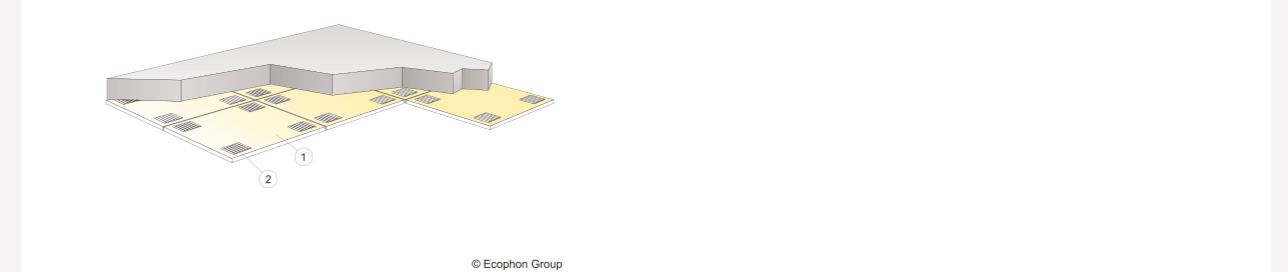

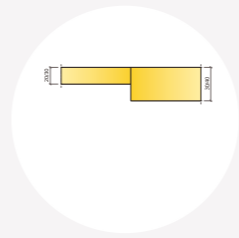

Ecophon Focus™ Levels

Acoustic:

Sound Absorption:

Test results according to EN ISO 354. Classification according to EN ISO 11654, and the single value ratings for Noise Reduction Coefficient, NRC and Sound Absorption Average, SAA according to ASTM C 423.

α_p , Practical sound absorption coefficient

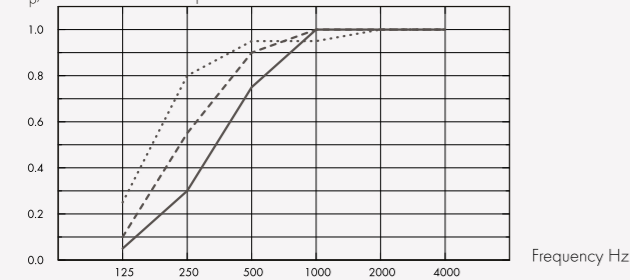

..... Focus Levels 40 mm, 43 mm o.d.s.
 --- Focus Levels 30 mm, 33 mm o.d.s.
 — Focus Levels 20 mm, 23 mm o.d.s.
 o.d.s = overall depth of system

α_p , Practical sound absorption coefficient

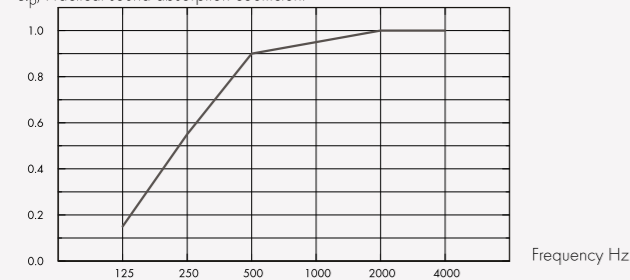

— Focus Levels 20/30/40 mm (M488, M489), 23-43 mm o.d.s.
 o.d.s = overall depth of system

THK mm	o.d.s. mm	α_p , Practical sound absorption coefficient						α_w	Sound absorption class
		125 Hz	250 Hz	500 Hz	1000 Hz	2000 Hz	4000 Hz		
40	43	0.25	0.80	0.95	0.95	1.00	1.00	A	
30	33	0.10	0.55	0.90	1.00	1.00	1.00	B	
20	23	0.05	0.30	0.75	1.00	1.00	1.00	C	
0	43	0.15	0.55	0.90	0.95	1.00	1.00	B	

THK mm	o.d.s. mm	NRC	SAA
-	20	0.75	0.78

Indoor Air Quality:

Certificate / Label

Eurofins Indoor Air Comfort®	IAC
French VOC	A
Finnish M1	•

Environmental Footprint: Life-cycle stages A1 to C4 from EPD, in conformity with ISO 14025 / EN 15804

	kg CO ₂ equiv/m ²
Focus Levels 20mm	5,03
Focus Levels 30mm	6,23
Focus Levels 40mm	7,44

Circularity: Minimum post-consumer recycled content (20 mm): 58%, Minimum post-consumer recycled content (30 mm): 62%, Minimum post-consumer recycled content (40 mm): 64%, Recyclability: Fully recyclable,

Fire safety: The glass wool core of the tiles is tested and classified as non-combustible according to EN ISO 1182. Europe: EN 13501-1, A2-s1,d0,

Humidity Resistance: Class C, relative humidity 95% and 30°C, according to EN 13964:2014

Visual appearance: White Frost, nearest NCS colour sample S 0500-N, 85% light reflectance. Gloss < 1.

Cleanability: Daily dusting and vacuum cleaning. Weekly wet wiping.

Accessibility: The tiles are not demountable.

Installation: Installed according to installation diagrams, installation guides and drawing aid. For information regarding minimum overall depth of system see quantity specification. Rendered surfaces must have sufficient strength to be able to carry the load imposed by the tiles. If doubts, test gluing should be carried out. The surface should always be dry and clean. For best result the surface should be even, however an acceptable result could be achieved on slightly uneven surfaces.

Mechanical properties: Additional live load has to be fixed to the soffit.

CE: Ecophon ceiling systems are CE marked according to the European harmonized standard EN13964:2014. CE marked construction products are covered by a Declaration of Performance (DOP) which enables customers and users to easily compare performance of products available on the European market.

Installation diagram in detail www.ecophon.com

M488
Installation diagram (M488) for Ecophon Focus Levels, using Connect Absorber glue

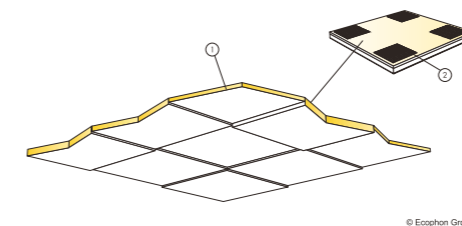

M489
Installation diagram (M489) for Ecophon Focus Levels, using Connect Absorber glue

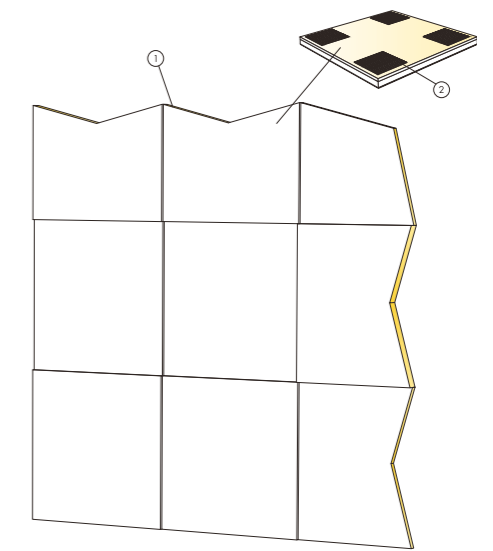

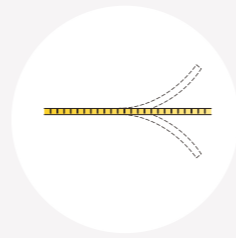

Ecophon Focus™ Flexiform A

Acoustic: Acoustic values corresponding to a flat ceiling.

Sound Absorption:

Test results according to EN ISO 354. Classification according to EN ISO 11654, and the single value ratings for Noise Reduction Coefficient, NRC and Sound Absorption Average, SAA according to ASTM C 423.

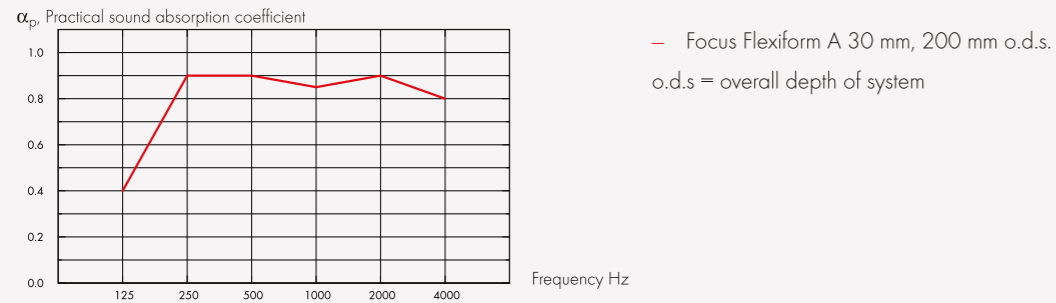

THK mm	o.d.s. mm	α_p , Practical sound absorption coefficient						α_w	Sound absorption class
		125 Hz	250 Hz	500 Hz	1000 Hz	2000 Hz	4000 Hz		
30	200	0.40	0.90	0.90	0.85	0.90	0.80	0.90	A

THK mm	D_{nfw}		CAC dB	
	Weighted normalized flanking level difference, ISO 10848-2		Ceiling Attenuation Class, ASTM 1414, ASTM E413	
20	24		25	

Environmental Footprint: Life-cycle stages A1 to C4 from EPD, in conformity with ISO 14025 / EN 15804

	kg CO ₂ equiv/m ²
Focus Flexiform A	3,1

Circularity: Minimum post-consumer recycled content: 39%, Recyclability: Fully recyclable,

Fire safety: The glass wool core of the tiles is tested and classified as non-combustible according to EN ISO 1182. Europe: EN 13501-1, A2-s1,d0,

Humidity Resistance: Class C, relative humidity 95% and 30°C, according to EN 13964:2014

Visual appearance: White Frost, nearest NCS colour sample S 0500-N, 85% light reflectance. Gloss < 1.

Cleanability: Daily dusting and vacuum cleaning. Weekly wet wiping.

Accessibility: The tiles are not demountable.

Installation: Installed according to installation diagrams, installation guides and drawing aid. (Please note: Extreme incident light, near windows or other light sources, can create undesired shadow effects on the structured surface on curved installations.)

System weight: The weight is approximately 3 kg/m², depending on the installation method.

Mechanical properties: Additional live load has to be fixed to the soffit.

CE: Ecophon ceiling systems are CE marked according to the European harmonized standard EN13964:2014. CE marked construction products are covered by a Declaration of Performance (DOP) which enables customers and users to easily compare performance of products available on the European market.

Installation diagram in detail www.ecophon.com

M31
Installation diagram (M31) for Ecophon Focus Flexiform A

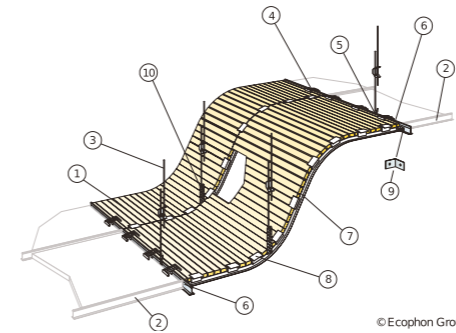

M31ec
Installation diagram (M31EC) for Ecophon Focus Flexiform A external corner

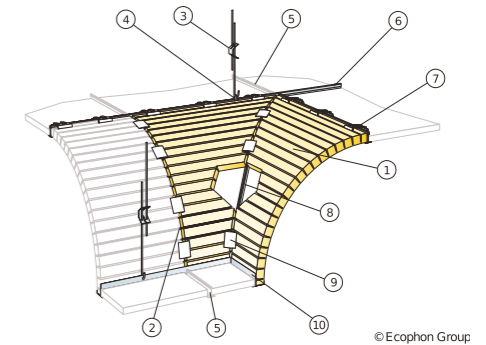

M31ic
Installation diagram (M31IC) for Ecophon Focus Flexiform A internal corner

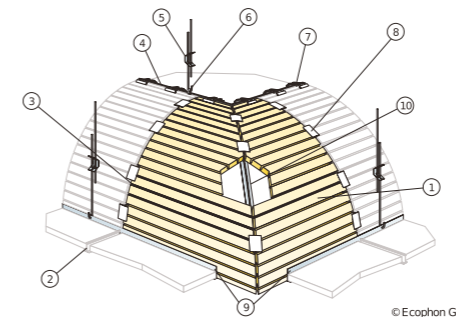

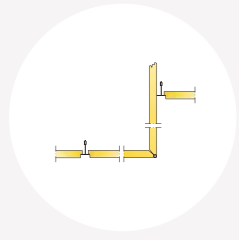
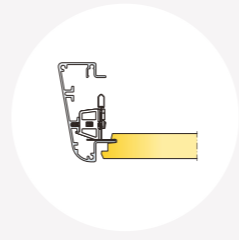

Ecophon Focus Edge™ 500

Acoustic: Ecophon Focus Edge 500 is a perimeter component. For acoustic data on the system - please see corresponding ceiling system (Focus Ds, Focus Dg or Focus/Master E).

Circularity: Fully recyclable.

Fire safety: Europe: EN 13501-1, A1,

Installation: Installed according to installation diagrams, installation guides and drawing aid. For information regarding minimum overall depth of system see quantity specification.

Mechanical properties: Additional live load has to be fixed to the soffit.

CE: Ecophon ceiling systems are CE marked according to the European harmonized standard EN13964:2014. CE marked construction products are covered by a Declaration of Performance (DOP) which enables customers and users to easily compare performance of products available on the European market.

Installation diagram in detail www.ecophon.com

M165
Installation diagram (M165) for Ecophon Edge 500 with Focus E T24

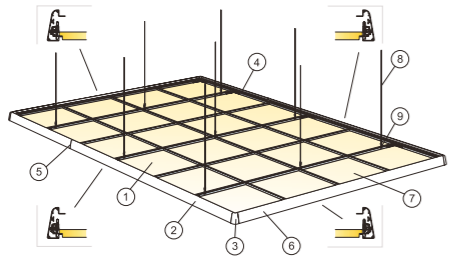

© Ecophon Group

M210
Installation diagram (M210) for Ecophon Edge 500 with Focus Ds

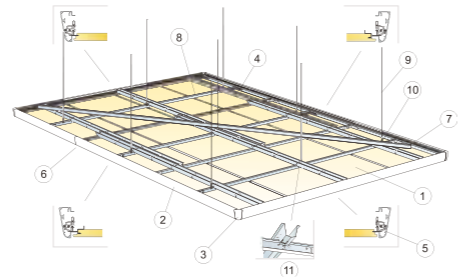

M211
Installation diagram (M211) for Ecophon Edge 500 with Focus Dg

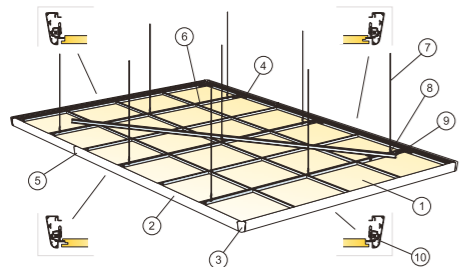

© Ecophon Group

Ecophon Focus™ Fixiform E

Acoustic: Acoustic values corresponding to a flat ceiling.

Sound Absorption: Test results according to EN ISO 354. Classification according to EN ISO 11654, and the single value ratings for Noise Reduction Coefficient, NRC and Sound Absorption Average, SAA according to ASTM C 423.

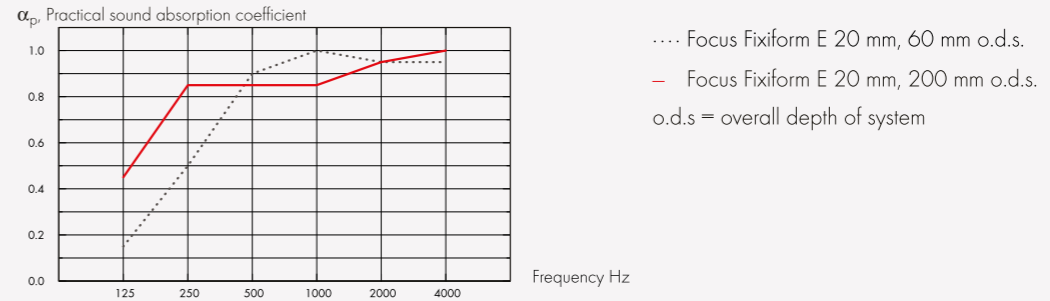

THK mm	o.d.s. mm	α_p , Practical sound absorption coefficient						α_w	Sound absorption class
		125 Hz	250 Hz	500 Hz	1000 Hz	2000 Hz	4000 Hz		
20	60	0.15	0.50	0.90	1.00	0.95	0.95	0.80	B
20	200	0.45	0.85	0.85	0.85	0.95	1.00	0.90	A

THK mm	D_{nfw}		CAC dB	
	Weighted normalized flanking level difference, ISO 10848-2		Ceiling Attenuation Class, ASTM 1414, ASTM E413	
20	24		25	

Indoor Air Quality:

Certificate / Label	
Eurofins Indoor Air Comfort®	IAC
French VOC	A
Finnish M1	•

Circularity: Minimum post-consumer recycled content: 57%, Recyclability: Fully recyclable,

Fire safety: The glass wool core of the tiles is tested and classified as non-combustible according to EN ISO 1182. Europe: EN 13501-1, A2-s1,d0,

Humidity Resistance: Class C, relative humidity 95% and 30°C, according to EN 13964:2014

Visual appearance: White Frost, nearest NCS colour sample S 0500-N, 85% light reflectance. Gloss < 1.

Cleanability: Daily dusting and vacuum cleaning. Weekly wet wiping.

Accessibility: The panels are demountable via adjacent flat ceiling tiles.

Installation: Installed according to installation diagrams, installation guides and drawing aid. Focus Fixiform E is supplied with all necessary installation accessories.

Mechanical properties: Additional live load has to be fixed to the soffit.

CE: Ecophon ceiling systems are CE marked according to the European harmonized standard EN13964:2014. CE marked construction products are covered by a Declaration of Performance (DOP) which enables customers and users to easily compare performance of products available on the European market.

Installation diagram in detail www.ecophon.com

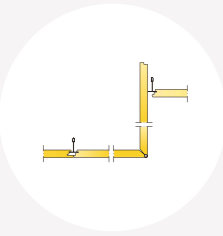
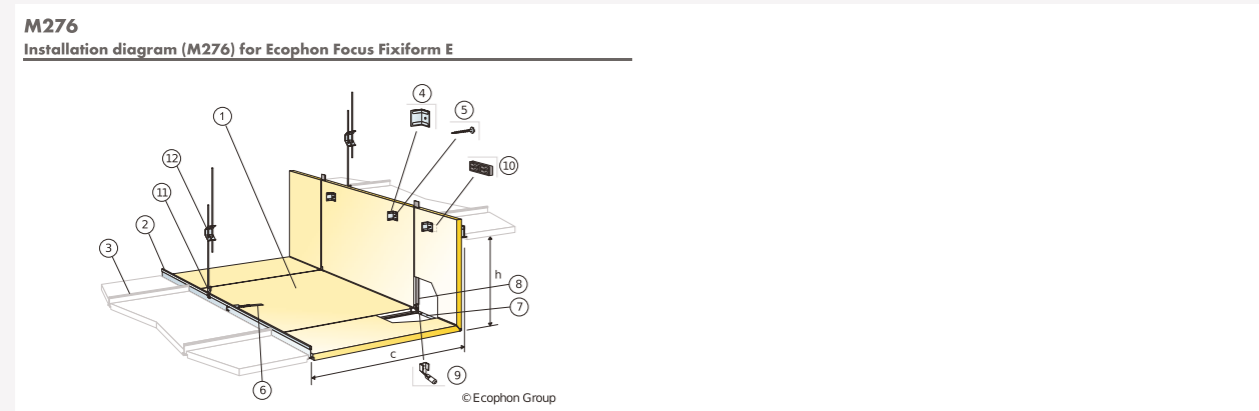

Ecophon Focus™ Fixiform Ds

Acoustic: Acoustic values corresponding to a flat ceiling.

Sound Absorption:

Test results according to EN ISO 354. Classification according to EN ISO 11654.

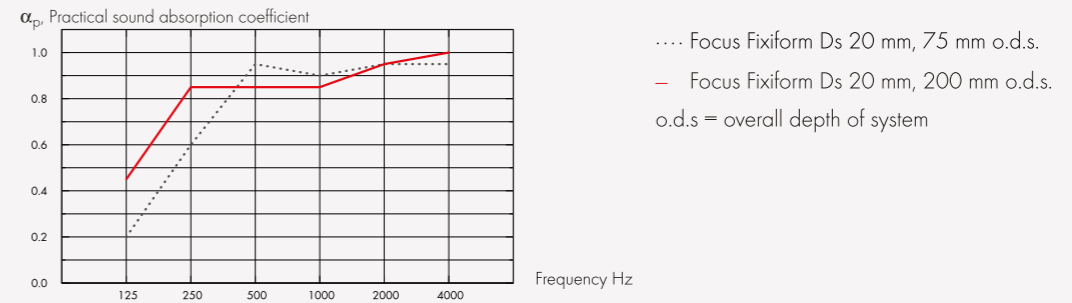

THK mm	o.d.s. mm	α_p , Practical sound absorption coefficient						α_w	Sound absorption class
		125 Hz	250 Hz	500 Hz	1000 Hz	2000 Hz	4000 Hz		
20	75	0.20	0.60	0.95	0.90	0.95	0.95	0.90	A
20	200	0.45	0.85	0.85	0.85	0.95	1.00	0.90	A

THK mm	D_{nfw}		CAC dB	
	Weighted normalized flanking level difference, ISO 10848-2		Ceiling Attenuation Class, ASTM 1414, ASTM E413	
20	24		25	

Indoor Air Quality:

Certificate / Label	
Eurofins Indoor Air Comfort®	IAC
French VOC	A
Finnish M1	•

Circularity: Minimum post-consumer recycled content: 57%, Recyclability: Fully recyclable,

Fire safety: The glass wool core of the tiles is tested and classified as non-combustible according to EN ISO 1182. Europe: EN 13501-1, A2-s1,d0,

Humidity Resistance: Class C, relative humidity 95% and 30°C, according to EN 13964:2014

Visual appearance: White Frost, nearest NCS colour sample S 0500-N, 85% light reflectance. Gloss < 1.

Cleanability: Daily dusting and vacuum cleaning. Weekly wet wiping.

Accessibility: The panels are demountable via adjacent flat ceiling tiles.

Installation: Installed according to installation diagrams, installation guides and drawing aid. Focus Fixiform Ds is supplied with all necessary installation accessories.

Mechanical properties: Additional live load has to be fixed to the soffit.

CE: Ecophon ceiling systems are CE marked according to the European harmonized standard EN13964:2014. CE marked construction products are covered by a Declaration of Performance (DOP) which enables customers and users to easily compare performance of products available on the European market.

Installation diagram in detail www.ecophon.com

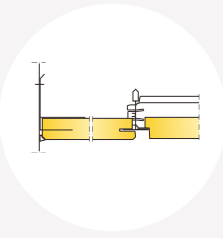
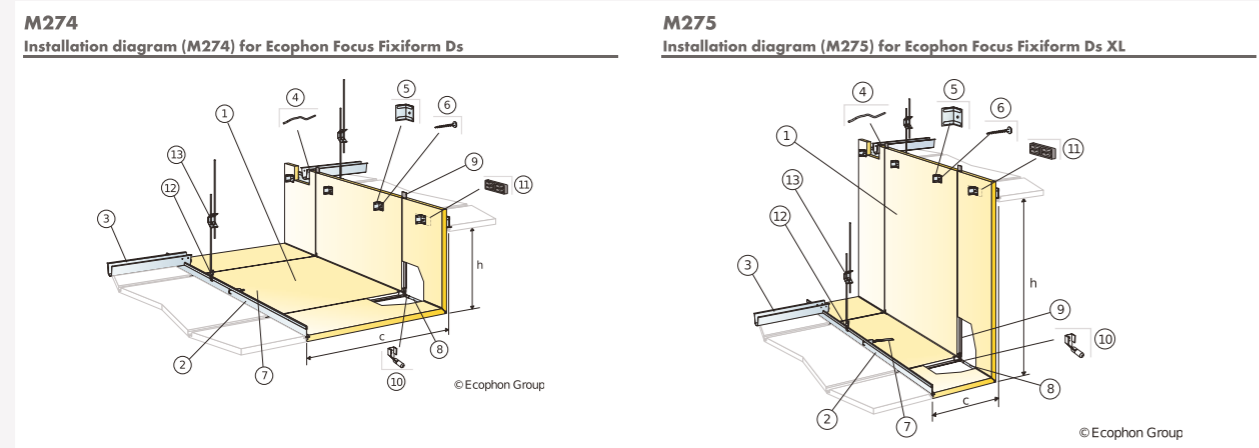

Ecophon Focus™ Frieze

Acoustic:

Sound Absorption:

Test results according to EN ISO 354. Classification according to EN ISO 11654, and the single value ratings for Noise Reduction Coefficient, NRC and Sound Absorption Average, SAA according to ASTM C 423.

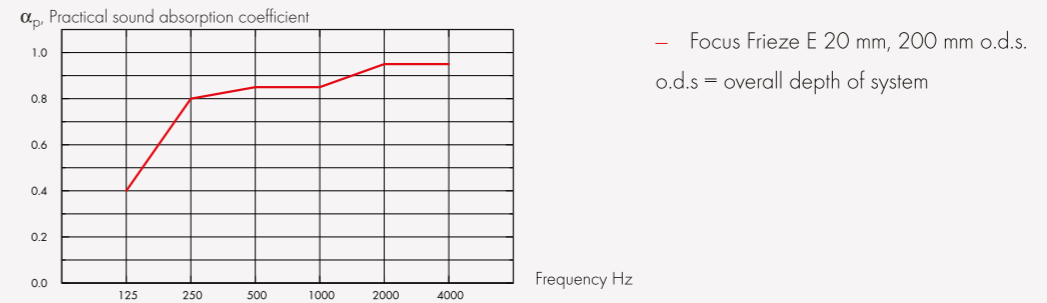

THK mm	o.d.s. mm	α_p , Practical sound absorption coefficient						α_w	Sound absorption class
		125 Hz	250 Hz	500 Hz	1000 Hz	2000 Hz	4000 Hz		
20	200	0.40	0.80	0.85	0.85	0.95	0.95	0.90	A

THK mm	AC(1.5) Articulation Class, ASTM E1111, ASTM E1110	D_{nfw} Weighted normalized flanking level difference, ISO 10848-2	CAC dB Ceiling Attenuation Class, ASTM 1414, ASTM E413
20	190	24	25

Indoor Air Quality:

Certificate / Label

Eurofins Indoor Air Comfort®	IAC
French VOC	A
Finnish M1	•

Circularity: Minimum post-consumer recycled content: 59%, Recyclability: Fully recyclable,

Fire safety: The glass wool core of the tiles is tested and classified as non-combustible according to EN ISO 1182. Europe: EN 13501-1, A2-s1,d0,

Humidity Resistance: Class C, relative humidity 95% and 30°C, according to EN 13964:2014

Visual appearance: White Frost, nearest NCS colour sample S 0500-N, 85% light reflectance. Gloss < 1.

Cleanability: Daily dusting and vacuum cleaning. Weekly wet wiping.

Accessibility: The tiles are not demountable.

Installation: Installed according to installation diagrams, installation guides and drawing aid. For information regarding minimum overall depth of system see quantity specification.

System weight: The system consists of Ecophon Focus™ frieze tiles and Connect™ grid systems, with an approximate weight of 3 kg/m².

Mechanical properties: See table about Max live load and Min load bearing capacity and Functional demands, Mechanical properties at www.ecophon.com.

CE: Ecophon ceiling systems are CE marked according to the European harmonized standard EN13964:2014. CE marked construction products are covered by a Declaration of Performance (DOP) which enables customers and users to easily compare performance of products available on the European market.

Installation diagram in detail www.ecophon.com

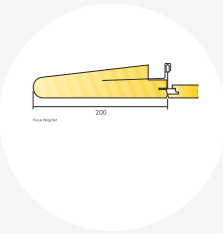
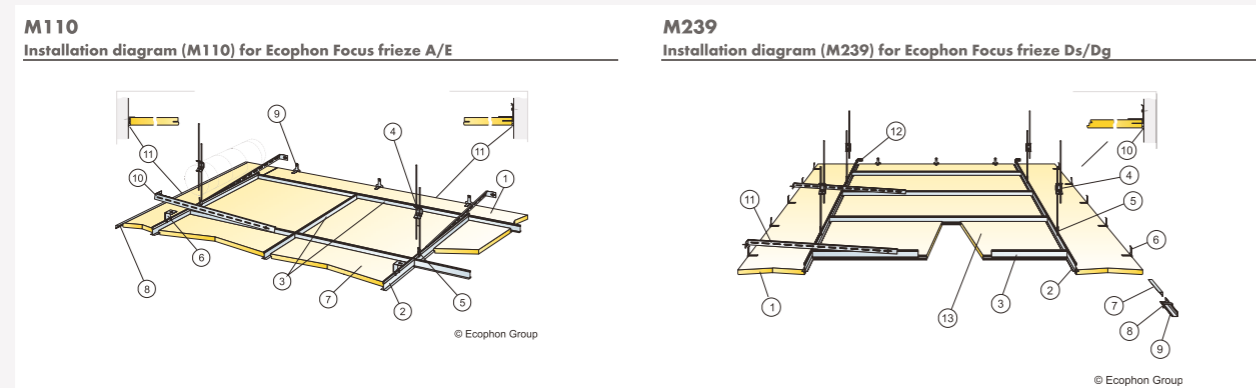

Ecophon Focus™ Wing

Acoustic: Ecophon Focus Wing is a perimeter component. As such it is absorbent, however, for acoustic data on the system - please see corresponding ceiling system (Focus Ds or Focus/Master E).

Indoor Air Quality:

Certificate / Label	
Eurofins Indoor Air Comfort®	IAC Gold
French VOC	A+

Circularity: Minimum post-consumer recycled content: 61%, Recyclability: Fully recyclable,

Fire safety: The glass wool core of the tiles is tested and classified as non-combustible according to EN ISO 1182. Europe: EN 13501-1, A2-s1,d0,

Humidity Resistance: Class C, relative humidity 95% and 30°C, according to EN 13964:2014

Visual appearance: White Frost, nearest NCS colour sample S 0500-N, 85% light reflectance. Gloss < 1.

Cleanability: Daily dusting and vacuum cleaning. Weekly wet wiping.

Accessibility: The tiles are not demountable.

Installation: Installed according to installation diagrams, installation guides and drawing aid. For information regarding minimum overall depth of system see quantity specification.

System weight: The systems consist of Ecophon Focus™ Wing elements and Connect™ grid systems, with an approximate weight of 1 kg/m.

Mechanical properties: No additional live load is allowed.

CE: Ecophon ceiling systems are CE marked according to the European harmonized standard EN13964:2014. CE marked construction products are covered by a Declaration of Performance (DOP) which enables customers and users to easily compare performance of products available on the European market.

Installation diagram in detail www.ecophon.com

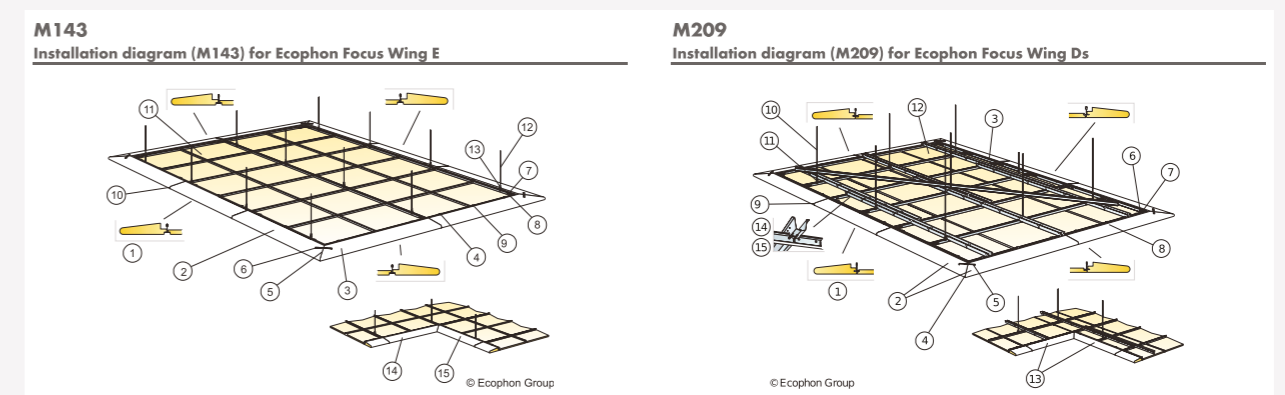

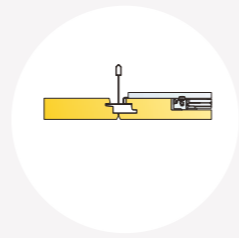

Ecophon Square 43™

Lighting performance:

System effect: 27 W Light source: LED 24,5 W Luminous flux Square Dg, Ds, E: 3281 lm Luminous flux Square Eg, Ez: 2898 lm Light efficiency Square Dg, Ds, E: 121,4 lm/W Light efficiency Square Dg, Ds, E: 108 lm/W Colour temperature: 4000K Color rendering index: Ra ≥80 Colour tolerance: MacAdam ≤3 SDCM Light output ratio (LOR): 100% Light distribution up/down: 0/100 Expected lifespan: L90 >50 000 h Expected lifespan: L70 >100 000 h

Connection: The standard on/off electronic HF ballast delivered with 2,5 meters of cable 3x0,75 mm² and Euro plugg. The SwitchDIM/DALI delivered without cable.

Electrical data: 220-240 V, 50-60 Hz, power factor cos φ>0,98. Electronic HF ballast or electronic HF dim ballast for digital regulation. Light source: led module of 27W total.

Electrical approvals: IP20, Class 1.

Visual appearance: Tile surface finish; White Frost, nearest NCS colour sample S 0500-N, 85% light reflectance. Gloss < 1.

Cleanability: Daily dusting and vacuum cleaning. Weekly wet wiping.

Accessibility: The tiles are easily demountable. Minimum demounting depth according to installation diagrams.

Installation: Installed according to system range which include information regarding minimum overall depth of system. The tile with luminaire housing rests on the T-profiles and the SwitchDIM/DALI and standard on/off ballasts are fastened to the grid or tile next to the luminaire with velcro. Once the tile with luminaire and ballast are in place a certified installation electrician must connect the wiring to sockets or to the next luminaire.

Installation diagram in detail www.ecophon.com

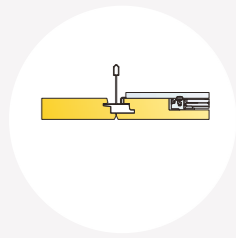
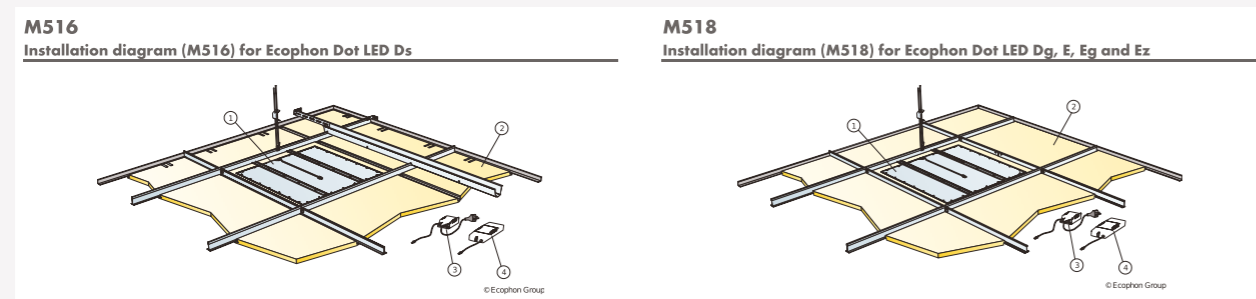

Ecophon Dot™

Lighting performance:

System effect Dot: 27 W Light source: LED 24,5 W Luminous flux Dot Dg, Ds, E: 2936 lm Luminous flux Dot Eg, Ez: 2635 lm Light efficiency Dot Dg, Ds, E: 108,7 lm/W Light efficiency Dot Eg, Ez: 99 lm/W Colour temperature: 4000K Color rendering index: Ra ≥80 Colour tolerance: MacAdam ≤3 SDCM Light output ratio (LOR): 100% Light distribution up/down: 0/100 Expected lifespan: L90 >50 000 h Expected lifespan: L70 >100 000 h

Connection: The standard on/off electronic HF ballast delivered with 2,5 meters of cable 3x0,75 mm² and Euro plugg. The SwitchDIM/DALI delivered without cable.

Electrical data: 220-240 V, 50-60 Hz, power factor cos φ>0,98. Electronic HF ballast or electronic HF dim ballast for digital regulation. Light source: led module of 27W total.

Electrical approvals: IP20, Class 1.

Visual appearance: Tile surface finish; White Frost, nearest NCS colour sample S 0500-N, 85% light reflectance. Gloss < 1.

Cleanability: Daily dusting and vacuum cleaning. Weekly wet wiping.

Accessibility: The tiles are easily demountable. Minimum demounting depth according to installation diagrams.

Installation: Installed according to system range which include information regarding minimum overall depth of system. The tile with luminaire housing rests on the T-profiles and the SwitchDIM/DALI and standard on/off ballasts are fastened to the grid or tile next to the luminaire with velcro. Once the tile with luminaire and ballast are in place a certified installation electrician must connect the wiring to sockets or to the next luminaire.

Installation diagram in detail www.ecophon.com

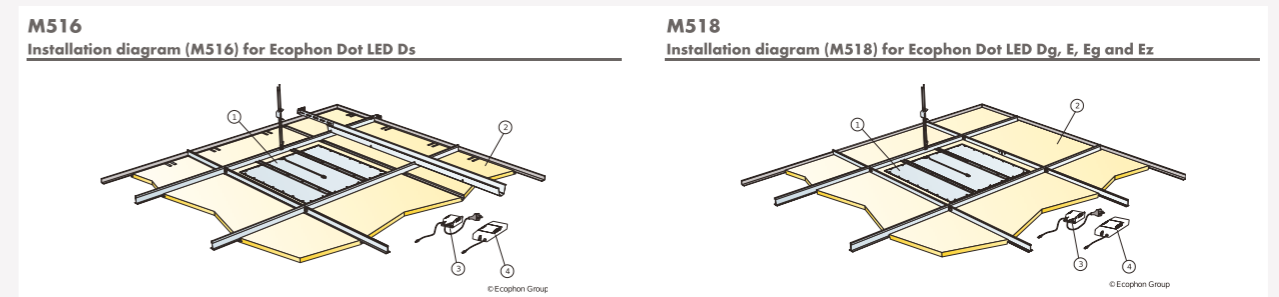

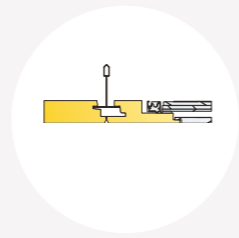

Ecophon Line™

Lighting performance:

System effect: 29,4W Light source: LED 26,7 W Luminous flux: 2337 lm Light efficiency: 87,5 lm/W Colour temperature: 4000K Color rendering index: Ra ≥80 Colour tolerance: MacAdam ≤3 SDCM Light output ratio (LOR): 100% Light distribution up/down: 0/100 Expected lifespan: L90 >50 000 h Expected lifespan: L70 >100 000 h

Connection: The standard on/off electronic HF ballast delivered with 2,5 meters of cable 3x0,75 mm² and Euro plugg. The SwitchDIM/DALI delivered without cable.

Electrical data: 220-240 V, 50-60 Hz, power factor cos φ>0,98. Electronic HF ballast or electronic HF dim ballast for digital regulation. Light source: led module of 27W total.

Electrical approvals: IP20, Class 1.

Visual appearance: Tile surface finish; White Frost, nearest NCS colour sample S 0500-N, 85% light reflectance. Gloss < 1.

Cleanability: Daily dusting and vacuum cleaning. Weekly wet wiping.

Accessibility: The tiles are easily demountable. Minimum demounting depth according to installation diagrams.

Installation: Installed according to system range which include information regarding minimum overall depth of system. The tile with luminaire housing rests on the T-profiles and the SwitchDIM/DALI and standard on/off ballasts are fastened to the grid or tile next to the luminaire with velcro. Once the tile with luminaire and ballast are in place a certified installation electrician must connect the wiring to sockets or to the next luminaire.

Installation diagram in detail www.ecophon.com

M517
Installation diagram (M517) for Ecophon Line LED Ds

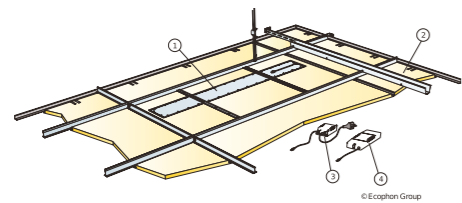

M519
Installation diagram (M519) for Ecophon Line LED Dg and E

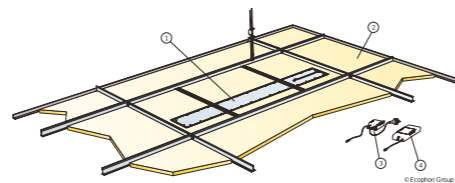

M520
Installation diagram (M520) for Ecophon Line LED Lp

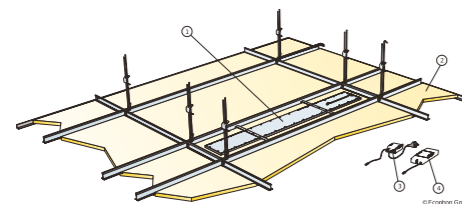

The image is showing Ecophon Focus™ Ds



Ecophon is the leading supplier of indoor acoustic solutions that improve working performance and quality of life. We believe in the difference sound can make to our everyday lives, and are passionate advocates for the importance of room acoustics to people's wellbeing - whatever the space, activity or need.

Having a sound effect on people is the principle that guides all we do. We're proud of the Swedish heritage and human approach that promise is founded on. And, as members of the Saint-Gobain Group, to be doing our part in making the world a better home.

Saint-Gobain Ecophon AB

Box 500, SE-265 03 Hyllinge, Sweden

Phone: +46 (0)42 17 99 00

Fax: +46 (0)42 22 55 55

www.ecophon.com

SE556142516501 • Based in Åstorp