

Ecophon Solo™ Square

Ecophon Solo™ Square er en frithængende enhed, der giver mange fantastiske designmuligheder. Tre forskellige ophængssystemer gør det muligt at skabe flere lag og vinkler. Produktet er velegnet, når rummets volumen skal bevares, eller når det ikke er muligt at montere et heldækkende loft.



Impol Papier, Bardo (Dobroskiel), Poland

FORMATER

<input type="checkbox"/>	Størrelse, mm	1200x1200
	Speciel montage	•
	Tykkelse (Tk.)	40
	Montageanvisning	M402, M507

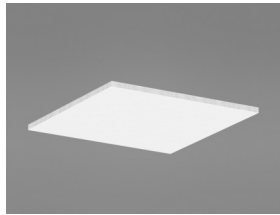

Solo Square



Solo panel

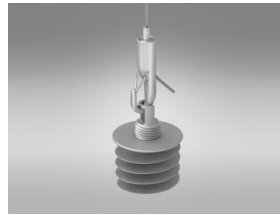

Nedhængning med Connect justerbar wire og Connect absorberent-anker



Nedhængning med Connect absorberent ophæng og Connect absorberent-anker

Akustik



Værdierne i diagrammet henviser til en enkelt enhed. Hvis enhederne placeres i en klynge med afstande på mindre end 0,5 meter, bliver A_{eq} pr. enhed let reduceret.

Lydabsorption:

Testresultater i henhold til EN ISO 354.

A_{eq} ækvivalent absorptionsareal pr. enhed (m^2 sabin)

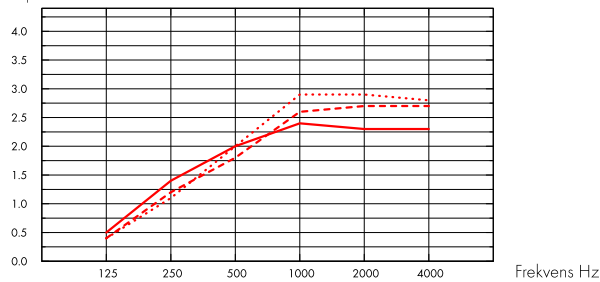

- Solo Square 1200x1200, 200 mm o.d.s.
 - - - Solo Square 1200x1200, 400 mm o.d.s.
 - · · Solo Square 1200x1200, 1000 mm o.d.s.
- o.d.s = t_{kh} = total konstruktionshøjde

Tk. mm	t _{kh} mm	A_{eq} ækvivalent absorptionsareal pr. enhed (m^2 sabin)					
		125 Hz	250 Hz	500 Hz	1000 Hz	2000 Hz	4000 Hz
40	200	0.5	1.4	2.0	2.4	2.3	2.3
40	400	0.4	1.2	1.8	2.6	2.7	2.7
40	1000	0.4	1.1	2.0	2.9	2.9	2.8



Indeklima

Certifikat / Label

Eurofins Indoor Air Comfort®

IAC Gold

Fransk VOC

A+



Cradle to Cradle Certified®



Dette produkt er Cradle to Cradle Certificeret® på bronze niveau (version 4.0).



Material Health



Dette produkt har modtaget et C2C Certified Material Health Certificate™ på sølv niveau (standardversion 4.0). C2C Certified Material Health Certificate™ er en verifikation af sundheden og sikkerheden af et produkts sammensætning ved hjælp af Material Health-kravene i Cradle-to-Cradle Certified Product Standard.



Miljøpåvirkning

	kg CO ₂ equiv/m ²
Solo Square	9,37

Livscyklusstadier A1 til C4 fra EPD, i overensstemmelse med ISO 14025 / EN 15804



Circularity

Mindste indhold af genbrugsmateriale	57%
Genanvendelighed	Fuldt genanvendeligt



Brandsikkerhed

Land	Fire standard	Klasse
Europa	EN 13501-1	A2-s1,d0

Kernen af glasuld er testet og klassificeret som ikke-brændbar i henhold til EN ISO 1182.



Fugtbestandighed

Klasse C, relativ fugtighed 95% og 30° C, i henhold til EN 13964: 2014



Visuelt udseende

White Frost, nærmeste NCS-farveprøve S 0500-N, 85% lysreflektion. Glans < 1.



Rengøring

Tåler daglig støvsugning og aftørring, samt ugentlig våd aftørring med klud.



Tilgængelighed

Panelerne er demonterbare.



Montage

Monteres i henhold til montageanvisning, installationsguide og CAD-tegninger. Information vedrørende min. total konstruktionshøjde, se Mængdespecifikation.



System vægt

	kg/m ²
Solo Square	4,6
Solo Freedom	4,6

Vægt oplysninger er vejledende og kan variere.



Mekaniske egenskaber

Panelet tåler både punktbelastninger og fordelt belastning. Se Funktionskrav - mekaniske egenskaber på www.ecophon.dk



CE

Ecophon loftsystemer er CE-mærket i henhold til den europæiske harmoniserede standard EN 13964: 2014. CE-mærkede byggevarer er omfattet af en DOP (Declaration of Performance), som gør det muligt for kunder og brugere at sammenligne de tilgængelige produkter på det europæiske marked.

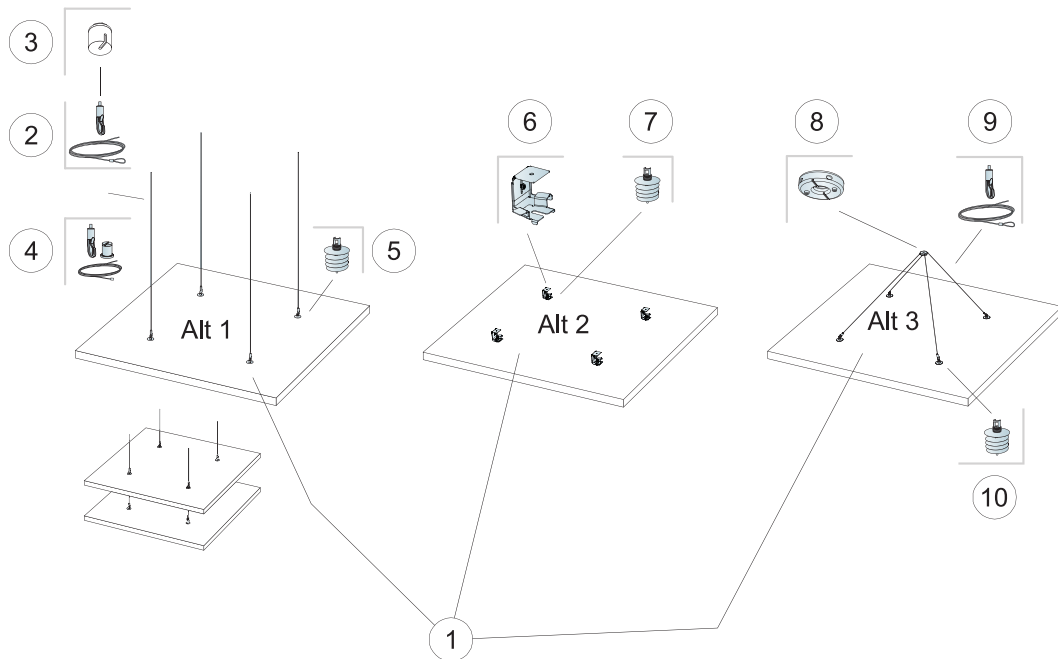

© Saint-Gobain Ecophon AB

MÆNGDESPECIFIKATION (EKSKLUSIV SPILD)

		Størrelse, mm
		1200x1200
1	Solo Square	1,44m ² /panel
2	Connect justerbar wire (Alt 1)	4/panel
3	Connect Dækkop (Alt.1, Valgfri)	4/panel
4	Connect justerbar wiresæt (Alt.1, Valgfri)	4/panel
5	Connect absorbent anker (Alt 1)	4/panel
6	Connect absorbent ophæng (Alt. 2)	4/panel
7	Connect absorbent anker (Alt 2)	4/panel
8	Connect centerophæng (Alt. 3)	1/panel
9	Connect justerbar wire (Alt 3)	2/panel
10	Connect absorbent anker (Alt 3)	4/panel
Δ Min. total konstruktionshøjde: Δ1 140 mm / Δ2 90 mm / Δ3 500 mm		-

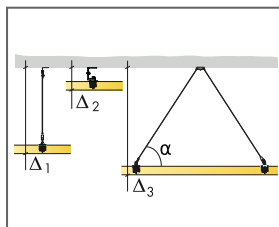

Se mængdespecifikation

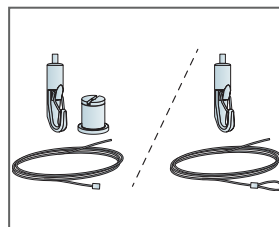

To typer af justerbar wire

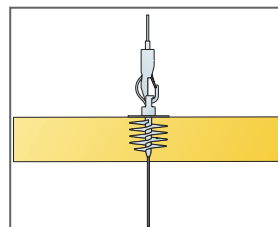

Paneler kan ophænges under hinanden

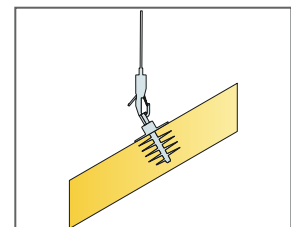

Paneler kan monteres i skrå vinkler.

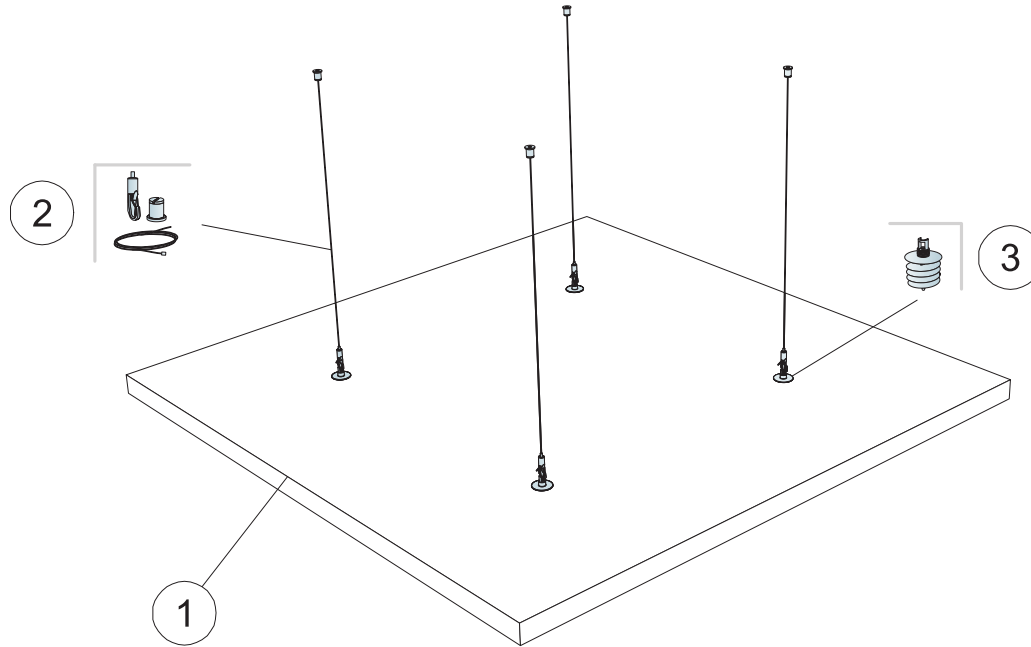

MÆNGDESPECIFIKATION (EKSKLUSIV SPILD)

	Størrelse, mm
	1200x1200
1 Solo Square Kit	1,44m ² /panel
2 Connect justerbar wire sæt 1500mm (inkluderet)	-
3 Connect absorbent-anker (inkluderet)	-
Δ Min. total konstruktionshøjde: Δ 140 mm	-
Ved montage af Connect absorbent-anker, anvend Connect absorbent-anker bits.	-

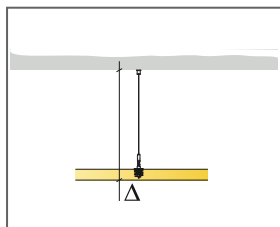

Se mængdespecifikation

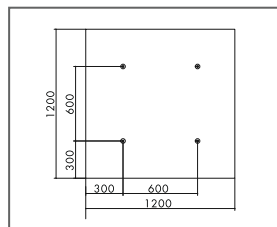

Ophæng med absorbent-anker, format 1200 x 1200

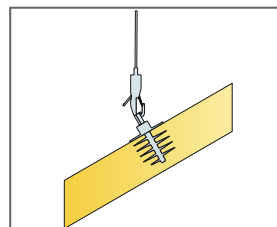

Paneler kan monteres i skrå vinkler.

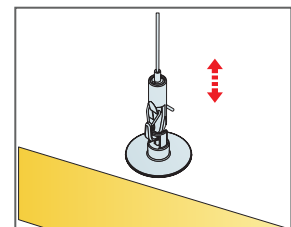

Let justerbar nedhængning med Connect justerbar wire

Ecophon Solo™ Rectangle

Ecophon Solo™ Rectangle er en frithængende enhed, der giver mange fantastiske designmuligheder. Tre forskellige ophængssystemer gør det muligt at skabe flere lag og vinkler. Produktet er velegnet, når rummets volumen skal bevares, eller når det ikke er muligt at montere et heldækkende loft.



M30 Achtheden, Oisterwijk, Netherlands

FORMATER

	Størrelse, mm	1200x600	1800x1200	2400x600	2400x1200	3000x1200
	Speciel montage	•	•	•	•	•
	Tykkelse [Tk.]	40	40	40	40	40
	Montageanvisning	M637	M404, M506	M405	M406, M407, M506	M408

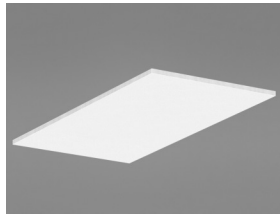

Solo Rectangle

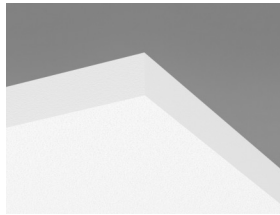

Solo panel

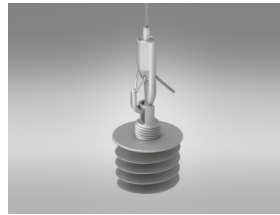

Nedhængning med Connect justerbar wire og Connect absorber-anker



Nedhængning med Connect absorber ophæng og Connect absorber-anker

Akustik



Værdierne i diagrammet refererer til en enkelt enhed. Hvis enheden placeres i en klynge med afstande mellem enhederne på under 0,5 meter, bliver A_{eq} pr. enhed let reduceret.

Lydabsorption:

Testresultater i henhold til EN ISO 354.

A_{avr} , ækvivalent absorptionsareal pr. enhed (m^2 sabin)

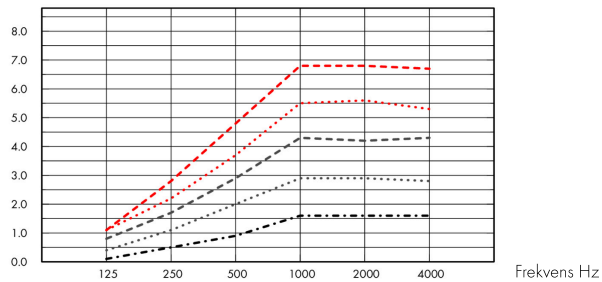

- Solo Rectangle 2400x1200, 1000 mm o.d.s.
 - Solo Rectangle 1800x1200, 1000 mm o.d.s.
 - Solo Rectangle 2400x600, 1000 mm o.d.s.
 - Solo Rectangle 3000x1200, 1000 mm o.d.s.
 - Solo Rectangle 1200x600, 1000 mm o.d.s.
- o.d.s = t_{kh} = total konstruktionshøjde

	Tk. mm	t _{kh} mm	A_{eq} ækvivalent absorptionsareal pr. enhed (m^2 sabin)					
			125 Hz	250 Hz	500 Hz	1000 Hz	2000 Hz	4000 Hz
2400x1200	40	200	1.3	2.8	3.5	4.1	4.1	3.9
2400x1200	40	400	1.2	2.4	3.3	4.7	4.9	4.7
2400x1200	40	1000	1.1	2.2	3.7	5.5	5.6	5.3
1800x1200	40	200	0.6	2.0	2.9	3.4	3.3	3.1
1800x1200	40	400	0.8	1.9	2.6	3.7	3.7	3.6
1800x1200	40	1000	0.8	1.7	2.9	4.3	4.2	4.3
2400x600	40	200	0.5	1.4	2.0	2.4	2.3	2.3
2400x600	40	400	0.4	1.2	1.8	2.6	2.7	2.7
2400x600	40	1000	0.4	1.1	2.0	2.9	2.9	2.8
3000x1200	40	200	1.1	3.3	4.4	5.1	5.1	5.0
3000x1200	40	400	1.2	3.0	4.2	5.8	5.8	5.7
3000x1200	40	1000	1.1	2.8	4.8	6.8	6.8	6.7
1200x600	40	200	0.1	0.7	1.0	1.3	1.3	1.4
1200x600	40	400	0.2	0.5	0.9	1.4	1.5	1.6
1200x600	40	1000	0.1	0.5	0.9	1.6	1.6	1.6

Indeklima



Certifikat / Label

Eurofins Indoor Air Comfort®

Fransk VOC

IAC Gold

A+





Cradle to Cradle Certified®



Dette produkt er Cradle to Cradle Certificeret® på bronze niveau (version 4.0).



Material Health



Dette produkt har modtaget et C2C Certified Material Health Certificate™ på sølv niveau (standardversion 4.0). C2C Certified Material Health Certificate™ er en verifikation af sundheden og sikkerheden af et produkts sammensætning ved hjælp af Material Health-kravene i Cradle-to-Cradle Certified Product Standard.



Miljøpåvirkning

kg CO ₂ equiv/m ²		Livscyklusstadier A1 til C4 fra EPD, i overensstemmelse med ISO 14025 / EN 15804
Solo Rectangle	9,12	



Circularity

Mindste indhold af genbrugsmateriale	57%
Genanvendelighed	Fuldt genanvendeligt



Brandsikkerhed

Land	Fire standard	Klasse
Europa	EN 13501-1	A2-s1,d0

Kernen af glasuld er testet og klassificeret som ikke-brændbar i henhold til EN ISO 1182.



Fugtbestandighed

Klasse C, relativ fugtighed 95% og 30° C, i henhold til EN 13964: 2014



Visuelt udseende

White Frost, nærmeste NCS-farveprøve S 0500-N, 85% lysreflektion. Glans < 1.



Rengøring

Tåler daglig støvsugning og aftørring, samt ugentlig vådaftørring med klud.



Tilgængelighed

Panelerne er demonterbare.



Montage

Monteres i henhold til montageanvisning, installationsguide og CAD-tegninger. Information vedrørende min. total konstruktionshøjde, se Mængdespecifikation.



System vægt

	kg/m ²
Solo Rectangle	4,7

Vægt oplysninger er vejledende og kan variere.



Mekaniske egenskaber

Panelet tåler både punktbelastninger og fordelt belastning. Se Funktionskrav - mekaniske egenskaber på www.ecophon.dk



CE

Ecophon loftsystemer er CE-mærket i henhold til den europæiske harmoniserede standard EN13964: 2014. CE-mærkede byggevarer er omfattet af en DOP (Declaration of Performance), som gør det muligt for kunder og brugere at sammenligne de tilgængelige produkter på det europæiske marked.

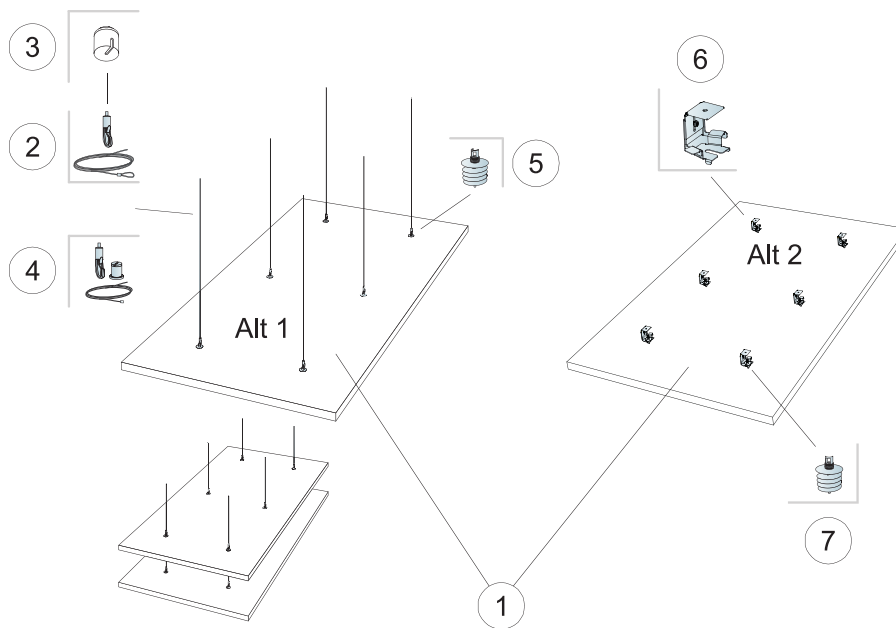

© Saint-Gobain Ecophon AB

MÆNGDESPECIFIKATION (EKSKLUSIV SPILD)

		Størrelse, mm
		1800x1200
1	Solo Rectangle	2,16m ² /panel
2	Connect justerbar wire (Alt 1)	6/panel
3	Connect Dækkop (Alt.1, Valgfri)	6/panel
4	Connect justerbar wiressæt (Alt.1, Valgfri)	6/panel
5	Connect absorberet anker (Alt 1)	6/panel
6	Connect absorberet ophæng (Alt. 2)	6/panel
7	Connect absorberet anker (Alt 2)	6/panel
Δ Min. total konstruktionshøjde: Δ1 140 mm / Δ2 90 mm		-

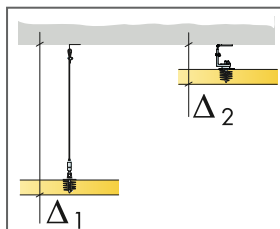

Se materialespecifikation

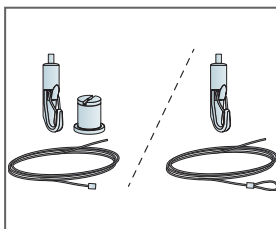

To typer af justerbar wire

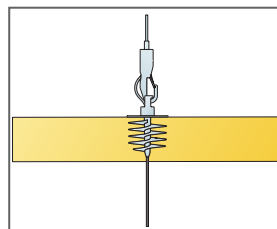

Paneler kan ophænges under hinanden

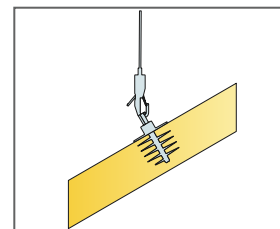

Paneler kan monteres i skrå vinkler.

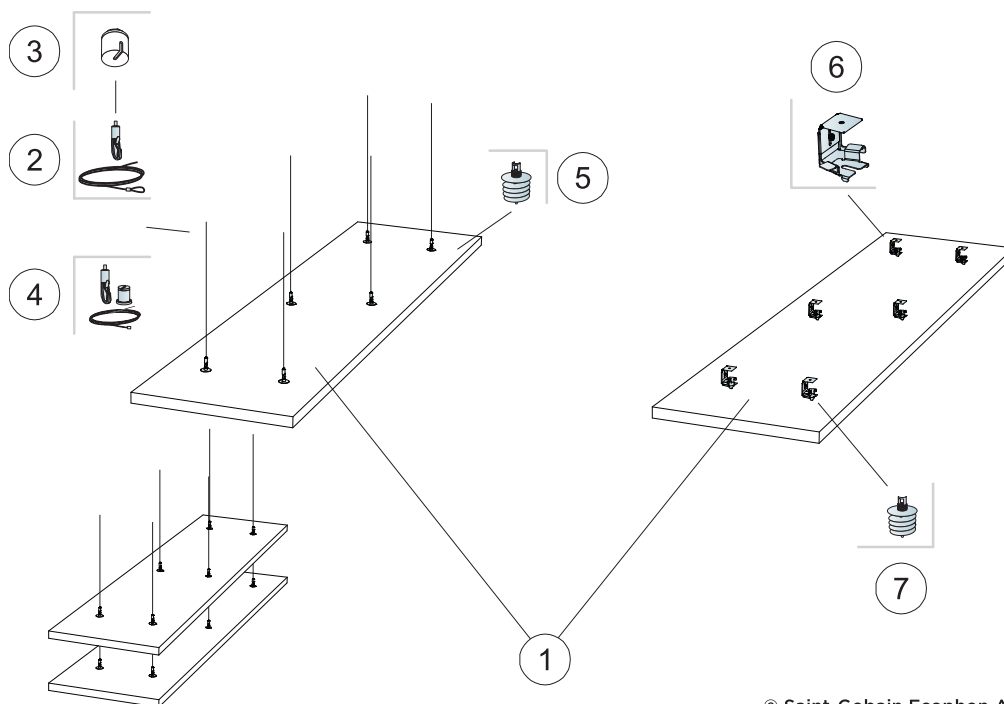

© Saint-Gobain Ecophon AB

MÆNGDESPECIFIKATION (EKSKLUSIV SPILD)

		Størrelse, mm
		2400x600
1	Solo Rectangle	1,44m ² /panel
2	Connect justerbar wire (Alt 1)	6/panel
3	Connect Dækkop (Alt. 1, Valgfri)	6/panel
4	Connect justerbar viresæt (Alt. 1, Valgfri)	6/panel
5	Connect absorberent anker (Alt 1)	6/panel
6	Connect absorberent ophæng (Alt. 2)	6/panel
7	Connect absorberent anker (Alt 2)	6/panel
Δ Min. total konstruktionshøjde: Δ1 140 mm / Δ2 90 mm		-

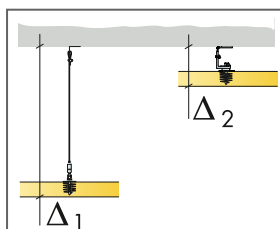

Se materialespecifikation

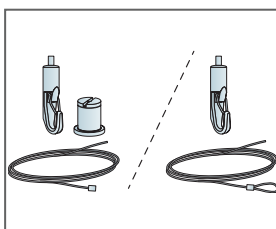

To typer af justerbar wire

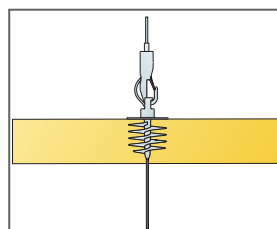

Paneler kan ophænges under hinanden

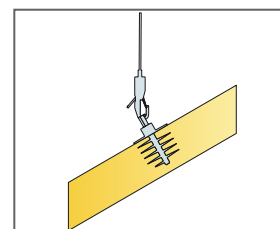

Paneler kan monteres i skrå vinkler.

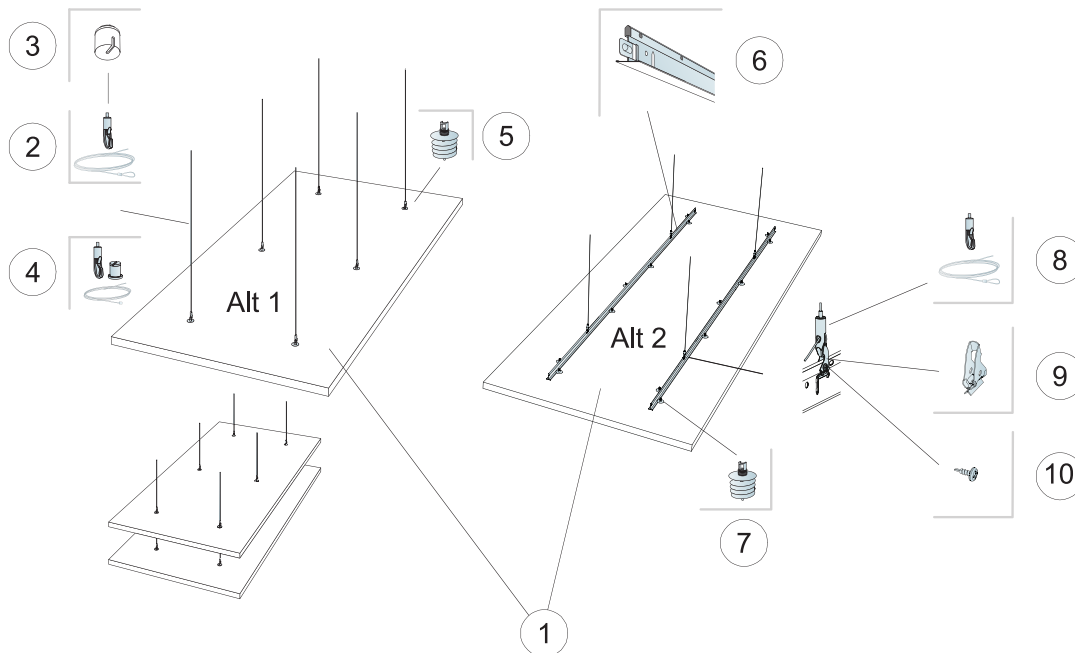

© Saint-Gobain Ecophon AB

MÆNGDESPECIFIKATION (EKSKLUSIV SPILD)

		Størrelse, mm
		2400x1200
1	Solo Rectangle	2,88m ² /panel
2	Connect justerbar wire (Alt 1)	6/panel
3	Connect Dækkop (Alt. 1, Valgfri)	6/panel
4	Connect justerbar wiresæt (Alt. 1, Valgfri)	6/panel
5	Connect absorbt anker (Alt 1)	6/panel
6	Connect T24 hovedprofil (Alt. 2)	2/panel
7	Connect absorbt anker (Alt. 2)	14/panel
8	Connect justerbar wire (Alt. 2)	4/panel
9	Connect stropfæste (Alt. 2)	4/panel
10	Connect montageskrue BR (Alt 2)	4/panel
Δ Min. total konstruktionshøjde: Δ1 140 mm / Δ2 200 mm		-

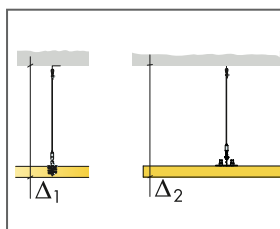

Se materialespecifikation

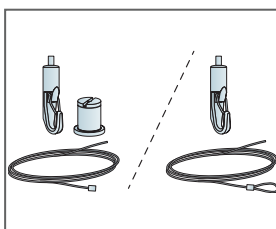

To typer af justerbar wire

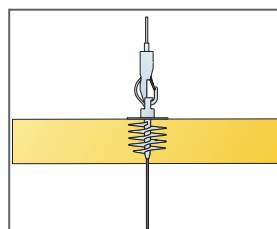

Paneler kan ophænges under hinanden

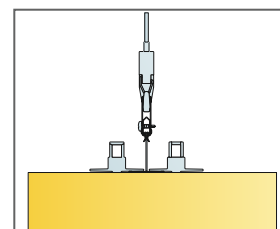

Montage med T24 Hovedprofil

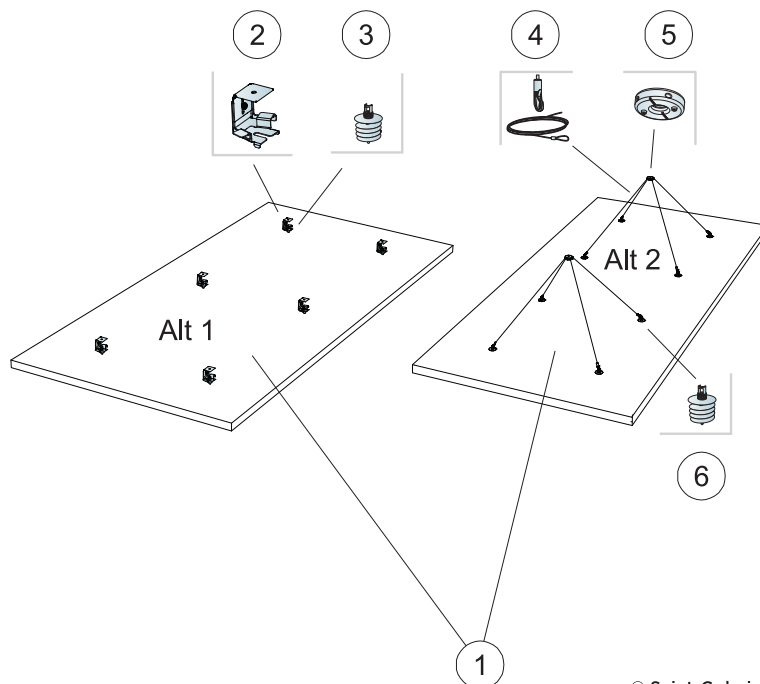

© Saint-Gobain Ecophon AB

MÆNGDESPECIFIKATION (EKSKLUSIV SPILD)

		Størrelse, mm
		2400x1200
1	Solo Rectangle	2,88m ² /panel
2	Connect absorbent ophæng (Alt. 1)	6/panel
3	Connect absorbent anker (Alt. 1)	6/panel
4	Connect justerbar wire (Alt. 2)	4/panel
5	Connect centerophæng (Alt. 2)	2/panel
6	Connect absorbent anker (Alt. 2)	8/panel
Δ Min. total konstruktionshøjde: Δ1 90 mm / Δ2 500 mm		-

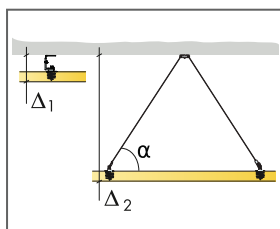

Se materialespecifikation

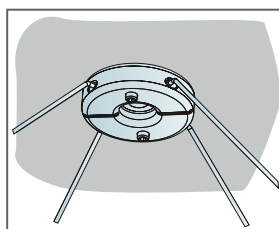

Detalje af centerophæng

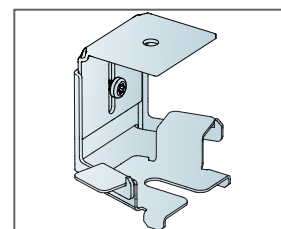

Absorbent ophæng. Total konstruktionshøjde 90-130 mm.

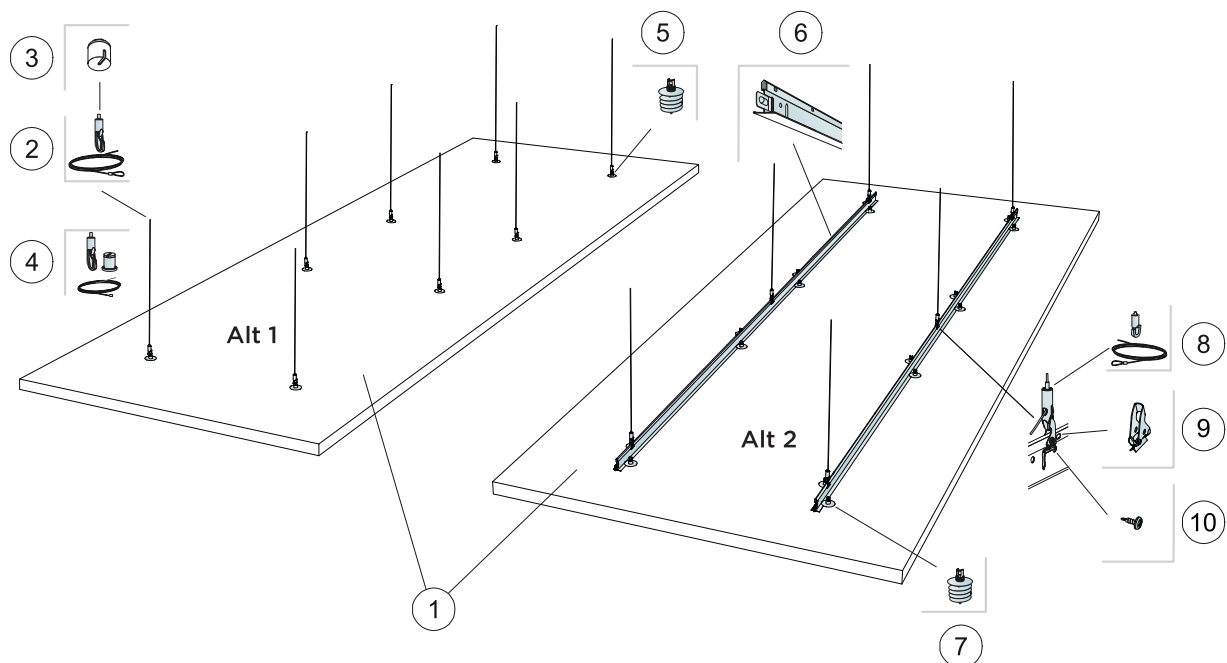

© Saint-Gobain Ecophon AB

MÆNGDESPECIFIKATION (EKSKLUSIV SPILD)

		Størrelse, mm
		3000x1200
1	Solo Rectangle	3,6m ² /panel
2	Connect justerbar wire (Alt 1)	8/panel
3	Connect Dækkop (Valgfri)	8/panel
4	Connect justerbar wiresæt (Valgfri)	8/panel
5	Connect absorbt anker (Alt 1)	8/panel
6	Connect T24 hovedprofil (Alt 2)	2/panel
7	Connect absorbt anker (Alt 2)	16/panel
8	Connect justerbar wire (Alt 2)	6/panel
9	Connect stropfæste (Alt 2)	6/panel
10	Connect montageskrue BR (Alt 2)	6/panel
Δ Min. total konstruktionshøjde: Δ1 140 mm / Δ2 200 mm		-

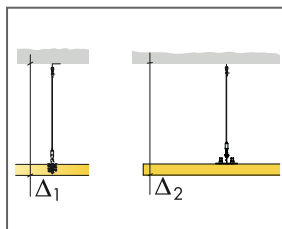

Se materialespecifikation

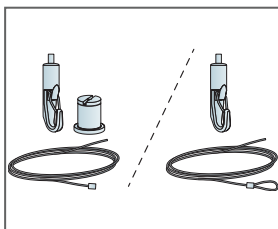

To typer af justerbar wire

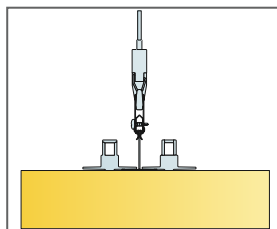

Montage med T24 Hovedprofil

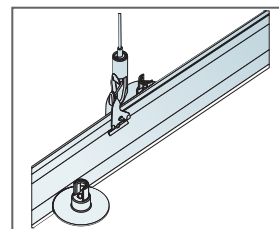

Montage af stropfæste

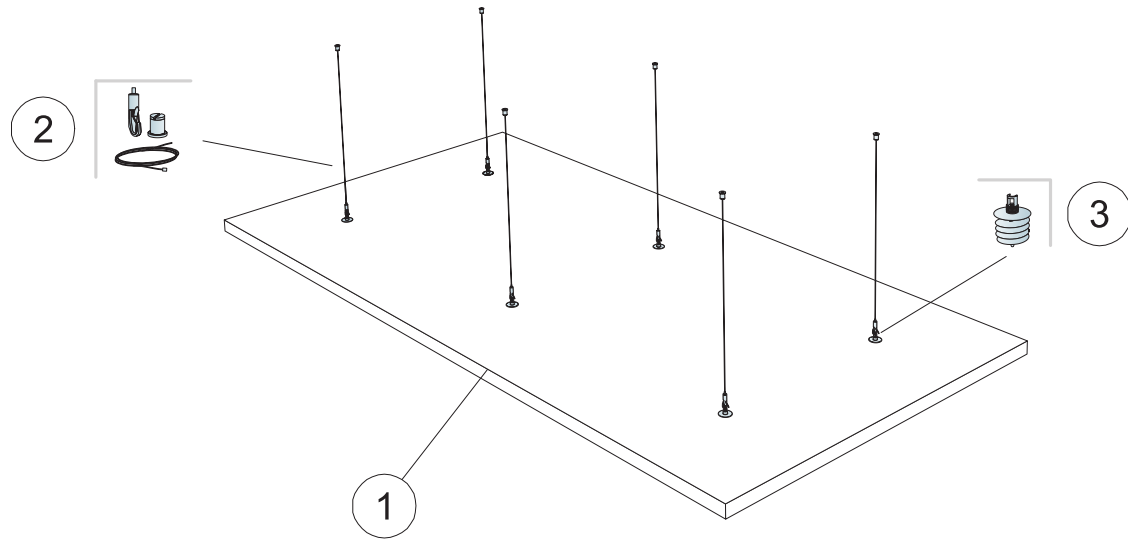

MÆNGDESPECIFIKATION (EKSKLUSIV SPILD)

	Størrelse, mm	
	1800x1200	2400x1200
1 Solo Rectangle Kit	2,16m ² /panel	2,88m ² /panel
2 Connect justerbar wire sæt 1.500mm (inkluderet)	-	-
3 Connect absorberanker (inkluderet)	-	-
Δ Min. total konstruktionshøjde: Δ 140 mm	-	-
Ved montage af Connect absorberanker, anvend Connect absorberanker bits.	-	-

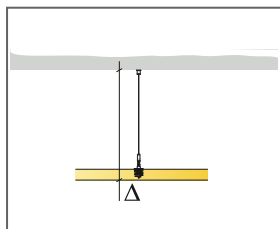

Se mængdespecifikation

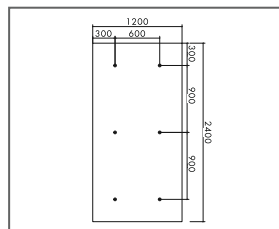

Ophængt med absorberanker, format 2400 x 1200

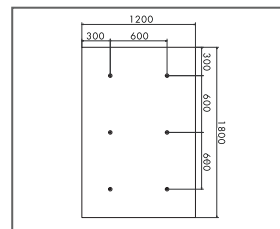

Ophængt med absorberanker, format 1800 x 1200

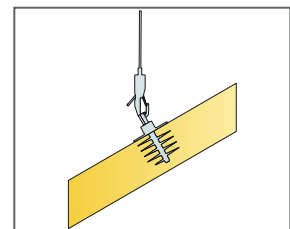

Paneler kan monteres i skrå vinkler.

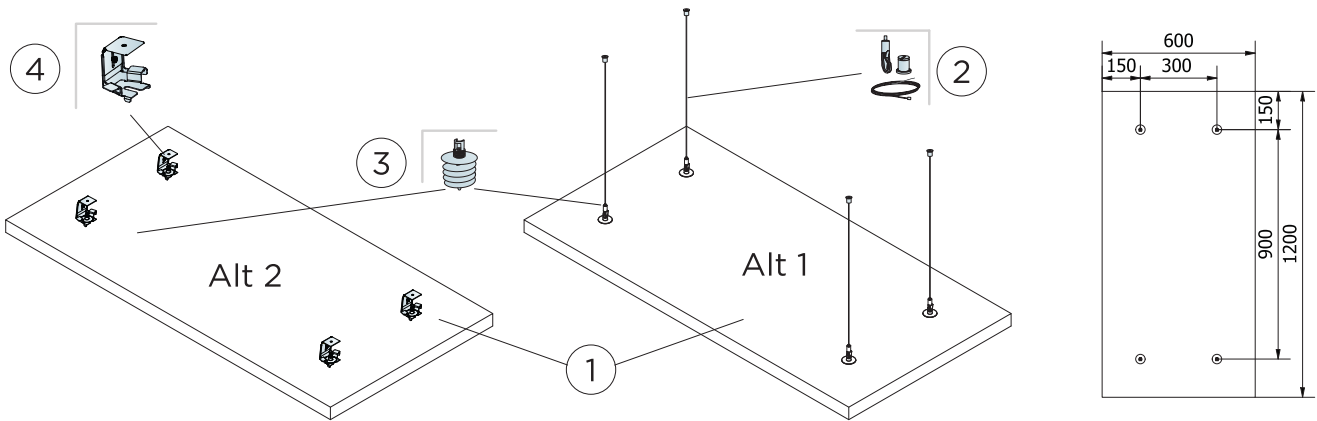

MÆNGDESPECIFIKATION (EKSKLUSIV SPILD)

	Størrelse, mm
	1200x600
1 Solo Rectangle	0,72m ² /panel
2 Connect justerbar wiresæt (Alt 1)	4/panel
3 Connect absorberent anker	4/panel
4 Connect absorberent ophæng (Alt 2)	4/panel
Δ Min. total konstruktionshøjde: Δ 140 mm	-
Ved montage af Connect absorberent-anker, anvend Connect absorberent-anker bits.	-

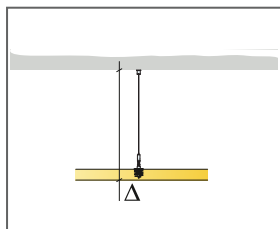

Se mængdespecifikation

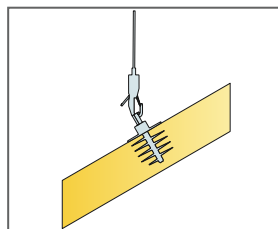

Paneler kan monteres i skrå vinkler.

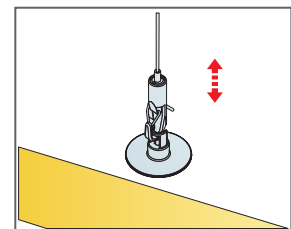

Let justerbar nedhængning med Connect justerbar wire

Ecophon Solo™ Circle

Ecophon Solo™ Circle er en frithængende enhed, der giver mange fantastiske designmuligheder. Tre forskellige ophængssystemer gør det muligt at skabe flere lag og vinkler. Produktet er velegnet, når rummets volumen skal bevares, eller når det ikke er muligt at montere et heldækkende loft.



Asia Zereca, Warsaw, Poland

FORMATER

 Størrelse, mm	Ø800	Ø1200
Speciel montage	•	•
Tykkelse (Tk.)	40	40
Montageanvisning	M411	M410



Solo Circle



Nedhængning med Connect justerbar wire og Connect absorber-anker



Nedhængning med Connect absorber ophæng og Connect absorber-anker

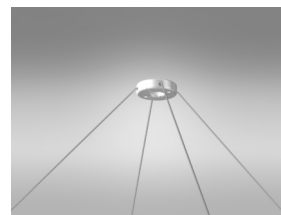

Akustik

Værdierne i diagrammet henviser til en enkelt enhed. Hvis enhederne arrangeres i en klynge med afstande på mindre en 0,5 meter, bliver Aeq pr. enhed let reduceret.

Lydabsorption:

Testresultater i henhold til EN ISO 354.

A_{avr} , ækvivalent absorptionsareal pr. enhed (m^2 sabin)

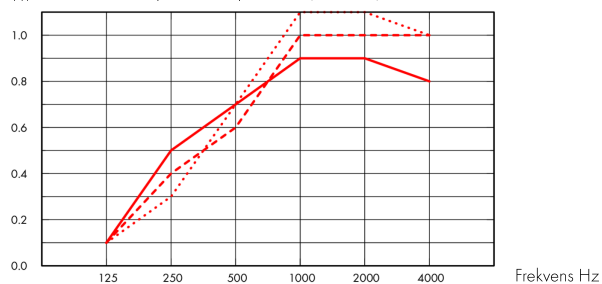

- Solo Circle Ø800, 200 mm o.d.s.
 - - - Solo Circle Ø800, 400 mm o.d.s.
 - ... Solo Circle Ø800, 1000 mm o.d.s.
- o.d.s = t_{kh} = total konstruktionshøjde

A_{eq} , ækvivalent absorptionsareal pr. enhed (m^2 sabin)

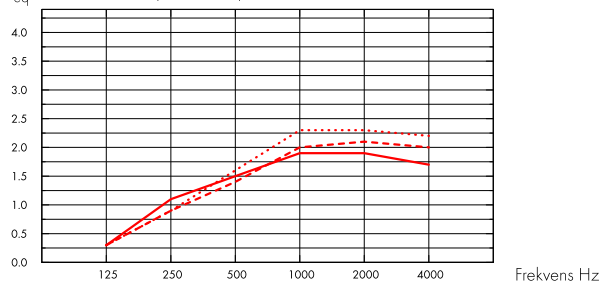

- Solo Circle Ø1200, 200 mm o.d.s.
 - - - Solo Circle Ø1200, 400 mm o.d.s.
 - ... Solo Circle Ø1200, 1000 mm o.d.s.
- o.d.s = t_{kh} = total konstruktionshøjde

	Tk. mm	t _{kh} mm	A_{eq} , ækvivalent absorptionsareal pr. enhed (m^2 sabin)					
			125 Hz	250 Hz	500 Hz	1000 Hz	2000 Hz	4000 Hz
Ø800	40	200	0.1	0.5	0.7	0.9	0.9	0.8
Ø800	40	400	0.1	0.4	0.6	1.0	1.0	1.0
Ø800	40	1000	0.1	0.3	0.7	1.1	1.1	1.0

	Tk. mm	t _{kh} mm	A_{eq} , ækvivalent absorptionsareal pr. enhed (m^2 sabin)					
			125 Hz	250 Hz	500 Hz	1000 Hz	2000 Hz	4000 Hz
Ø1200	40	200	0.3	1.1	1.5	1.9	1.9	1.7
Ø1200	40	400	0.3	0.9	1.4	2.0	2.1	2.0
Ø1200	40	1000	0.3	0.9	1.6	2.3	2.3	2.2



Indeklima

Certifikat / Label

Eurofins Indoor Air Comfort®	IAC Gold
Fransk VOC	A+



Cradle to Cradle Certified®



Dette produkt er Cradle to Cradle Certificeret® på bronze niveau (version 4.0).



Material Health



Dette produkt har modtaget et C2C Certified Material Health Certificate™ på sølv niveau (standardversion 4.0). C2C Certified Material Health Certificate™ er en verifikation af sundheden og sikkerheden af et produkts sammensætning ved hjælp af Material Health-kravene i Cradle-to-Cradle Certified Product Standard.



Miljøpåvirkning

	kg CO ₂ equiv/m ²
Solo Circle	10,35

Livscyklusstadier A1 til C4 fra EPD, i overensstemmelse med ISO 14025 / EN 15804



Circularity

Mindste indhold af genbrugsmateriale	57%
Genanvendelighed	Fuldt genanvendeligt



Brandsikkerhed

Land	Fire standard	Klasse
Europa	EN 13501-1	A2-s1,d0

Kernen af glasuld er testet og klassificeret som ikke-brændbar i henhold til EN ISO 1182.



Fugtbestandighed

Klasse C, relativ fugtighed 95% og 30° C, i henhold til EN 13964: 2014



Visuelt udseende

White Frost, nærmeste NCS-farveprøve S 0500-N, 85% lysreflektion. Glans < 1.



Rengøring

Tåler daglig støvsugning og aftørring, samt ugentlig vådaftørring med klud.



Tilgængelighed

Panelerne er demonterbare.



Montage

Monteres i henhold til montageanvisning, installationsguide og CAD-tegninger. Information vedrørende min. total konstruktionshøjde, se Mængdespecifikation.



System vægt

	kg/m ²	Vægt oplysninger er vejledende og kan variere.
Solo Circle	4,6	



Mekaniske egenskaber

Panelet tåler både punktbelastninger og fordelt belastning. Se Funktionskrav - mekaniske egenskaber på www.ecophon.dk



CE

Ecophon loftsystemer er CE-mærket i henhold til den europæiske harmoniserede standard EN 13964: 2014. CE-mærkede byggevarer er omfattet af en DOP (Declaration of Performance), som gør det muligt for kunder og brugere at sammenligne de tilgængelige produkter på det europæiske marked.

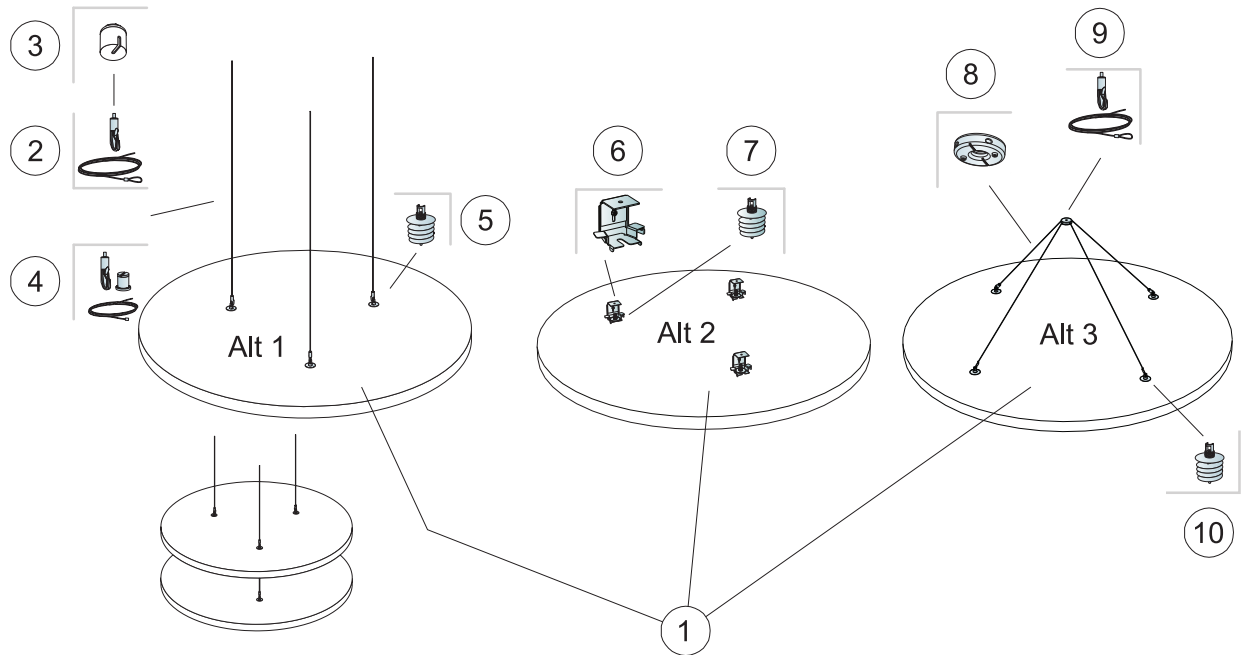

© Saint-Gobain Ecophon AB

MÆNGDESPECIFIKATION (EKSKLUSIV SPILD)

		Størrelse, mm
		Ø1200
1	Solo Circle	1,13m ² /panel
2	Connect justerbar wire (Alt 1)	3/panel
3	Connect Dækkop (Alt.1, Valgfri)	3/panel
4	Connect justerbar wiresæt (Alt.1, Valgfri)	3/panel
5	Connect absorbtent anker (Alt 1)	3/panel
6	Connect absorbtent ophæng (Alt. 2)	3/panel
7	Connect absorbtent anker (Alt 2)	3/panel
8	Connect centerophæng (Alt. 3)	1/panel
9	Connect justerbar wire (Alt 3)	2/panel
10	Connect absorbtent anker (Alt 3)	4/panel
Δ Min. total konstruktionshøjde: Δ1 140 mm / Δ2 90 mm / Δ3 500 mm		-

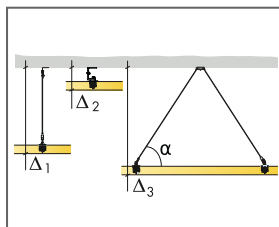

Se mængdespecifikation

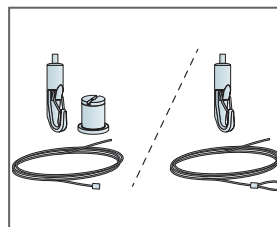

To typer af justerbar wire

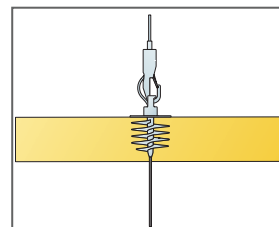

Paneler kan ophænges under hinanden

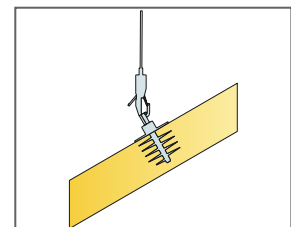

Paneler kan monteres i skrå vinkler.

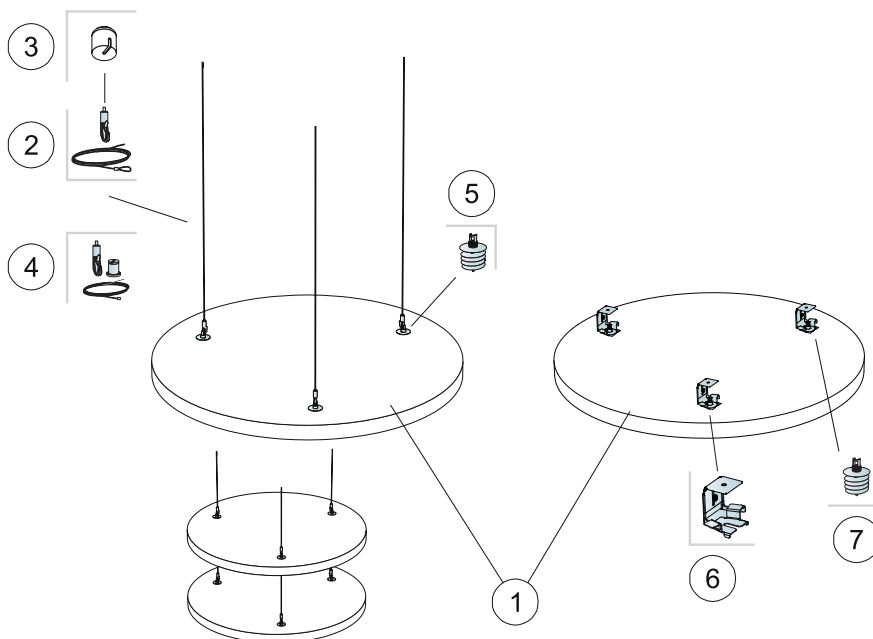

© Saint-Gobain Ecophon AB

MÆNGDESPECIFIKATION (EKSKLUSIV SPILD)

		Størrelse, mm
		Ø800
1	Solo Circle	0,5m ² /panel
2	Connect justerbar wire (Alt 1)	3/panel
3	Connect Dækkop (Alt.1, Valgfri)	3/panel
4	Connect justerbar wiressæt (Alt.1, Valgfri)	3/panel
5	Connect absorbent anker (Alt 1)	3/panel
6	Connect absorbent ophæng (Alt. 2)	3/panel
7	Connect absorbent anker (Alt 2)	3/panel
Δ Min. total konstruktionshøjde: Δ1 140 mm / Δ2 90 mm		-

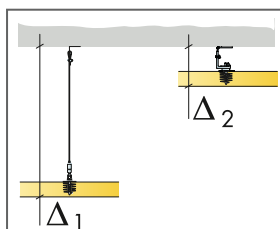

Se materialespecifikation

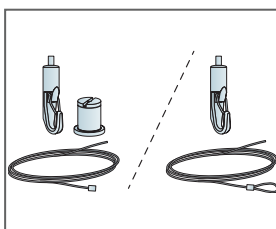

To typer af justerbar wire

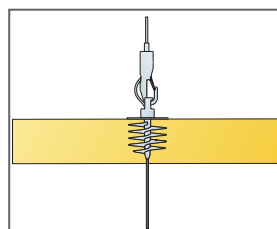

Paneler kan ophænges under hinanden

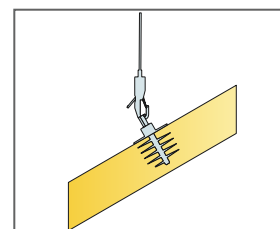

Paneler kan monteres i skrå vinkler.

Ecophon Solo™ Circle XL

Ecophon Solo™ Circle XL er en stor frithængende enhed med to halvcirkler, der giver mange forskellige designmuligheder. Til formål, hvor det ikke er muligt at montere et heldækkende loft



FORMATER



Størrelse, mm	XL Ø1600
Speciel montage	•
Tykkelse (Tk.)	40
Montageanvisning	M290

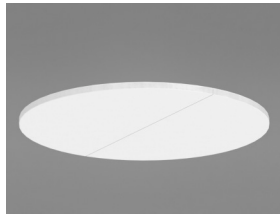

Solo Circle XL

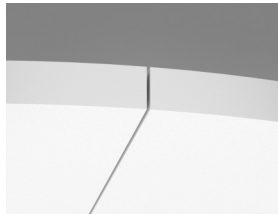

Solo Circle XL panel

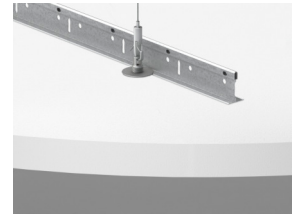
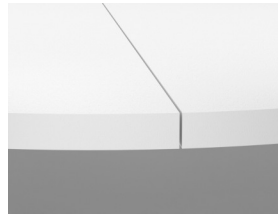

Solo Circle XL monteret med Connect absorberet anker

Akustik



Værdierne i diagrammet refererer til en enkelt enhed. Hvis enheden placeres i en klynge med afstande på under 0,5 meter, vil Aeq pr. enhed blive let reduceret.

Lydabsorption:

Testresultater i henhold til EN ISO 354.

A_{eq} ækvivalent absorptionsareal pr. enhed (m² sabin)

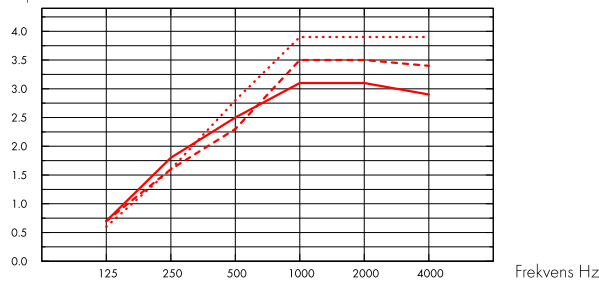

Tk. mm	tkh mm	A_{eq} ækvivalent absorptionsareal pr. enhed (m ² sabin)					
		125 Hz	250 Hz	500 Hz	1000 Hz	2000 Hz	4000 Hz
40	200	0.7	1.8	2.5	3.1	3.1	2.9
40	400	0.7	1.6	2.3	3.5	3.5	3.4
40	1000	0.6	1.6	2.8	3.9	3.9	3.9



Indeklima

Certifikat / Label

Eurofins Indoor Air Comfort®

IAC Gold

Fransk VOC

A+



Cradle to Cradle Certified®



Dette produkt er Cradle to Cradle Certificeret® på bronze niveau (version 4.0).



Material Health



Dette produkt har modtaget et C2C Certified Material Health Certificate™ på sølv niveau (standardversion 4.0). C2C Certified Material Health Certificate™ er en verifikation af sundheden og sikkerheden af et produkts sammensætning ved hjælp af Material Health-kravene i Cradle-to-Cradle Certified Product Standard.



Miljøpåvirkning

kg CO₂ equiv/m²

Solo Circle

10,35

Livscyklusstadier A1 til C4 fra EPD, i overensstemmelse med ISO 14025 / EN 15804



Circularity

Mindste indhold af genbrugsmateriale	57%
Genanvendelighed	Fuldt genanvendeligt



Brandsikkerhed

Land	Fire standard	Klasse
Europa	EN 13501-1	A2-s1,d0

Kernen af glasuld er testet og klassificeret som ikke-brændbar i henhold til EN ISO 1182.



Fugtbestandighed

Klasse C, relativ fugtighed 95% og 30° C, i henhold til EN 13964: 2014



Visuelt udseende

White Frost, nærmeste NCS-farveprøve S 0500-N, 85% lysreflektion. Glans < 1.



Rengøring

Tåler daglig støvsugning og aftørring, samt ugentlig vådaftørring med klud.



Tilgængelighed

Panelerne er demonterbare.



Montage

Monteres i henhold til montageanvisning, installationsguide og CAD-tegninger. Information vedrørende min. total konstruktionshøjde, se Mængdespecifikation.



System vægt

	kg/m ²
Solo Circle XL	4,8

Vægt oplysninger er vejledende og kan variere.



Mekaniske egenskaber

Ingen yderligere belastning er tilladt.



CE

Ecophon loftsystemer er CE-mærket i henhold til den europæiske harmoniserede standard EN13964: 2014. CE-mærkede byggevarer er omfattet af en DOP (Declaration of Performance), som gør det muligt for kunder og brugere at sammenligne de tilgængelige produkter på det europæiske marked.

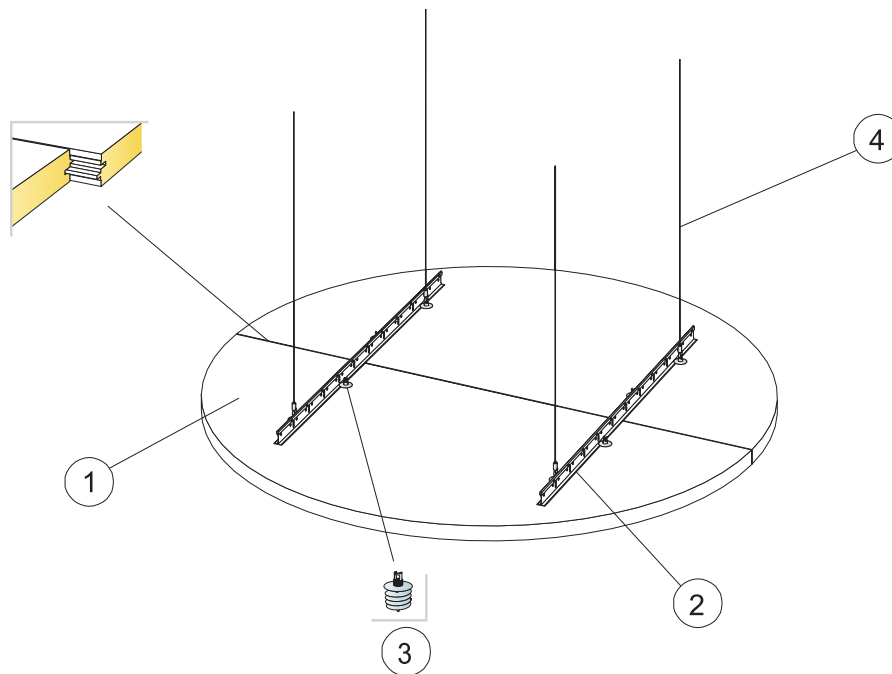

© Saint-Gobain Ecophon AB

MÆNGDESPECIFIKATION (EKSKLUSIV SPILD)

	Størrelse, mm
	Ø1600
1 Solo Circle XL	2,01 m ² /panel
2 Connect T24 hovedprofil	0,60/panel
3 Connect absorbent anker	8/panel
4 Connect justerbar wire	4/panel
Δ Min. total konstruktionshøjde: Δ 200 mm	-
Ved montage af Connect absorbent-anker, anvend Connect absorbent-anker bits.	-

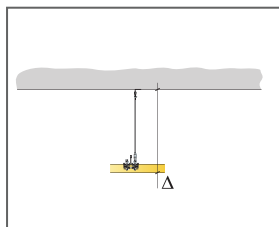

Se mængdespecifikation

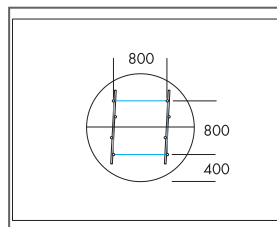

Nedhængning med Connect justerbar wire og Connect T24 hovedprofil

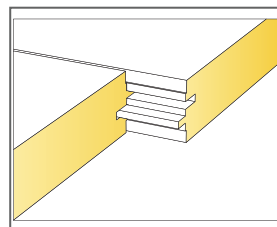

Møde mellem paneler

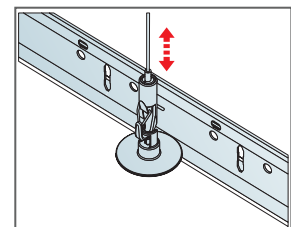

Let justerbar nedhængning med Connect justerbar wire

Ecophon Solo™ Cloud

Solo Cloud er en frithængende enhed, der tilbyder designmuligheder på højt niveau. Tre forskellige ophængssystemer giver mulighed for at skabe flere lag og vinkler. Velegnet, når rumvolumen skal opretholdes, eller når det ikke er muligt at montere et heldækkende loft.



Chelamco Arena, Belgium

FORMATER



Størrelse, mm	1200x553	2400x1106
Speciel montage	•	•
Tykkelse (Tk.)	40	40
Montageanvisning	M430	M430

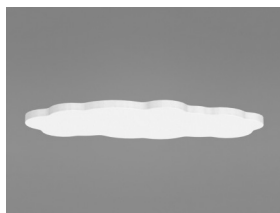

Solo Freedom formet som en sky



Nedhængning med Connect justerbar wire og Connect absorber-anker

Akustik



For akustiske data på panelet - se Solo Square og Rectangle



Cradle to Cradle Certified®



Dette produkt er Cradle to Cradle Certificeret® på bronze niveau (version 4.0).



Material Health



Dette produkt har modtaget et C2C Certified Material Health Certificate™ på sølv niveau (standardversion 4.0). C2C Certified Material Health Certificate™ er en verifikation af sundheden og sikkerheden af et produkts sammensætning ved hjælp af Material Health-kravene i Cradle-to-Cradle Certified Product Standard.



Miljøpåvirkning

	kg CO ₂ equiv/m ²	Livscyklusstadier A1 til C4 fra EPD, i overensstemmelse med ISO 14025 / EN 15804
Solo Freedom	8,41 (Solo Family EPD i overensstemmelse med ISO 14025 / EN 15804)	



Circularity

Mindste indhold af genbrugsmateriale	57%
Genanvendelighed	Fuldt genanvendeligt



Brandsikkerhed

Land	Fire standard	Klasse	Kernen af glasuld er testet og klassificeret som ikke-brændbar i henhold til EN ISO 1182.
Europa	EN 13501-1	A2-s1,d0	



Fugtbestandighed

Klasse C, relativ fugtighed 95% og 30° C, i henhold til EN 13964: 2014



Visuelt udseende

White Frost, nærmeste NCS-farveprøve S 0500-N, 85% lysreflektion. Glans < 1.



Rengøring

Tåler daglig støvsugning og aftørring, samt ugentlig vådftørring med klud.



Tilgængelighed

Panelerne er demonterbare.



Montage

Monteres i henhold til montageanvisning, installationsguide og CAD-tegninger. Information vedrørende min. total konstruktionshøjde, se Mængdespecifikation.



Mekaniske egenskaber

Panelet tåler både punktbelastninger og fordelt belastning. Se Funktionskrav - mekaniske egenskaber på www.ecophon.dk



CE

Ecophon loftsystemer er CE-mærket i henhold til den europæiske harmoniserede standard EN13964: 2014. CE-mærkede byggevarer er omfattet af en DOP (Declaration of Performance), som gør det muligt for kunder og brugere at sammenligne de tilgængelige produkter på det europæiske marked.

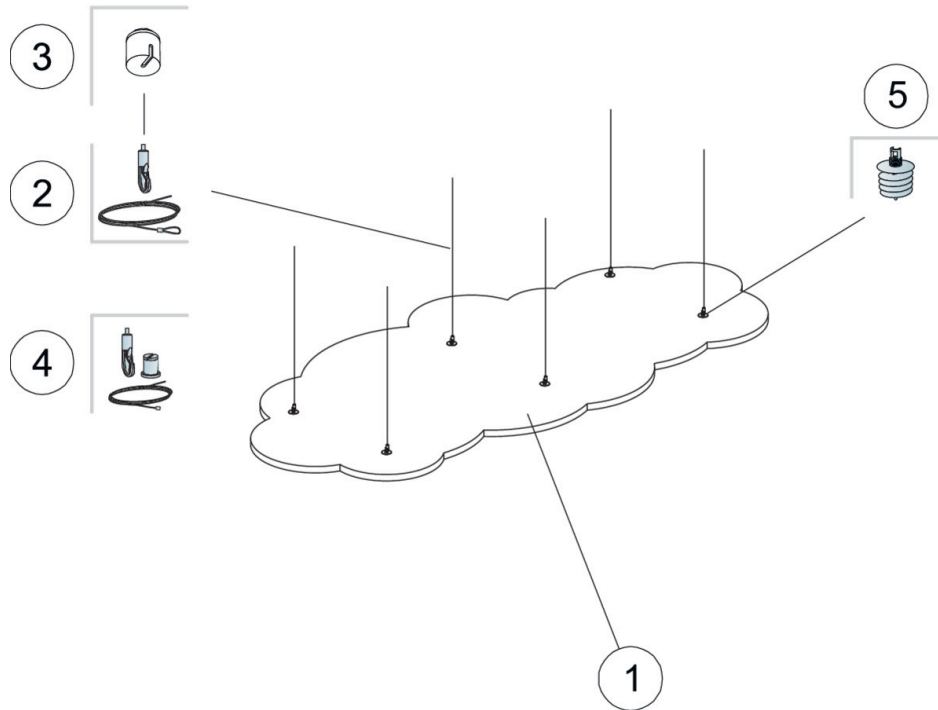

MÆNGDESPECIFIKATION (EKSKLUSIV SPILD)

		Størrelse, mm	
		1200x553	2400x1106
1	Solo Freedom	-	-
2	Connect justerbar wire	-	-
3	Connect Dækkop	-	-
4	Connect justerbar wiresæt (Alt, 1, Valgfri)	-	-
5	Connect absorbent anker	-	-
Δ Min. total konstruktionshøjde: 140 mm		-	-

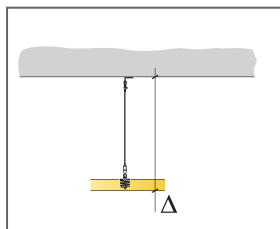

Se mængdespecifikation

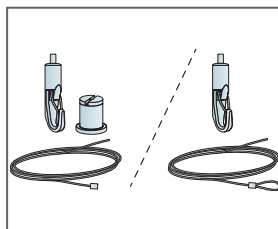

To typer af justerbar wire

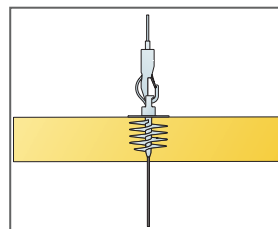

Paneler kan ophænges under hinanden

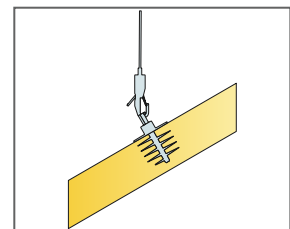

Paneler kan monteres i skrå vinkler.

Ecophon Solo™ Ellipse

Solo Ellipse er en frithængende enhed, der tilbyder designmuligheder på højt niveau. Tre forskellige ophængssystemer giver mulighed for at skabe flere lag og vinkler. Velegnet, når rumvolumen skal opretholdes, eller når det ikke er muligt at montere et heldækkende loft.



Chelamco Arena, Belgium

FORMATER



Størrelse, mm	2400x1000
Speciel montage	•
Tykkelse (Tk.)	40
Montageanvisning	M428

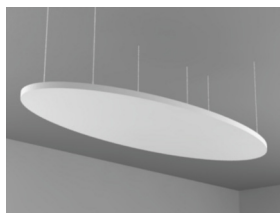

Frithængende panel formet som Elipse



Nedhængning med Connect justerbar wire og Connect absorber-anker

Akustik



Værdierne i diagrammet henviser til en enkelt enhed. Hvis enhederne placeres i en klynge med afstande på mindre end 0,5 meter, bliver A_{eq} pr. enhed let reduceret.

Lydabsorption:

Testresultat baseret på EN ISO 354.

A_{eq} ækvivalent absorptionsareal pr. enhed (m^2 sabin)

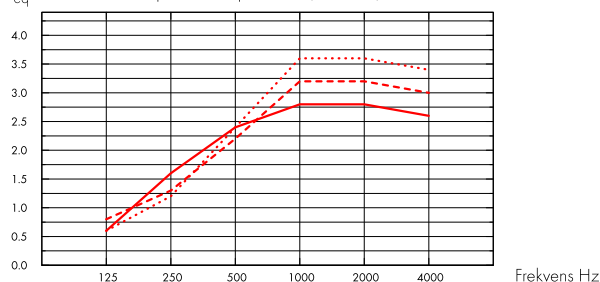

- Solo Ellipse 2400x1000, 200 mm o.d.s.
 - - - Solo Ellipse 2400x1000, 400 mm o.d.s.
 - ... Solo Ellipse 2400x1000, 1000 mm o.d.s.
- o.d.s = tkh = total konstruktionshøjde

Tk. mm	tkh mm	A_{eq} ækvivalent absorptionsareal pr. enhed (m^2 sabin)					
		125 Hz	250 Hz	500 Hz	1000 Hz	2000 Hz	4000 Hz
40	200	0.6	1.6	2.4	2.8	2.8	2.6
40	400	0.8	1.3	2.2	3.2	3.2	3.0
40	1000	0.6	1.2	2.4	3.6	3.6	3.4

Indeklima



Certifikat / Label

Eurofins Indoor Air Comfort®

IAC Gold

Fransk VOC

A+



Cradle to Cradle Certified®



Dette produkt er Cradle to Cradle Certificeret® på bronze niveau (version 4.0).



Material Health



Dette produkt har modtaget et C2C Certified Material Health Certificate™ på sølv niveau (standardversion 4.0). C2C Certified Material Health Certificate™ er en verifikation af sundheden og sikkerheden af et produkts sammensætning ved hjælp af Material Health-kravene i Cradle-to-Cradle Certified Product Standard.



Miljøpåvirkning

kg CO₂ equiv/m²

Solo
Freedom

8,41 (Solo Family EPD i overensstemmelse med ISO 14025 / EN 15804)

Livscyklusstadier A1 til C4 fra EPD, i overensstemmelse med ISO 14025 / EN 15804



Circularity

Mindste indhold af genbrugsmateriale	57%
Genanvendelighed	Fuldt genanvendeligt



Brandsikkerhed

Land	Fire standard	Klasse
Europa	EN 13501-1	A2-s1,d0

Kernen af glasuld er testet og klassificeret som ikke-brændbar i henhold til EN ISO 1182.



Fugtbestandighed

Klasse C, relativ fugtighed 95% og 30° C, i henhold til EN 13964: 2014



Visuelt udseende

White Frost, nærmeste NCS-farveprøve S 0500-N, 85% lysreflektion. Glans < 1.



Rengøring

Tåler daglig støvsugning og aftørring, samt ugentlig vådaftørring med klud.



Tilgængelighed

Panelerne er demonterbare.



Montage

Monteres i henhold til montageanvisning, installationsguide og CAD-tegninger. Information vedrørende min. total konstruktionshøjde, se Mængdespecifikation.



System vægt

	kg/m ²
Solo Ellipse	4,8

Vægt oplysninger er vejledende og kan variere.



Mekaniske egenskaber

Panelet tåler både punktbelastninger og fordelt belastning. Se Funktionskrav - mekaniske egenskaber på www.ecophon.dk



CE

Ecophon loftsystemer er CE-mærket i henhold til den europæiske harmoniserede standard EN 13964: 2014. CE-mærkede byggevarer er omfattet af en DOP (Declaration of Performance), som gør det muligt for kunder og brugere at sammenligne de tilgængelige produkter på det europæiske marked.

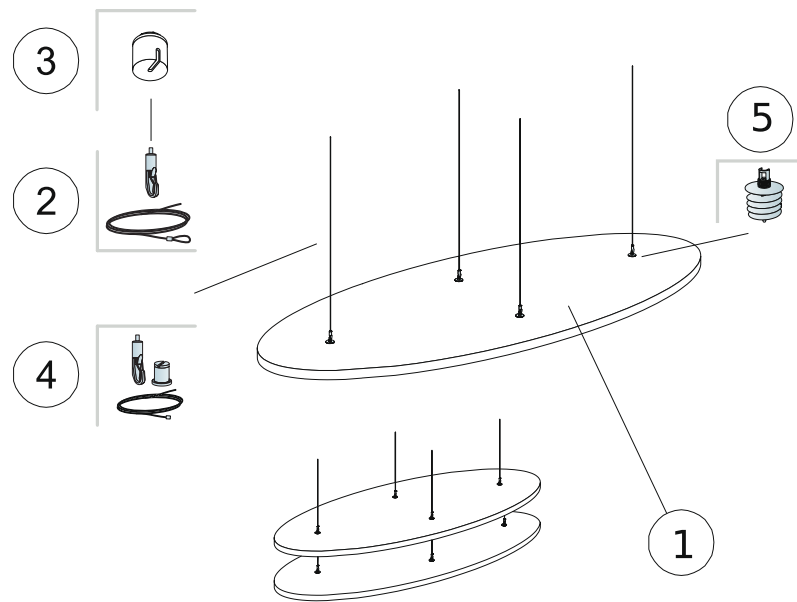

MÆNGDESPECIFIKATION (EKSKLUSIV SPILD)

	Størrelse, mm
	2400x1000
1 Solo Ellipse	1,89m ² /panel
2 Connect justerbar wire (Alt 1)	4/panel
3 Connect Dækkop (Alt.1, Valgfri)	4/panel
4 Connect justerbar wiresæt (Alt.1, Valgfri)	4/panel
5 Connect absorberent anker (Alt 1)	4/panel
Δ Min. total konstruktionshøjde: 140 mm	-
Ved montage af Connect absorberent-anker, anvend Connect absorberent-anker bits.	-

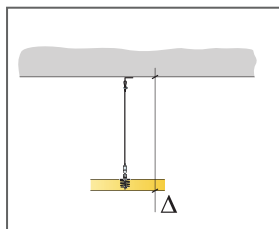

Se mængdespecifikation

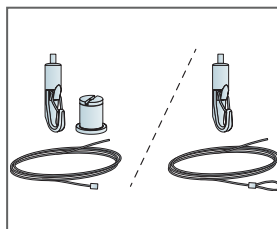

To typer af justerbar wire

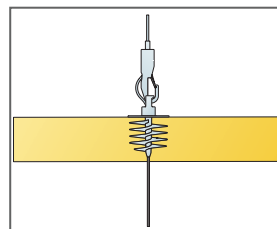

Paneler kan ophænges under hinanden

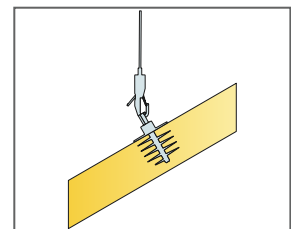

Paneler kan monteres i skrå vinkler.

Ecophon Solo™ Triangle

Solo Triangle er en frithængende enhed, der tilbyder designmuligheder på højt niveau. Tre forskellige ophængssystemer giver mulighed for at skabe flere lag og vinkler. Velegnet, når rumvolumen skal opretholdes, eller når det ikke er muligt at montere et heldækkende loft.



Chelamco Arena, Belgium

FORMATER



Størrelse, mm	1039x1200
Speciel montage	•
Tykkelse [Tk.]	40
Montageanvisning	M297

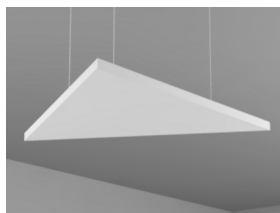

Frilhængende panel formet som en trekant



Nedhængning med Connect justerbar wire og Connect absorber-anker

Akustik



Værdierne i diagrammet henviser til en enkelt enhed. Hvis enhederne placeres i en klynge med afstande på mindre end 0,5 meter, bliver A_{eq} pr. enhed let reduceret.

Lydabsorption:

Testresultat baseret på EN ISO 354.

A_{eq} ækvivalent absorptionsareal pr. enhed (m^2 sabin)

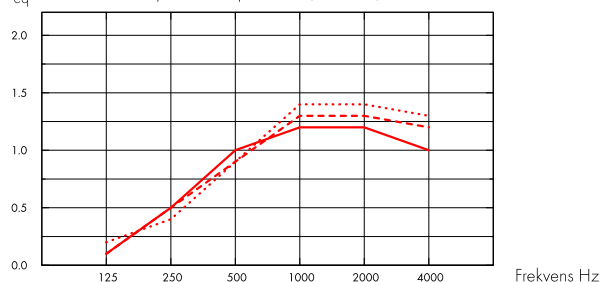

- Solo Triangle 1039x1200, 200 mm o.d.s.
 - - - Solo Triangle 1039x1200, 400 mm o.d.s.
 - · · Solo Triangle 1039x1200, 1000 mm o.d.s.
- o.d.s = tkh = total konstruktionshøjde

Tk. mm	tkh mm	A_{eq} ækvivalent absorptionsareal pr. enhed (m^2 sabin)					
		125 Hz	250 Hz	500 Hz	1000 Hz	2000 Hz	4000 Hz
40	200	0.1	0.5	1.0	1.2	1.2	1.0
40	400	0.1	0.5	0.9	1.3	1.3	1.2
40	1000	0.2	0.4	0.9	1.4	1.4	1.3



Indeklima

Certifikat / Label

Eurofins Indoor Air Comfort®

IAC Gold

Fransk VOC

A+



Cradle to Cradle Certified®



Dette produkt er Cradle to Cradle Certificeret® på bronze niveau (version 4.0).



Material Health



Dette produkt har modtaget et C2C Certified Material Health Certificate™ på sølv niveau (standardversion 4.0). C2C Certified Material Health Certificate™ er en verifikation af sundheden og sikkerheden af et produkts sammensætning ved hjælp af Material Health-kravene i Cradle-to-Cradle Certified Product Standard.



Miljøpåvirkning

kg CO₂ equiv/m²

Solo
Freedom

8,41 (Solo Family EPD i overensstemmelse med ISO 14025 / EN 15804)

Livscyklusstadier A1 til C4 fra EPD, i overensstemmelse med ISO 14025 / EN 15804



Circularity

Mindste indhold af genbrugsmateriale	57%
Genanvendelighed	Fuldt genanvendeligt



Brandsikkerhed

Land	Fire standard	Klasse
Europa	EN 13501-1	A2-s1,d0

Kernen af glasuld er testet og klassificeret som ikke-brændbar i henhold til EN ISO 1182.



Fugtbestandighed

Klasse C, relativ fugtighed 95% og 30° C, i henhold til EN 13964: 2014



Visuelt udseende

White Frost, nærmeste NCS-farveprøve S 0500-N, 85% lysreflektion. Glans < 1.



Rengøring

Tåler daglig støvsugning og aftørring, samt ugentlig våd aftørring med klud.



Tilgængelighed

Panelerne er demonterbare.



Montage

Monteres i henhold til montageanvisning, installationsguide og CAD-tegninger. Information vedrørende min. total konstruktionshøjde, se Mængdespecifikation.



System vægt

	kg/m ²
Solo Triangle	4,7

Vægt oplysninger er vejledende og kan variere.



Mekaniske egenskaber

Panelet tåler både punktbelastninger og fordelt belastning. Se Funktionskrav - mekaniske egenskaber på www.ecophon.dk



CE

Ecophon loftsystemer er CE-mærket i henhold til den europæiske harmoniserede standard EN 13964: 2014. CE-mærkede byggevarer er omfattet af en DOP (Declaration of Performance), som gør det muligt for kunder og brugere at sammenligne de tilgængelige produkter på det europæiske marked.

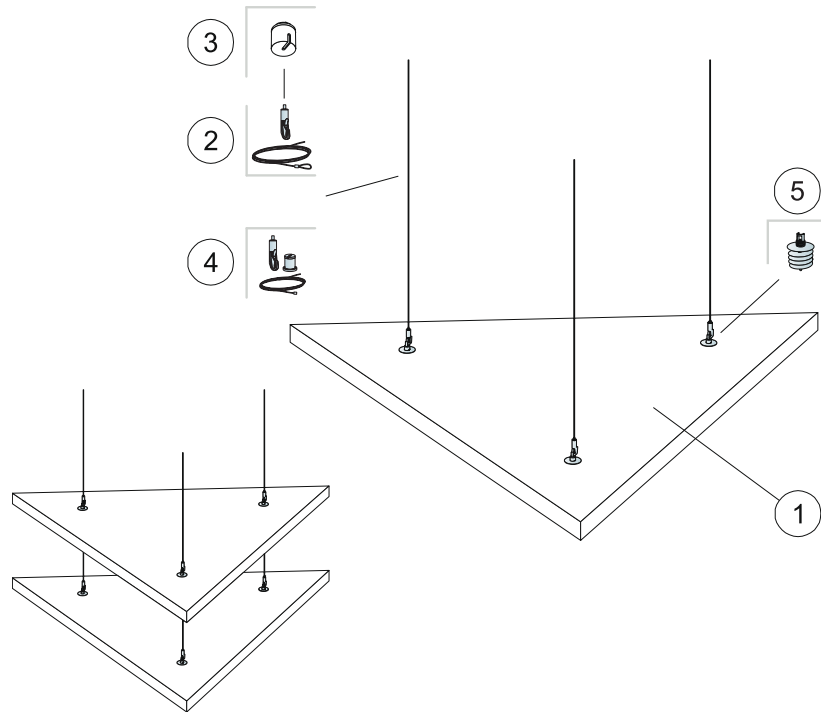

MÆNGDESPECIFIKATION (EKSKLUSIV SPILD)

		Størrelse, mm
		1039x1200
1	Solo Triangle	0,62m ² /panel
2	Connect justerbar wire	3/panel
3	Connect Dækkop (Alt.1, Valgfri)	3/panel
4	Connect justerbar wiresæt (Alt.1, Valgfri)	3/panel
5	Connect absorbt anker	3/panel
Δ Min. total konstruktionshøjde: 140 mm		-
Ved montage af Connect absorbt-anker, anvend Connect absorbt-anker bits.		-



Se mængdespecifikation

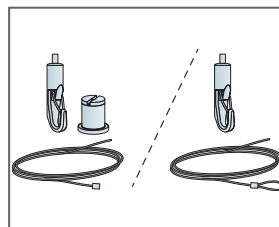

To typer af justerbar wire

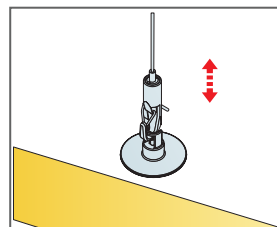

Let justerbar nedhængning med Connect justerbar wire

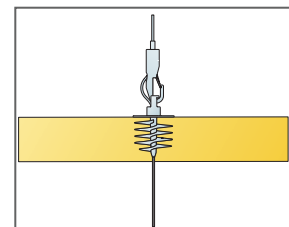

Paneler kan ophænges under hinanden

Ecophon Solo™ Pentagon

Solo Pentagon er en frithængende enhed, der tilbyder designmuligheder på højt niveau. Tre forskellige ophængssystemer giver mulighed for at skabe flere lag og vinkler. Velegnet, når rumvolumen skal opretholdes, eller når det ikke er muligt at montere et heldækkende loft.



Ghelamco Arena, Belgium

FORMATER



Størrelse, mm	1139x1198
Speciel montage	•
Tykkelse (Tk.)	40
Montageanvisning	M427

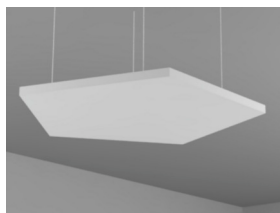

Solo Pentagon



Nedhængning med Connect justerbar wire og Connect absorber-anker

Akustik



Værdierne i diagrammet henviser til en enkelt enhed. Hvis enhederne placeres i en klynge med afstande på mindre end 0,5 meter, bliver Aeq pr. enhed let reduceret.

Lydabsorption:

Testresultat baseret på EN ISO 354.

A_{eq}: ækvivalent absorptionsareal pr. enhed (m² sabin)

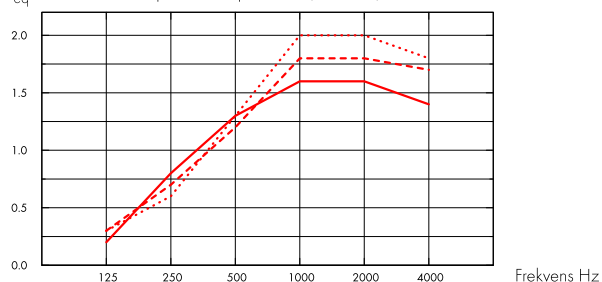

- Solo Pentagon 1139x1198, 200 mm o.d.s.
 - - - Solo Pentagon 1139x1198, 400 mm o.d.s.
 - · · Solo Pentagon 1139x1198, 1000 mm o.d.s.
- o.d.s = tkh = total konstruktionshøjde

Tk. mm	tkh mm	A _{eq} ækvivalent absorptionsareal pr. enhed (m ² sabin)					
		125 Hz	250 Hz	500 Hz	1000 Hz	2000 Hz	4000 Hz
40	200	0.2	0.8	1.3	1.6	1.6	1.4
40	400	0.3	0.7	1.2	1.8	1.8	1.7
40	1000	0.3	0.6	1.3	2.0	2.0	1.8



Indeklima

Certifikat / Label

Eurofins Indoor Air Comfort®

IAC Gold



Fransk VOC

A+



Cradle to Cradle Certified®



Dette produkt er Cradle to Cradle Certificeret® på bronze niveau (version 4.0).



Material Health



Dette produkt har modtaget et C2C Certified Material Health Certificate™ på sølv niveau (standardversion 4.0). C2C Certified Material Health Certificate™ er en verifikation af sundheden og sikkerheden af et produkts sammensætning ved hjælp af Material Health-kravene i Cradle-to-Cradle Certified Product Standard.



Miljøpåvirkning

	kg CO ₂ equiv/m ²
Solo Freedom	8,41 (Solo Family EPD i overensstemmelse med ISO 14025 / EN 15804)

Livscyklusstadier A1 til C4 fra EPD, i overensstemmelse med ISO 14025 / EN 15804



Circularity

Mindste indhold af genbrugsmateriale	57%
Genanvendelighed	Fuldt genanvendeligt



Brandsikkerhed

Land	Fire standard	Klasse
Europa	EN 13501-1	A2-s1,d0

Kernen af glasuld er testet og klassificeret som ikke-brændbar i henhold til EN ISO 1182.



Fugtbestandighed

Klasse C, relativ fugtighed 95% og 30° C, i henhold til EN 13964: 2014



Visuelt udseende

White Frost, nærmeste NCS-farveprøve S 0500-N, 85% lysreflektion. Glans < 1.



Rengøring

Tåler daglig støvsugning og aftørring, samt ugentlig vådaftørring med klud.



Tilgængelighed

Panelerne er demonterbare.



Montage

Monteres i henhold til montageanvisning, installationsguide og CAD-tegninger. Information vedrørende min. total konstruktionshøjde, se Mængdespecifikation.



System vægt

	kg/m ²
Solo Pentagon	4,7

Vægt oplysninger er vejledende og kan variere.



Mekaniske egenskaber

Panelet tåler både punktbelastninger og fordelt belastning. Se Funktionskrav - mekaniske egenskaber på www.ecophon.dk



CE

Ecophon loftsystemer er CE-mærket i henhold til den europæiske harmoniserede standard EN 13964: 2014. CE-mærkede byggevarer er omfattet af en DOP (Declaration of Performance), som gør det muligt for kunder og brugere at sammenligne de tilgængelige produkter på det europæiske marked.

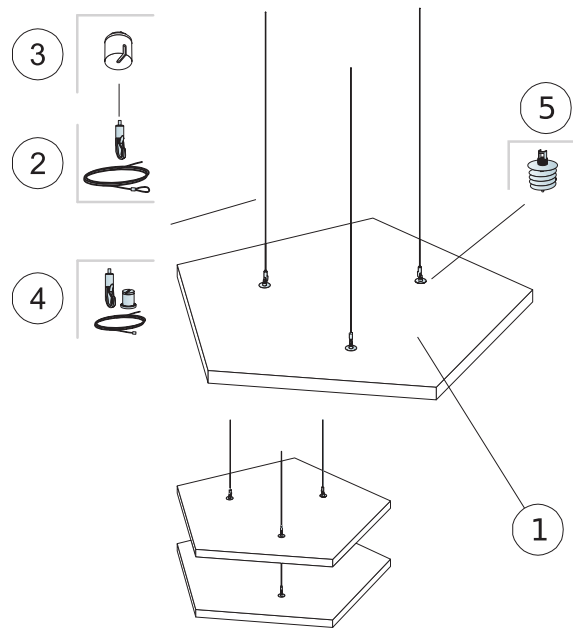

MÆNGDESPECIFIKATION (EKSKLUSIV SPILD)

		Størrelse, mm
		1139x1198
1	Solo Pentagon	0,94m ² /panel
2	Connect justerbar wire (Alt 1)	3/panel
3	Connect Dækkop (Alt.1, Valgfri)	3/panel
4	Connect justerbar wiresæt (Alt.1, Valgfri)	3/panel
5	Connect absorbtent anker (Alt 1)	3/panel
Δ Min. total konstruktionshøjde: 140 mm		-
Ved montage af Connect absorbtent-anker, anvend Connect absorbtent-anker bits.		-



Se mængdespecifikation



To typer af justerbar wire



Paneler kan ophænges under hinanden

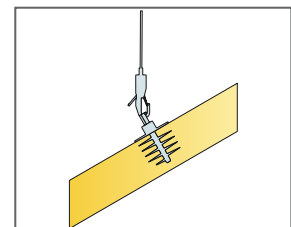

Paneler kan monteres i skrå vinkler.

Ecophon Solo™ Hexagon

Solo Hexagon er en frithængende enhed, der tilbyder designmuligheder på højt niveau. Tre forskellige ophængssystemer giver mulighed for at skabe flere lag og vinkler. Velegnet, når rumvolumen skal opretholdes, eller når det ikke er muligt at montere et heldækkende loft.



Chelance Arena, Belgium

FORMATER



Størrelse, mm	1040x1200
Speciel montage	•
Tykkelse (Tk.)	40
Montageanvisning	M426

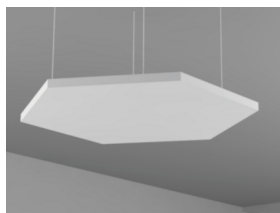

Fritstående panel formet som en hexagon



Nedhængning med Connect justerbar wire og Connect absorberanker

Akustik



Værdierne i diagrammet henviser til en enkelt enhed. Hvis enhederne placeres i en klynge med afstande på mindre end 0,5 meter, bliver A_{eq} pr. enhed let reduceret.

Lydabsorption:

Testresultat baseret på EN ISO 354.

A_{eq} ækvivalent absorptionsareal pr. enhed (m^2 sabin)

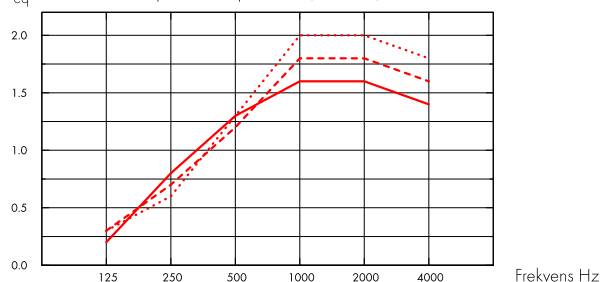

- Solo Hexagon 1040x1200, 200 mm o.d.s.
 - - - Solo Hexagon 1040x1200, 400 mm o.d.s.
 - · · Solo Hexagon 1040x1200, 1000 mm o.d.s.
- o.d.s = tkh = total konstruktionshøjde

Tk. mm	tkh mm	A_{eq} ækvivalent absorptionsareal pr. enhed (m^2 sabin)					
		125 Hz	250 Hz	500 Hz	1000 Hz	2000 Hz	4000 Hz
40	200	0.2	0.8	1.3	1.6	1.6	1.4
40	400	0.3	0.7	1.2	1.8	1.8	1.6
40	1000	0.3	0.6	1.3	2.0	2.0	1.8

Indeklima



Certifikat / Label

Eurofins Indoor Air Comfort®

IAC Gold



Fransk VOC

A+



Cradle to Cradle Certified®



Dette produkt er Cradle to Cradle Certificeret® på bronze niveau (version 4.0).



Material Health



Dette produkt har modtaget et C2C Certified Material Health Certificate™ på sølv niveau (standardversion 4.0). C2C Certified Material Health Certificate™ er en verifikation af sundheden og sikkerheden af et produkts sammensætning ved hjælp af Material Health-kravene i Cradle-to-Cradle Certified Product Standard.



Miljøpåvirkning

kg CO₂ equiv/m²

Solo
Freedom

8,41 (Solo Family EPD i overensstemmelse med ISO 14025 / EN 15804)

Livscyklusstadier A1 til C4 fra EPD, i overensstemmelse med ISO 14025 / EN 15804



Circularity

Mindste indhold af genbrugsmateriale	57%
Genanvendelighed	Fuldt genanvendeligt



Brandsikkerhed

Land	Fire standard	Klasse
Europa	EN 13501-1	A2-s1,d0

Kernen af glasuld er testet og klassificeret som ikke-brændbar i henhold til EN ISO 1182.



Fugtbestandighed

Klasse C, relativ fugtighed 95% og 30° C, i henhold til EN 13964: 2014



Visuelt udseende

White Frost, nærmeste NCS-farveprøve S 0500-N, 85% lysreflektion. Glans < 1.



Rengøring

Tåler daglig støvsugning og aftørring, samt ugentlig vådaftørring med klud.



Tilgængelighed

Panelerne er demonterbare.



Montage

Monteres i henhold til montageanvisning, installationsguide og CAD-tegninger. Information vedrørende min. total konstruktionshøjde, se Mængdespecifikation.



System vægt

	kg/m ²
Solo Hexagon	4,7

Vægt oplysninger er vejledende og kan variere.



Mekaniske egenskaber

Panelet tåler både punktbelastninger og fordelt belastning. Se Funktionskrav - mekaniske egenskaber på www.ecophon.dk



CE

Ecophon loftsystemer er CE-mærket i henhold til den europæiske harmoniserede standard EN 13964: 2014. CE-mærkede byggevarer er omfattet af en DOP (Declaration of Performance), som gør det muligt for kunder og brugere at sammenligne de tilgængelige produkter på det europæiske marked.

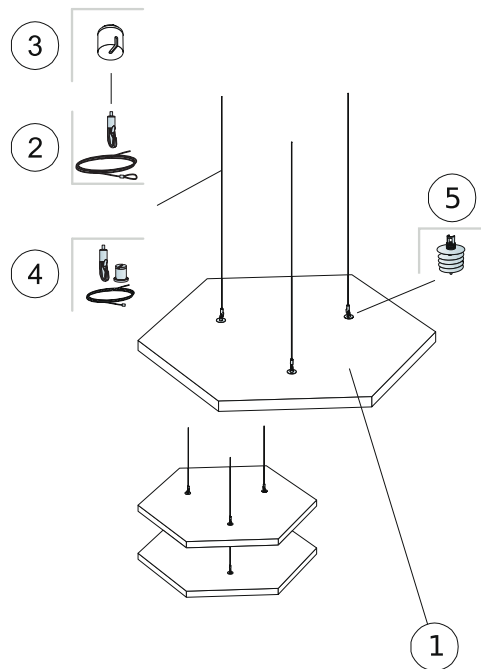

MÆNGDESPECIFIKATION (EKSKLUSIV SPILD)

		Størrelse, mm
		1040x1200
1	Solo Hexagon	0,94m ² /panel
2	Connect justerbar wire (Alt 1)	3/panel
3	Connect Dækkop (Alt.1, Valgfri)	3/panel
4	Connect justerbar wiresæt (Alt.1, Valgfri)	3/panel
5	Connect absorbt anker (Alt 1)	3/panel
Δ Min. total konstruktionshøjde: 140 mm		-
Ved montage af Connect absorbt-anker, anvend Connect absorbt-anker bits.		-



Se mængdespecifikation



To typer af justerbar wire

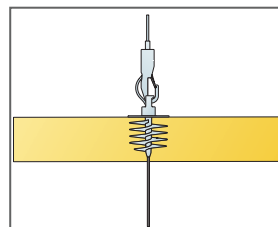

Paneler kan ophænges under hinanden

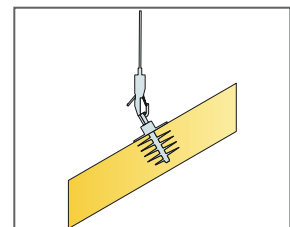

Paneler kan monteres i skrå vinkler.

Ecophon Solo™ Baffle

Ecophon Solo™ Baffle er lodret monterede og urammede bafle. Solo Baffle kan bruges til at danne skarpe linjer og fås i forskellige størrelser og en lang række farver. Bafle bruges primært, hvor det naturlige lys kommer ind i rummet via ovenlysvinduer.

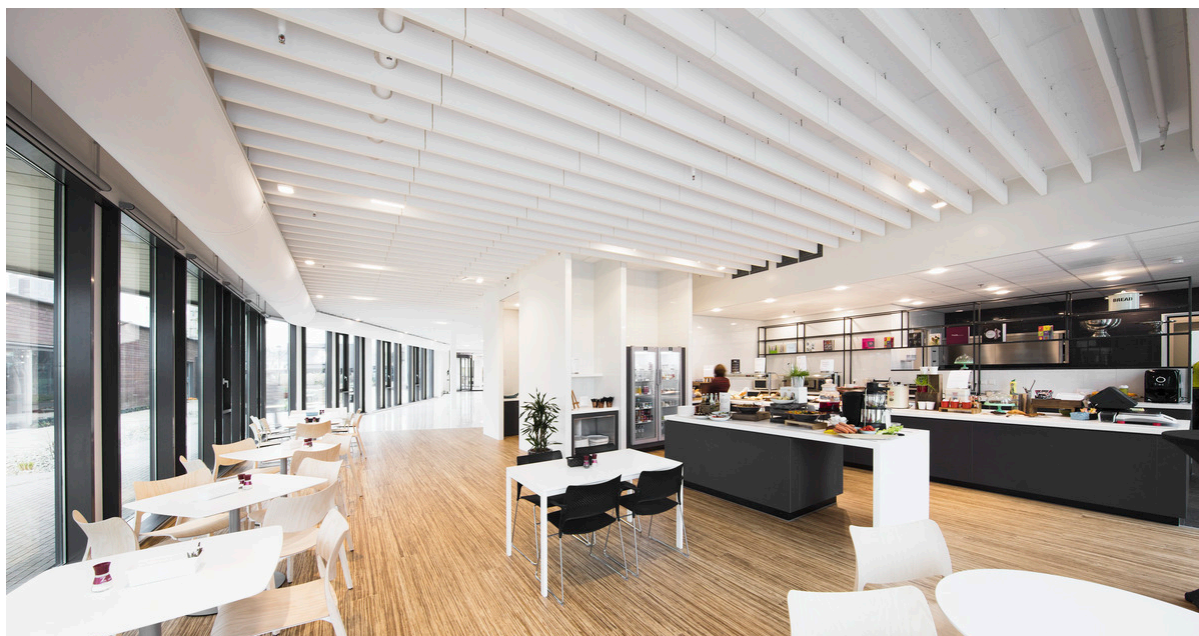

Plantionics, Hoofddorp, Netherlands

FORMATER

Størrelse, mm	1200x200	1200x300	1200x600	1800x200	1800x300	1800x600
Speciel montage	•	•	•	•	•	•
Tykkelse (Tk.)	40	40	40	40	40	40
Montageanvisning	M414, M491, M563, M580	M414, M491, M563, M580	M414, M491, M563, M580	M414, M491, M563, M580	M414, M491, M563, M580	M414, M491, M563, M580

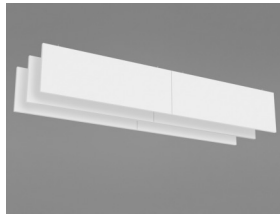

Solo Baffle



Solo Baffle/anker



Solo Baffle/anker montage

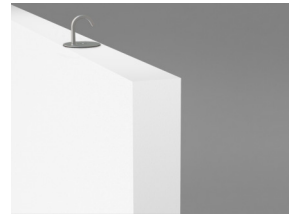

Solo Baffle/krog

Akustik



Lydabsorption:

Testresultat i henhold til EN ISO 354:2003 NOTE: Viste resultatater kan ikke sammenlignes med resultater af ældre versioner af denne standard grundet uoverensstemmelser i testmetode. Klassificering i henhold til EN ISO 11654, og værdier for Noise Reduction Coefficient, NRC og Sound Absorption Average, SAA i henhold til ASTM C 423.

α_p , Praktisk absorptionsfaktor

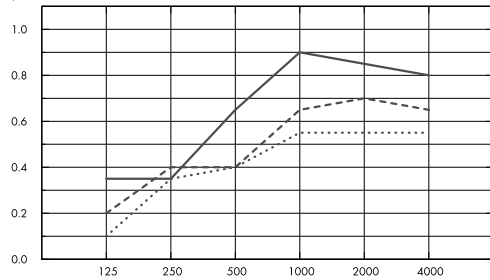

Frekvens Hz

--- Solo Baffle 1200/1800x200, afstand 600mm, direkte monteret

--- Solo Baffle 1200/1800x300, afstand 600mm, direkte monteret

— Solo Baffle 1200/1800x600, afstand 600mm, direkte monteret

o.d.s = tkh = total konstruktionshøjde

A_{eq} ækvivalent absorptionsareal pr. enhed (m² sabin)

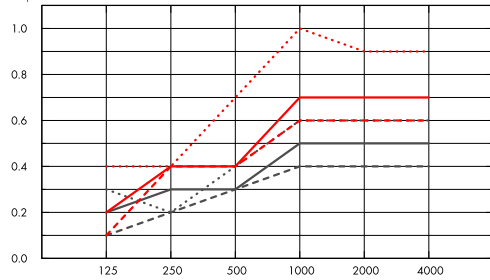

Frekvens Hz

--- Solo Baffle 1200x200

— Solo Baffle 1200x300

--- Solo Baffle 1200x600

--- Solo Baffle 1800x200

— Solo Baffle 1800x300

--- Solo Baffle 1800x600

o.d.s = tkh = total konstruktionshøjde

	Tk. mm	tkh mm	α_p , Praktisk absorptionsfaktor						α_w
			125 Hz	250 Hz	500 Hz	1000 Hz	2000 Hz	4000 Hz	
c600	40	200	0.10	0.35	0.40	0.55	0.55	0.55	0.50
c600	40	300	0.20	0.40	0.40	0.65	0.70	0.65	0.50
c600	40	600	0.35	0.35	0.65	0.90	0.85	0.80	0.65

	Tk. mm	tkh mm	A_{eq} ækvivalent absorptionsareal pr. enhed (m ² sabin)					
			125 Hz	250 Hz	500 Hz	1000 Hz	2000 Hz	4000 Hz
1200x200 c600	40	200	0.1	0.2	0.3	0.4	0.4	0.4
1200x300 c600	40	300	0.2	0.3	0.3	0.5	0.5	0.5
1200x600 c600	40	600	0.3	0.2	0.4	0.6	0.6	0.6
1800x200 c600	40	200	0.1	0.4	0.4	0.6	0.6	0.6
1800x300 c600	40	300	0.2	0.4	0.4	0.7	0.7	0.7
1800x600 c600	40	600	0.4	0.4	0.7	1.0	0.9	0.9

	Tk. mm	ikh mm	NRC	SAA
c200	40	200	0.65	0.65
c400	40	200	0.50	0.51
c600	40	200	0.45	0.43
c800	40	200	0.40	0.37
c200	40	300	0.70	0.71
c400	40	300	0.60	0.61
c600	40	300	0.55	0.53
c800	40	300	0.45	0.46
c200	40	600	0.80	0.82
c400	40	600	0.75	0.74
c600	40	600	0.70	0.67
c800	40	600	0.60	0.60



Indeklima

Certifikat / Label

Eurofins Indoor Air Comfort®

IAC Gold

Fransk VOC

A+



Cradle to Cradle Certified®



Dette produkt er Cradle to Cradle Certificeret® på bronze niveau (version 4.0).



Material Health



Dette produkt har modtaget et C2C Certified Material Health Certificate™ på sølv niveau (standardversion 4.0). C2C Certified Material Health Certificate™ er en verifikation af sundheden og sikkerheden af et produkts sammensætning ved hjælp af Material Health-kravene i Cradle-to-Cradle Certified Product Standard.



Miljøpåvirkning

	kg CO ₂ equiv/m ²
Solo Baffle & Solo Baffle Wall	10,11

Livscyklusstadier A1 til C4 fra EPD, i overensstemmelse med ISO 14025 / EN 15804



Circularity

Mindste indhold af genbrugsmateriale	57%
Genanvendelighed	Fuldt genanvendeligt



Brandsikkerhed

Land	Fire standard	Klasse
Europa	EN 13501-1	A2-s1,d0

Kernen af glasuld er testet og klassificeret som ikke-brændbar i henhold til EN ISO 1182.



Fugtbestandighed

Klasse C, relativ fugtighed 95% og 30° C, i henhold til EN 13964: 2014



Visuelt udseende

White Frost, nærmeste NCS-farveprøve S 0500-N, 85% lysreflektion. Glans < 1.



Rengøring

Tåler daglig støvsugning og aftørring, samt ugentlig vådftørring med klud.



Tilgængelighed

Panelerne er demonterbare.



Montage

Monteres i henhold til montageanvisning, installationsguide og CAD-tegninger. Information vedrørende min. total konstruktionshøjde, se Mængdespecifikation.



System vægt

	kg/m ²	Vægt oplysninger er vejledende og kan variere.
Solo Baffle	4,6	



Mekaniske egenskaber

Nyttelast skal fastgøres til loftet / underlaget.



CE

Ecophon loftsystemer er CE-mærket i henhold til den europæiske harmoniserede standard EN 13964: 2014. CE-mærkede byggevarer er omfattet af en DOP (Declaration of Performance), som gør det muligt for kunder og brugere at sammenligne de tilgængelige produkter på det europæiske marked.

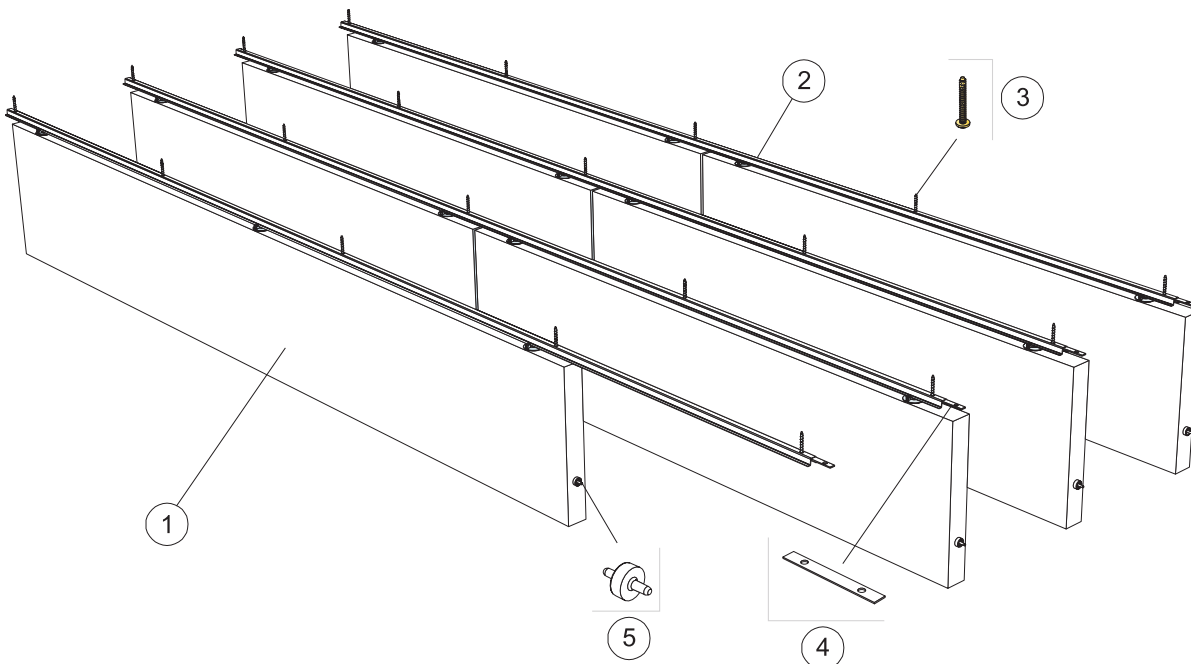

© Saint-Gobain Ecophon AB

MÆNGDESPECIFIKATION (EKSKLUSIV SPILD)

	Størrelse, mm					
	1200x200	1200x300	1200x600	1800x200	1800x300	1800x600
1 Solo Baffle/anker, monteret c300 mm.	2,8/m ²	2,8/m ²	2,8/m ²	1,9/m ²	1,9/m ²	1,9/m ²
2 Connect Baffle profil, monteres c 300 mm	3,3m/m ²	3,3m/m ²	3,3m/m ²	3,3m/m ²	3,3m/m ²	3,3m/m ²
3 Connect ankerskrue, monteres c 1200 mm	2,8/m ²	2,8/m ²	2,8/m ²	2,8/m ²	2,8/m ²	2,8/m ²
4 Connect samlelaske, monteres c 2400 mm	1,4/m ²	1,4/m ²	1,4/m ²	1,4/m ²	1,4/m ²	1,4/m ²
5 Connect styrestift, monteret c 1200/1800 mm.	2,8/m ²	2,8/m ²	2,8/m ²	1,9/m ²	1,9/m ²	1,9/m ²

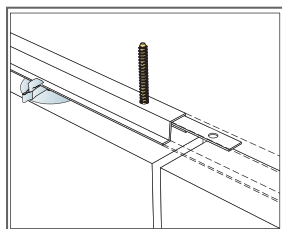

Montage af Connect profil samlelaske

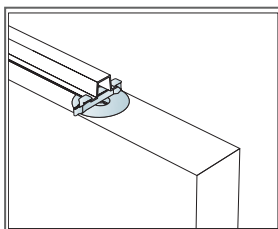

Baflerne er sikrede med clips

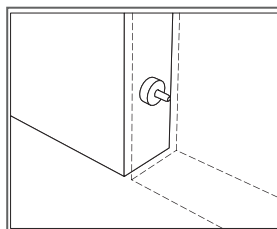

Connect styrestift anvendes til at holde afstand mellem panelerne

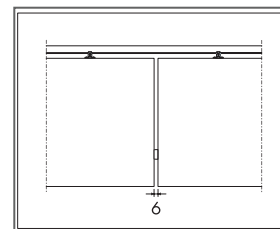

Tydeligt mellemrum på 6 mm mellem hver baffel med Connect styrestift

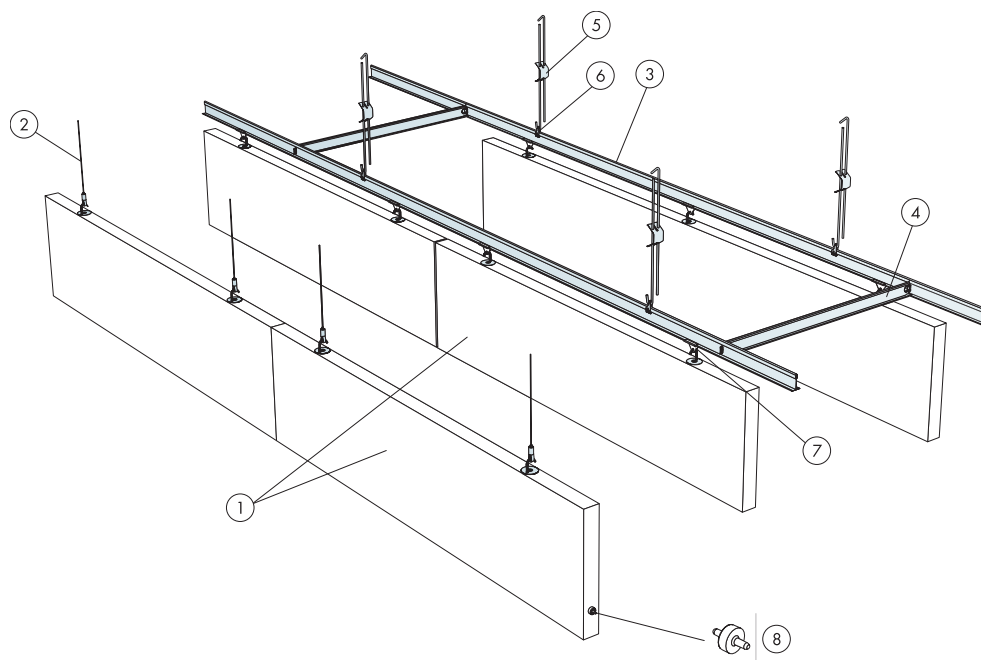

© Saint-Gobain Ecophon AB

MÆNGDESPECIFIKATION (EKSKLUSIV SPILD)

	Størrelse, mm					
	1200x200	1200x300	1200x600	1800x200	1800x300	1800x600
1 Solo Baffle/krog, monteret c600 mm.	1,4/m ²	1,4/m ²	1,4/m ²	0,9/m ²	0,9/m ²	0,9/m ²
2 Connect justerbar wire (Alt 1)	2/panel	2/panel	2/panel	3/panel	3/panel	3/panel
3 Connect T24 hovedprofil, monteres c 600 mm (Alt. 2)	1,7m/m ²	1,7m/m ²	1,7m/m ²	1,7m/m ²	1,7m/m ²	1,7m/m ²
4 Connect T24 tværprofil, L=600 mm, monteres c 1800 mm (Alt. 2)	0,6m/m ²	0,6m/m ²	0,6m/m ²	0,6m/m ²	0,6m/m ²	0,6m/m ²
5 Connect justerbar strop (Alt 2) c1200 mm	1,4/m ²	1,4/m ²	1,4/m ²	1,4/m ²	1,4/m ²	1,4/m ²
6 Connect Stropfæste (Alt. 2)	1,4/m ²	1,4/m ²	1,4/m ²	1,4/m ²	1,4/m ²	1,4/m ²
7 Connect Baffle clips (Alt. 2)	2,8/m ²	2,8/m ²	2,8/m ²	2,8/m ²	2,8/m ²	2,8/m ²
8 Connect styrestift, monteret c 1200/1800 mm	2,8/m ²	2,8/m ²	2,8/m ²	0,9/m ²	0,9/m ²	0,9/m ²

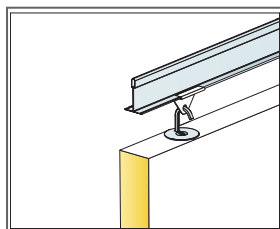

Nedhængningsdetalje

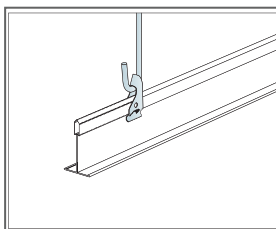

Nedhængning med justerbar strop og stropfæste

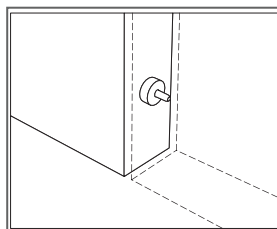

Connect styrestift anvendes til at holde afstand mellem panelerne

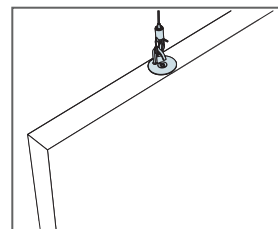

Nedhængning med Connect justerbar wire

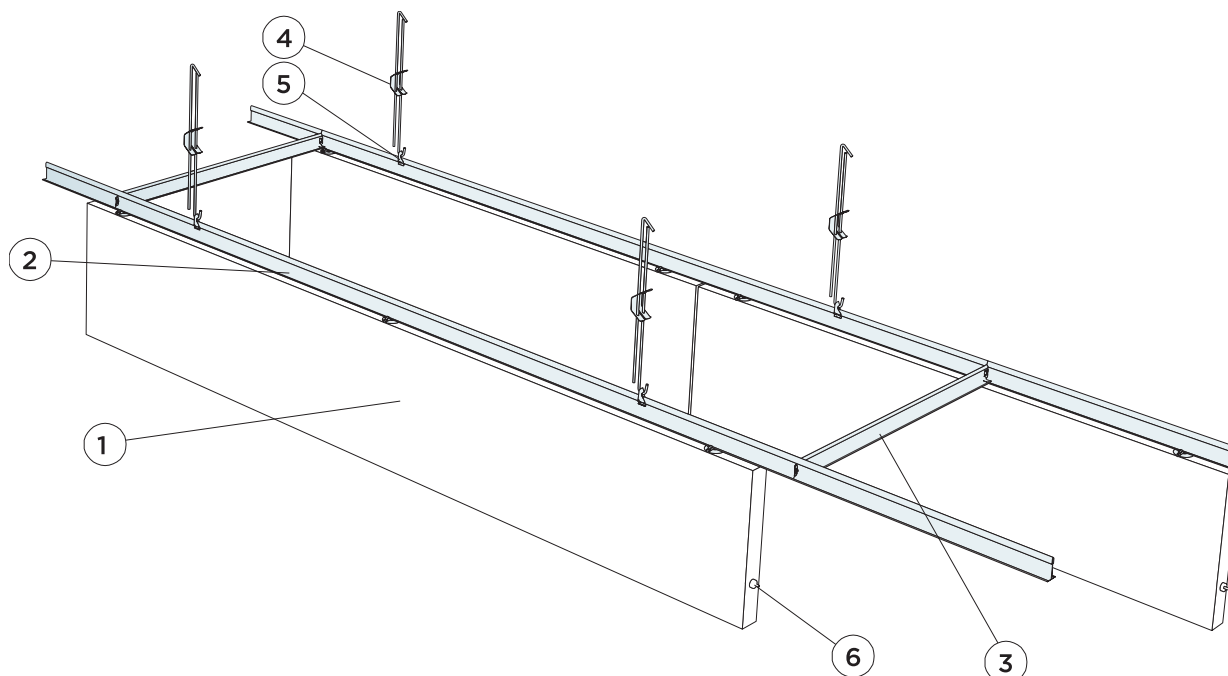

© Saint-Gobain Ecophon AB

MÆNGDESPECIFIKATION (EKSKLUSIV SPILD)

	Størrelse, mm					
	1200x200	1200x300	1200x600	1800x200	1800x300	1800x600
1 Solo Baffle/anker, monteret c600 mm.	1,4/m ²	1,4/m ²	1,4/m ²	0,9/m ²	0,9/m ²	0,9/m ²
2 Connect T24 hovedprofil, monteres c 600 mm (Alt. 2)	1,7m/m ²	1,7m/m ²	1,7m/m ²	1,7m/m ²	1,7m/m ²	1,7m/m ²
3 Connect T24 tværprofil, L=600 mm, monteres c 1800 mm (Alt. 2)	0,6m/m ²	0,6m/m ²	0,6m/m ²	0,6m/m ²	0,6m/m ²	0,6m/m ²
4 Connect justerbar strop (Alt 2) c1200 mm	1,4/m ²	1,4/m ²	1,4/m ²	1,4/m ²	1,4/m ²	1,4/m ²
5	-	-	0,7/m ²	-	-	-
6 Connect styrestift, monteret c 1200/1800 mm	2,8/m ²	2,8/m ²	2,8/m ²	0,9/m ²	0,9/m ²	0,9/m ²

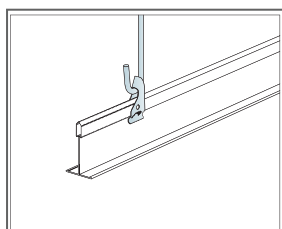

Nedhængning med justerbar strop og stropfæste

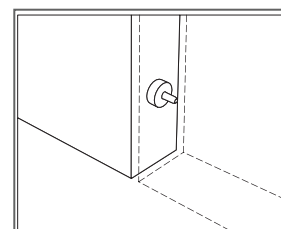

Connect styrestift anvendes til at holde afstand mellem panelerne

INSTALLATION DIAGRAM (M563) FOR ECOPHON SOLO BAFFLE/HOOK

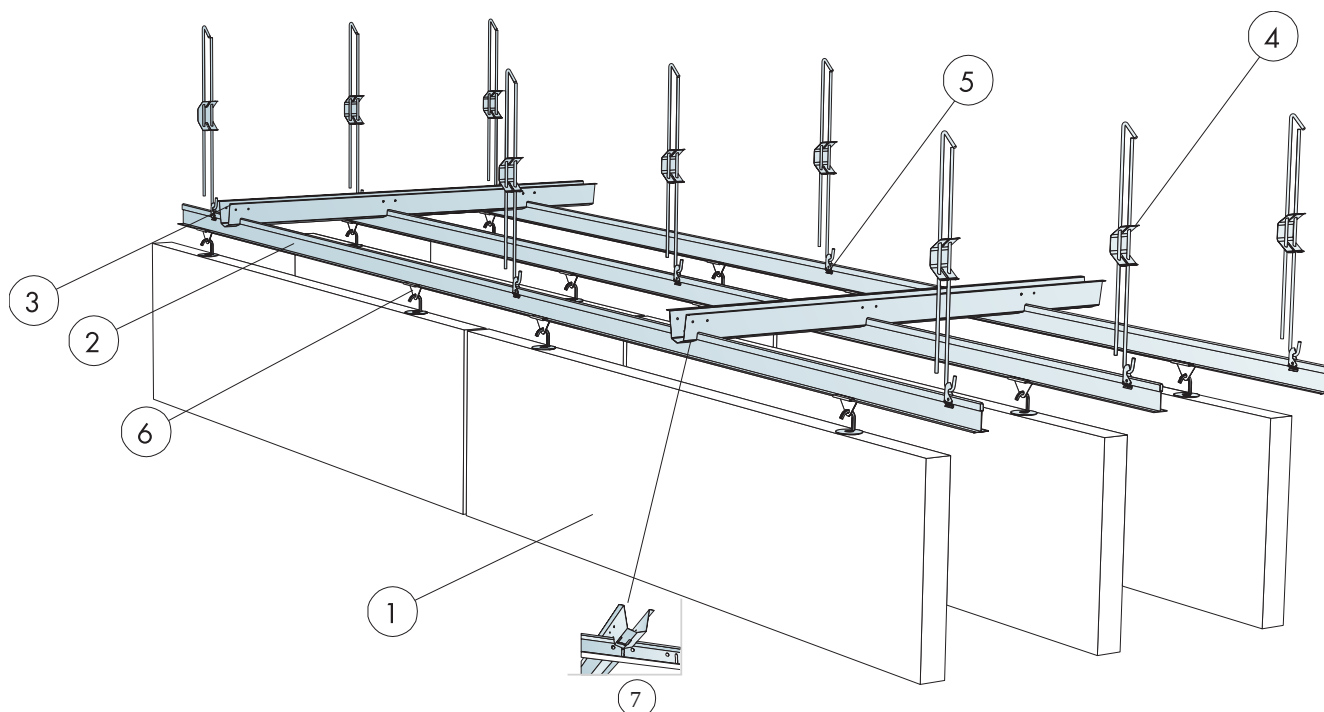

MÆNGDESPECIFIKATION (EKSKLUSIV SPILD)

	Størrelse, mm					
	1200x200	1200x300	1200x600	1800x200	1800x300	1800x600
1 Solo Baffle/krog, monteret c600 mm.	1,4/m ²	1,4/m ²	1,4/m ²	1,9/m ²	1,9/m ²	1,9/m ²
2 Connect T24 hovedprofil HD, monteres c 600 mm	-	-	-	-	-	1,7m/m ²
3 Connect distanceprofil	-	-	efter opmåling	-	-	efter opmåling
4 Connect justerbar strop (Alt 2) c1200 mm	1,4/m ²	1,4/m ²	1,4/m ²	1,4/m ²	1,4/m ²	1,4/m ²
5	-	-	0,7/m ²	-	-	-
6 Connect Baffle clips (Alt. 2)	2,8/m ²	2,8/m ²	2,8/m ²	2,8/m ²	2,8/m ²	2,8/m ²
7	-	-	1,1/m ²	-	-	1,1/m ²
	-	-	-	-	-	-

Ecophon Solo™ Baffle Wave

Ecophon Solo™ Baffle Wave er lodret monterede og urammede baffler. Den bølgeformede baffel giver rummet et særligt designpræg samt muligheden for at udtrykke designet gennem form og farve. Baffler bruges primært, hvor det naturlige lys kommer ind i rummet via ovenlysvinduer.



Kurikka Campus Kurikka, Finland

FORMATER



Størrelse, mm	1800x300	1800x600
Speciel montage	•	•
Tykkelse (Tk.)	40	40
Montageanvisning	M495, M419	M495, M419

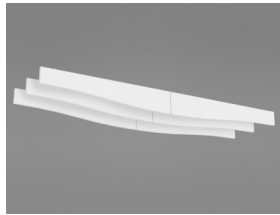

Solo Baffle Wave



Solo Baffle Wave/anker



Solo Baffle Wave/anker montage

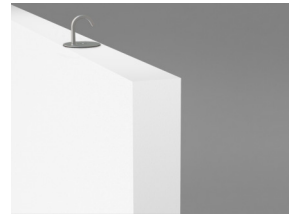

Solo Baffle Wave/krog

Akustik



Lydabsorption:

Testresultat i henhold til EN ISO 354:2003 NOTE: Viste resultatater kan ikke sammenlignes med resultater af ældre versioner af denne standard grundet uoverensstemmelser i testmetode. Klassificering i henhold til EN ISO 11654, og værdier for Noise Reduction Coefficient, NRC og Sound Absorption Average, SAA i henhold til ASTM C 423.

α_p , Praktisk absorptionsfaktor

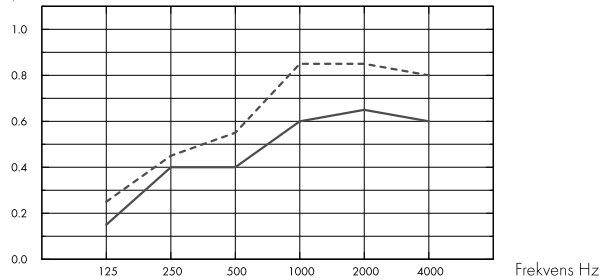

- Solo Baffle Wave 1800x300/200, afstand 600 mm, direkte monteret
- Solo Baffle Wave 1800x600/300, afstand 600 mm, direkte monteret
- o.d.s = tkh = total konstruktionshøjde

A_{eq} , ækvivalent absorptionsareal pr. enhed (m² sabin)

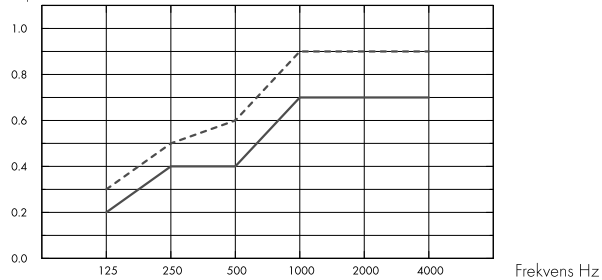

- Solo Baffle Wave 1800x300/200
- Solo Baffle Wave 1800x600/300
- o.d.s = tkh = total konstruktionshøjde

	Tk. mm	tkh mm	α_p , Praktisk absorptionsfaktor						α_w
			125 Hz	250 Hz	500 Hz	1000 Hz	2000 Hz	4000 Hz	
c600	40	300	0.15	0.40	0.40	0.60	0.65	0.60	0.50
c600	40	600	0.25	0.45	0.55	0.85	0.85	0.80	0.65

	Tk. mm	tkh mm	A_{eq} , ækvivalent absorptionsareal pr. enhed (m ² sabin)					
			125 Hz	250 Hz	500 Hz	1000 Hz	2000 Hz	4000 Hz
c600	40	300	0.2	0.4	0.4	0.7	0.7	0.7
c600	40	600	0.3	0.5	0.6	0.9	0.9	0.9

	Tk. mm	tkh mm	NRC	SAA
c600	40	300	0.50	0.52
c600	40	600	0.70	0.68



Indeklima

Certifikat / Label

Eurofins Indoor Air Comfort®	IAC Gold
Fransk VOC	A+



Cradle to Cradle Certified®



Dette produkt er Cradle to Cradle Certificeret® på bronze niveau (version 4.0).



Material Health



Dette produkt har modtaget et C2C Certified Material Health Certificate™ på sølv niveau (standardversion 4.0). C2C Certified Material Health Certificate™ er en verifikation af sundheden og sikkerheden af et produkts sammensætning ved hjælp af Material Health-kravene i Cradle-to-Cradle Certified Product Standard.



Miljøpåvirkning

	kg CO ₂ equiv/m ²	Livscyklusstadier A1 til C4 fra EPD, i overensstemmelse med ISO 14025 / EN 15804
Solo Baffle Wave	11,07	



Circularity

Mindste indhold af genbrugsmateriale	57%
Genanvendelighed	Fuldt genanvendeligt



Brandsikkerhed

Land	Fire standard	Klasse	Kernen af glasuld er testet og klassificeret som ikke-brændbar i henhold til EN ISO 1182.
Europa	EN 13501-1	A2-s1,d0	



Fugtbestandighed

Klasse C, relativ fugtighed 95% og 30° C, i henhold til EN 13964: 2014



Visuelt udseende

White Frost, nærmeste NCS-farveprøve S 0500-N, 85% lysreflektion. Glans < 1.



Rengøring

Tåler daglig støvsugning og aftørring, samt ugentlig vådaftørring med klud.



Tilgængelighed

Panelerne er demonterbare.



Montage

Monteres i henhold til montageanvisning, installationsguide og CAD-tegninger. Information vedrørende min. total konstruktionshøjde, se Mængdespecifikation.



System vægt

	kg/m ²	Vægt oplysninger er vejledende og kan variere.
Solo Baffle	4,6	



Mekaniske egenskaber

Nyttelast skal fastgøres til loftet / underlaget.



CE

Ecophon loftsystemer er CE-mærket i henhold til den europæiske harmoniserede standard EN 13964: 2014. CE-mærkede byggevarer er omfattet af en DOP (Declaration of Performance), som gør det muligt for kunder og brugere at sammenligne de tilgængelige produkter på det europæiske marked.

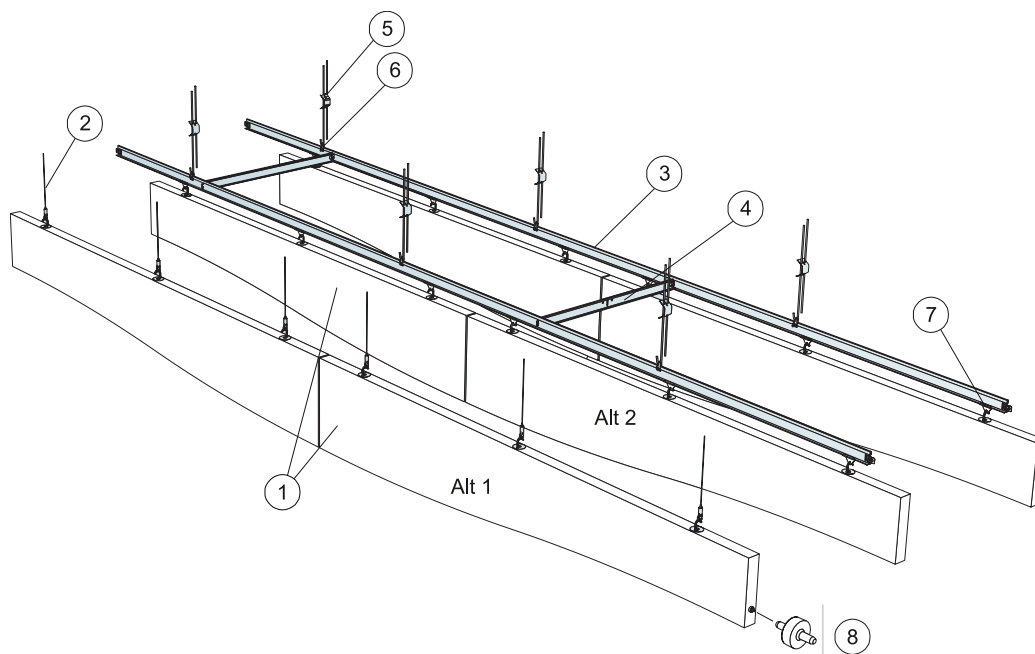

© Saint-Gobain Ecophon AB

MÆNGDESPECIFIKATION (EKSKLUSIV SPILD)

	Størrelse, mm	
	1800x300	1800x600
1 Solo Baffle Wave/krog, monteret c 600 mm.	0,9/m ²	0,9/m ²
2 Connect justerbar wire (Alt 1)	3/panel	3/panel
3 Connect T24 hovedprofil, monteres c 600 mm (Alt. 2)	1,7m/m ²	1,7m/m ²
4 Connect T24 tværprofil, L=600 mm, monteres c 1800 mm (Alt. 2)	0,6m/m ²	0,6m/m ²
5 Connect justerbar strop (Alt 2) c 1200 mm	1,4/m ²	1,4/m ²
6 Connect Stropfæste (Alt. 2)	1,4/m ²	1,4/m ²
7 Connect Baffle clips (Alt. 2)	2,8/m ²	2,8/m ²
8 Connect styrestift, monteret c 1800 mm.	0,9/m ²	0,9/m ²

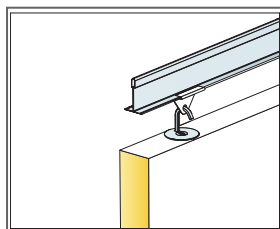

Udsnit af nedhængning

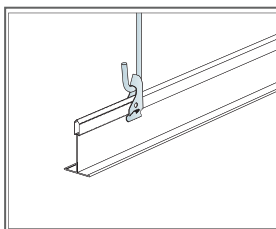

Nedhængning med justerbar strop og stropfæste

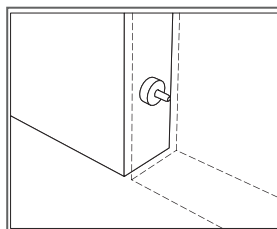

Connect styrestift anvendes til at holde afstand mellem panelerne

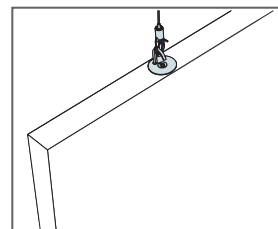

Nedhængning med Connect justerbar wire

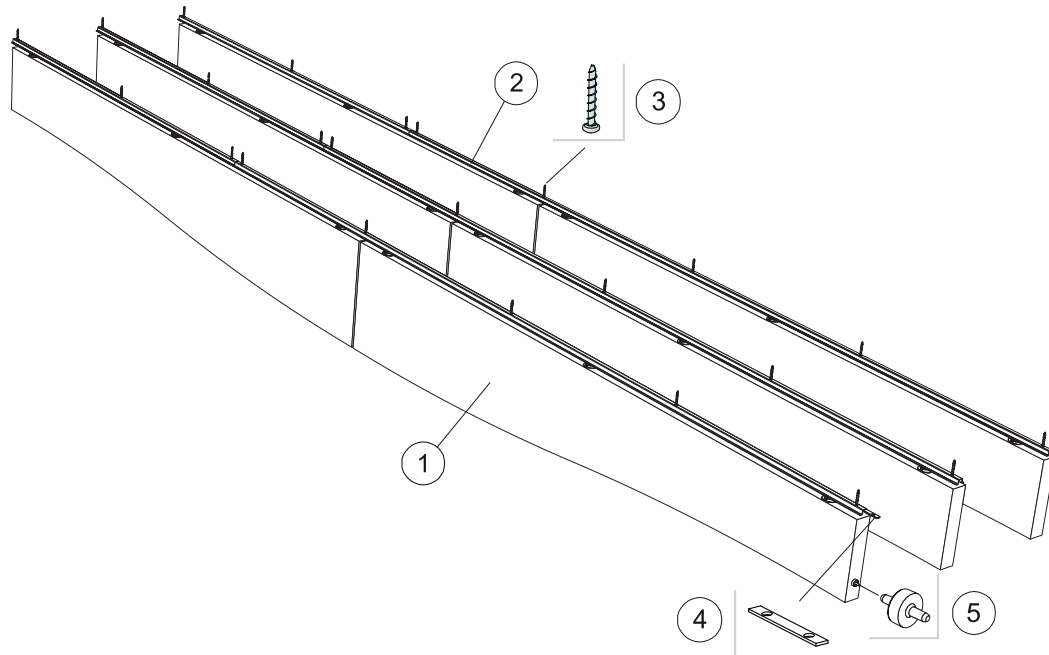

© Saint-Gobain Ecophon AB

MÆNGDESPECIFIKATION (EKSKLUSIV SPILD)

		Størrelse, mm	
		1800x300	1800x600
1	Solo Baffle Wave/anker, monteret c. 300 mm.	1,9/m ²	1,9/m ²
2	Connect Baffle profil, monteres c. 300 mm	3,3m/m ²	3,3m/m ²
3	Connect ankerskrue, monteres c. 1200 mm	2,8/m ²	2,8/m ²
4	Connect samlelaske, monteres c. 2400 mm	1,4/m ²	1,4/m ²
5	Connect styrestift, monteres c. 1800 mm	1,9/m ²	1,9/m ²

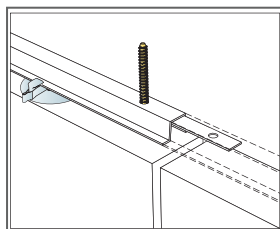

Montage af Connect profil samlelaske

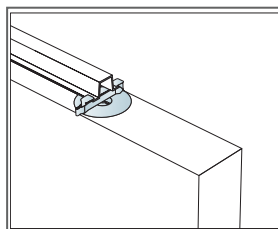

Baflerne er sikrede med clips

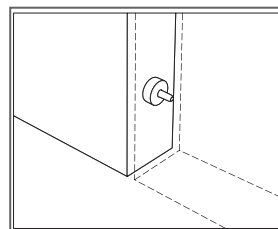

Connect styrestift anvendes til at holde afstand mellem panelerne

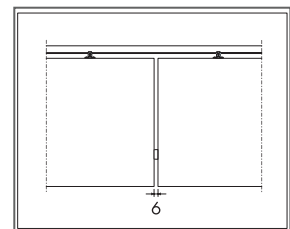

Tydeligt mellemrum på 6 mm mellem baffel med Connect styrestift

Ecophon Solo™ Baffle ZigZag

Ecophon Solo™ Baffle ZigZag er lodret monterede og urammede bafler. De zig zag-formede bafler giver rummet et særligt designpræg samt muligheden for at udtrykke designet gennem form og farve. Bafler bruges primært, hvor det naturlige lys kommer ind i rummet via ovenlysvinduer.



FORMATER



Størrelse, mm	1800x300	1800x600
Speciel montage	•	•
Tykkelse (Tk.)	40	40
Montageanvisning	M417	M417

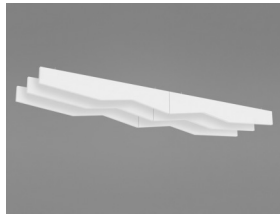

Solo Baffle ZigZag



Solo Baffle ZigZag/anker



Solo Baffle ZigZag/anker montage

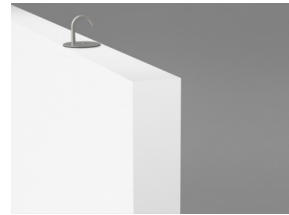

Solo Baffle ZigZag/krog

Akustik



Lydabsorption:

Testresultat i henhold til EN ISO 354:2003 NOTE: Viste resultatater kan ikke sammenlignes med resultater af ældre versioner af denne standard grundet uoverensstemmelser i testmetode. Klassificering i henhold til EN ISO 11654, og værdier for Noise Reduction Coefficient, NRC og Sound Absorption Average, SAA i henhold til ASTM C 423.

α_p , Praktisk absorptionsfaktor

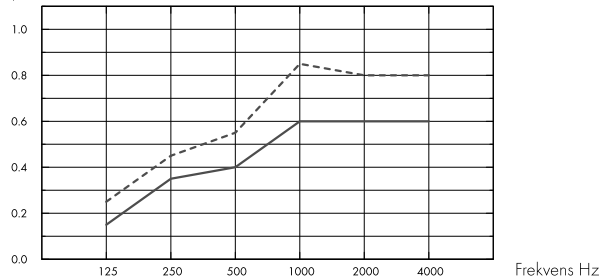

- Solo Baffle ZigZag 1800x300/200, afstand 600 mm, direkte monteret
- Solo Baffle ZigZag 1800x600/300, afstand 600 mm, direkte monteret
- o.d.s = tkh = total konstruktionshøjde

A_{eq} ækvivalent absorptionsareal pr. enhed (m² sabin)

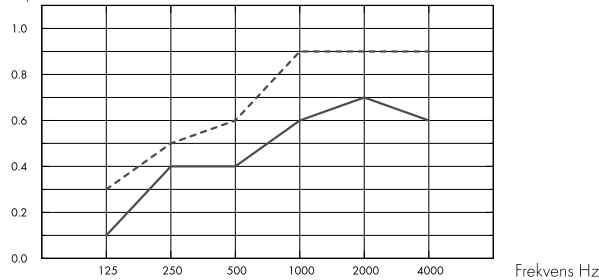

- Solo Baffle ZigZag 1800x300/200
- Solo Baffle ZigZag 1800x600/300
- o.d.s = tkh = total konstruktionshøjde

	Tk. mm	tkh mm	α_p , Praktisk absorptionsfaktor						α_w
			125 Hz	250 Hz	500 Hz	1000 Hz	2000 Hz	4000 Hz	
c600	40	300	0.15	0.35	0.40	0.60	0.60	0.60	0.50
c600	40	600	0.25	0.45	0.55	0.85	0.80	0.80	0.65

	Tk. mm	tkh mm	A_{eq} ækvivalent absorptionsareal pr. enhed (m ² sabin)					
			125 Hz	250 Hz	500 Hz	1000 Hz	2000 Hz	4000 Hz
c600	40	300	0.1	0.4	0.4	0.6	0.7	0.6
c600	40	600	0.3	0.5	0.6	0.9	0.9	0.9

	Tk. mm	tkh mm	NRC	SAA
c600	40	300	0.50	0.49
c600	40	600	0.65	0.65



Indeklima

Certifikat / Label

Eurofins Indoor Air Comfort®	IAC Gold
Fransk VOC	A+



Cradle to Cradle Certified®



Dette produkt er Cradle to Cradle Certificeret® på bronze niveau (version 4.0).



Material Health



Dette produkt har modtaget et C2C Certified Material Health Certificate™ på sølv niveau (standardversion 4.0). C2C Certified Material Health Certificate™ er en verifikation af sundheden og sikkerheden af et produkts sammensætning ved hjælp af Material Health-kravene i Cradle-to-Cradle Certified Product Standard.



Miljøpåvirkning

	kg CO ₂ equiv/m ²	Livscyklusstadier A1 til C4 fra EPD, i overensstemmelse med ISO 14025 / EN 15804
Solo Baffle ZigZag	11,13	



Circularity

Mindste indhold af genbrugsmateriale	57%
Genanvendelighed	Fuldt genanvendeligt



Brandsikkerhed

Land	Fire standard	Klasse	Kernen af glasuld er testet og klassificeret som ikke-brændbar i henhold til EN ISO 1182.
Europa	EN 13501-1	A2-s1,d0	



Fugtbestandighed

Klasse C, relativ fugtighed 95% og 30° C, i henhold til EN 13964: 2014



Visuelt udseende

White Frost, nærmeste NCS-farveprøve S 0500-N, 85% lysreflektion. Glans < 1.



Rengøring

Tåler daglig støvsugning og aftørring, samt ugentlig våd aftørring med klud.



Tilgængelighed

Panelerne er demonterbare.



Montage

Monteres i henhold til montageanvisning, installationsguide og CAD-tegninger. Information vedrørende min. total konstruktionshøjde, se Mængdespecifikation.



System vægt

	kg/m ²	Vægt oplysninger er vejledende og kan variere.
Solo Baffle	4,6	



Mekaniske egenskaber

Nyttelast skal fastgøres til loftet / underlaget.



CE

Ecophon loftsystemer er CE-mærket i henhold til den europæiske harmoniserede standard EN 13964: 2014. CE-mærkede byggevarer er omfattet af en DOP (Declaration of Performance), som gør det muligt for kunder og brugere at sammenligne de tilgængelige produkter på det europæiske marked.

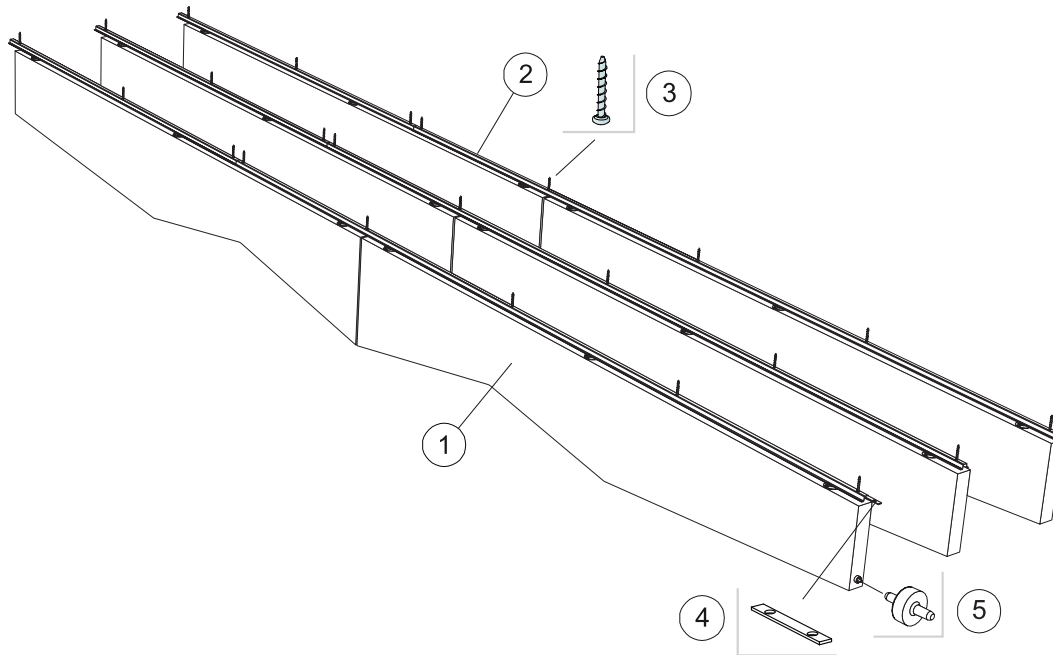

© Saint-Gobain Ecophon AB

MÆNGDESPECIFIKATION (EKSKLUSIV SPILD)

	Størrelse, mm	
	1800x300	1800x600
1 Solo Baffle ZigZag/anker, monteret c 300 mm.	1,9/m ²	1,9/m ²
2 Connect Baffle profil, monteres c 300 mm	3,3m/m ²	3,3m/m ²
3 Connect ankerskrue, monteres c 1200 mm	2,8/m ²	2,8/m ²
4 Connect samlelaske, monteres c 2400 mm	1,4/m ²	1,4/m ²
5 Connect styrestift, monteres c 1800 mm	1,9/m ²	1,9/m ²

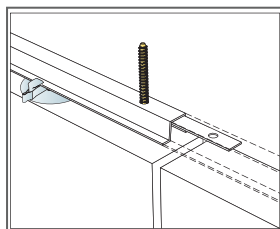

Montage af Connect profil samlelaske

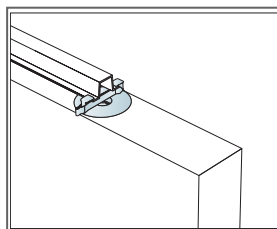

Baflerne er sikrede med clips

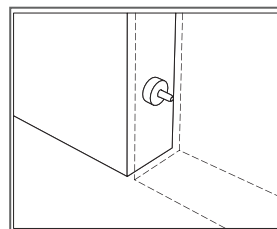

Connect styrestift anvendes til at holde afstand mellem panelerne

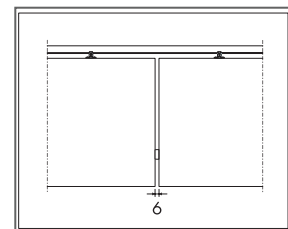

Tydeligt mellemrum på 6 mm mellem baffel med Connect styrestift

Ecophon Solo™ Baffle Wall

Ecophon Solo™ Baffle Wall er akustiske løsninger til vægge. Solo Baffle Wall er velegnet i bygninger, hvor du ønsker at udtrykke design og har frihed til at skabe mønstre med forskellige størrelser og farver. Med Connect™ Baffle vægmontering kan du nemt fastgøre bafflen til væggen.



Clientèle, Johannesburg, South Africa

FORMATER

	Størrelse, mm	1 200x200	1 200x300
	Speciel montage	•	•
	Tykkelse (Tk.)	40	40
	Montageanvisning	M420	M420

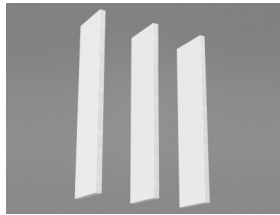

Solo Baffle Wall

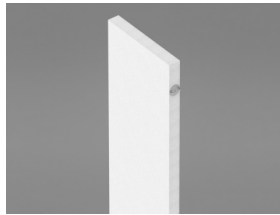

Solo Baffle/anker



Solo Baffle/anker med Connect Baffle vægbeslag

Akustik



For akustiske data på Baffle - se Solo Baffle

Indeklima



Certifikat / Label

Eurofins Indoor Air Comfort®

IAC Gold

Fransk VOC

A+



Cradle to Cradle Certified®



Dette produkt er Cradle to Cradle Certificeret® på bronze niveau (version 4.0).



Material Health



Dette produkt har modtaget et C2C Certified Material Health Certificate™ på sølv niveau (standardversion 4.0). C2C Certified Material Health Certificate™ er en verifikation af sundheden og sikkerheden af et produkts sammensætning ved hjælp af Material Health-kravene i Cradle-to-Cradle Certified Product Standard.



Miljøpåvirkning

	kg CO ₂ equiv/m ²
Solo Baffle & Solo Baffle Wall	10,11

Livscyklusstadier A1 til C4 fra EPD, i overensstemmelse med ISO 14025 / EN 15804



Circularity

Mindste indhold af genbrugsmateriale	57%
Genanvendelighed	Fuldt genanvendeligt



Brandsikkerhed

Land	Fire standard	Klasse
Europa	EN 13501-1	A2-s1,d0

Kernen af glasuld er testet og klassificeret som ikke-brændbar i henhold til EN ISO 1182.



Fugtbestandighed

Klasse C, relativ fugtighed 95% og 30° C, i henhold til EN 13964: 2014



Visuelt udseende

White Frost, nærmeste NCS-farveprøve S 0500-N, 85% lysreflektion. Glans < 1.



Rengøring

Tåler daglig støvsugning og aftørring, samt ugentlig våd aftørring med klud.



Tilgængelighed

Panelerne er demonterbare.



System vægt

	kg/m ²	Vægt oplysninger er vejledende og kan variere.
Solo Baffle	4,6	



Montage

Monteres i henhold til montageanvisning, installationsguide og CAD-tegninger. Information vedrørende min. total konstruktionshøjde, se Mængdespecifikation.



Mekaniske egenskaber

Nyttelast skal fastgøres til loftet / underlaget.



CE

Ecophon loftsystemer er CE-mærket i henhold til den europæiske harmoniserede standard EN 13964: 2014. CE-mærkede byggevarer er omfattet af en DOP (Declaration of Performance), som gør det muligt for kunder og brugere at sammenligne de tilgængelige produkter på det europæiske marked.



Miljøpåvirkning

	kg CO ₂ equiv/m ²	Livscyklusstadier A1 til C4 fra EPD, i overensstemmelse med ISO 14025 / EN 15804
Solo Baffle & Solo Baffle Wall	10,11	

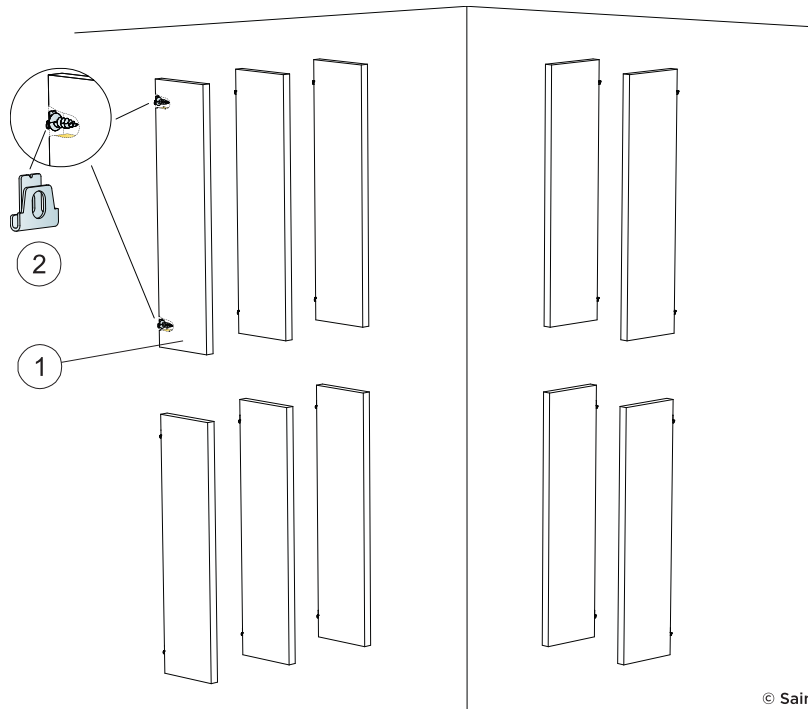

© Saint-Gobain Ecophon AB

MÆNGDESPECIFIKATION (EKSKLUSIV SPILD)

	Størrelse, mm	
	1200x200	1200x300
1 Solo Baffle/anker, monteret c.300 mm	2,8/m ²	2,8/m ²
2 Connect Baffle vægbeslag	2/panel	2/panel
$\Delta 1$ Min. total konstruktionshøjde: $\Delta 1$ 212mm / 312mm	-	-
$\Delta 2$ Min. total konstruktionshøjde: $\Delta 2$ 20mm	-	-
$\Delta 3$ Min. total konstruktionshøjde: $\Delta 3$ 2500mm	-	-

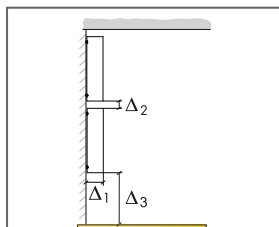

Se materialespecifikation

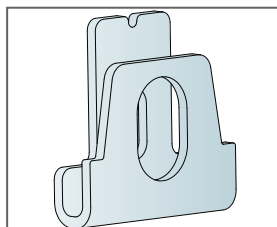

Connect Baffle vægbeslag

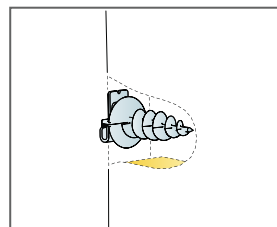

Udsnit af panel

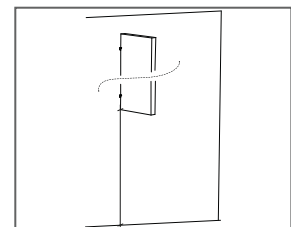

Montagehøjde min. 2,5 m

Ecophon Solo™ Matrix

Ecophon Solo™ Matrix er hurtigt og nemt at montere med en høj grad af nøjagtighed og en lang række designmuligheder. Hvert panel har en indbygget vippefunktion og kan nemt demonteres. Velegnet til større områder, hvor en høj dækningsgrad er påkrævet, men hvor heldækkende loftløsninger ikke er en mulighed.



FORMATER

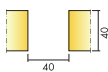

Størrelse, mm	600x1040	600x1200	600x2400	1200x1040	1200x1200	2400x1040	2400x1200
T24	•	•	•	•	•	•	•
Tykkelse [Tk.]	40	40	40	40	40	40	40
Montageanvisning	M502	M501, M503	M501, M503	M502	M501	M502	M501

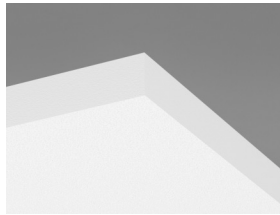

Solo Matrix panel

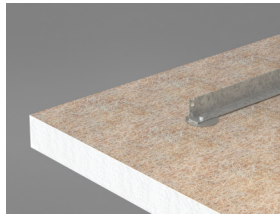

Connect Ivaerskinne på bagsiden af Solo Matrix Panel

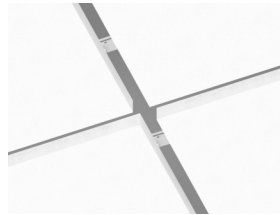

Solo Matrix system

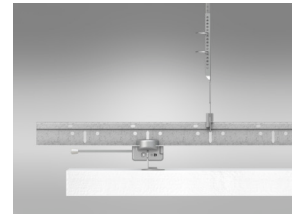

Udsnit af Solo Matrix system



Akustik

Det første diagram refererer til klynger >10 m². Det andet diagram refererer til klynger á 4 paneler (1200x1040 mm) i en række med mellemrum på 40 mm (M502). Såfremt Klyngerne er arrangeret i en række med afstand mellem klyngerne på <0,5 meter, vil Aeq per Klynge reduceres lidt.

Lydabsorption:

Testresultat i henhold til EN ISO 354. Klassificering i henhold til EN ISO 11654.

α_p , Praktisk absorptionsfaktor

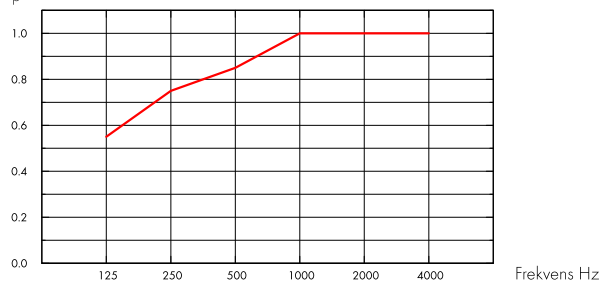

— Solo Matrix 40 mm, 300 mm o.d.s.
o.d.s = tkh = total konstruktionshøjde

A_{eq} , ækvivalent absorptionsareal pr. enhed (m² sabin)

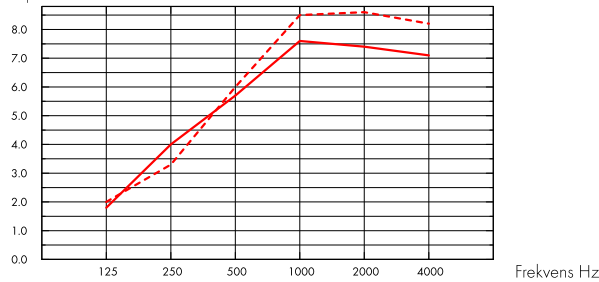

— Solo Matrix 40 mm (M502), 300 mm o.d.s.
- - - Solo Matrix 40 mm (M502), 600 mm o.d.s.
o.d.s = tkh = total konstruktionshøjde

Tk, mm	tkh mm	α_p , Praktisk absorptionsfaktor						α_w	Lydabsorptionsklasse
		125 Hz	250 Hz	500 Hz	1000 Hz	2000 Hz	4000 Hz		
40	300	0.55	0.75	0.85	1.00	1.00	1.00	0.95	A

Tk, mm	tkh mm	A_{eq} ækvivalent absorptionsareal pr. enhed (m ² sabin)					
		125 Hz	250 Hz	500 Hz	1000 Hz	2000 Hz	4000 Hz
40	300	1.8	4.0	5.7	7.6	7.4	7.1
40	600	2.0	3.3	6.0	8.5	8.6	8.2
40	1000	2.1	3.5	6.4	9.1	9.2	9.0



Indeklima

Certifikat / Label

Eurofins Indoor Air Comfort®	IAC Gold
Fransk VOC	A+



Cradle to Cradle Certified®



Dette produkt er Cradle to Cradle Certificeret® på bronze niveau (version 4.0).



Material Health



Dette produkt har modtaget et C2C Certified Material Health Certificate™ på sølv niveau (standardversion 4.0). C2C Certified Material Health Certificate™ er en verifikation af sundheden og sikkerheden af et produkts sammensætning ved hjælp af Material Health-kravene i Cradle-to-Cradle Certified Product Standard.



Miljøpåvirkning

	kg CO ₂ equiv/m ²	Livscyklusstadier A1 til C4 fra EPD, i overensstemmelse med ISO 14025 / EN 15804
Solo Matrix	7,52	



Circularity

Mindste indhold af genbrugsmateriale	62%
Genanvendelighed	Fuldt genanvendeligt



Brandsikkerhed

Land	Fire standard	Klasse
Europa	EN 13501-1	A2-s1,d0

Kernen af glasuld er testet og klassificeret som ikke-brændbar i henhold til EN ISO 1182.



Fugtbestandighed

Klasse C, relativ fugtighed 95% og 30° C, i henhold til EN 13964: 2014



Visuelt udseende

White Frost, nærmeste NCS-farveprøve S 0500-N, 85% lysreflektion. Glans < 1.



Rengøring

Tåler daglig støvsugning og aftørring, samt ugentlig vådaftørring med klud.



Tilgængelighed

Hver panel kan demonteres nedfra og har individuel vippefunktion.



Montage

For designmuligheder inklusiv montereretning og installationer, se montageanvisning, installationsguide og CAD-tegninger. Information vedrørende min. total konstruktionshøjde, se Mængdespecifikation.



System vægt

	kg/m ²	Vægt oplysninger er vejledende og kan variere.
Solo Matrix	3,5	
Solo Matrix + Connect Grid System	4,5	



Mekaniske egenskaber

Panelerne kan tage små belastninger med største hul diameter på 100 mm. Max belastning er 250g mellem de 2 tværskinner på panelet. For større last, se installationsguide



CE

Ecophon loftsystemer er CE-mærket i henhold til den europæiske harmoniserede standard EN13964: 2014. CE-mærkede byggevarer er omfattet af en DOP (Declaration of Performance), som gør det muligt for kunder og brugere at sammenligne de tilgængelige produkter på det europæiske marked.

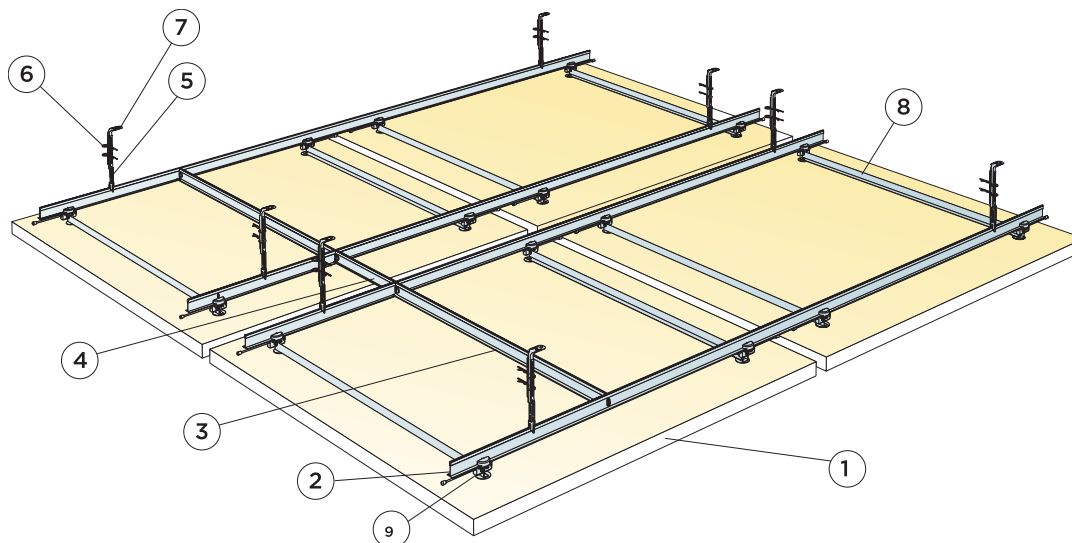

© Saint-Gobain Ecophon AB

MÆNGDESPECIFIKATION (EKSKLUSIV SPILD)

	Størrelse, mm			
	600x1200	600x2400	1200x1200	2400x1200
1 Solo Matrix	0,72m ² / loftplade	1,44m ² / loftplade	1,44m ² / loftplade	2,88m ² / loftplade
2 Connect T24 hovedprofil, monteres c 900 mm og 300 mm.	1,67m ² /m ²	1,67m ² /m ²	1,67m ² /m ²	1,67m ² /m ²
3 Connect T24 tværprofil, L=900 mm, monteres c 1800 mm.	0,42m ² /m ²	0,42m ² /m ²	0,42m ² /m ²	0,42m ² /m ²
4 Connect T24 tværprofil, L=300 mm, monteres c 2400 mm.	0,11m ² /m ²	0,11m ² /m ²	0,11m ² /m ²	0,11m ² /m ²
5 Connect Nonius nedre strop, monteret med en afstand på 1800 mm.	0,95m ² /m ²	0,95m ² /m ²	0,95m ² /m ²	0,95m ² /m ²
6 Connect split [2/stropfæste]	1,9/m ²	1,9/m ²	1,9/m ²	1,9/m ²
7 Connect Nonius øvre strop, monteret med en afstand på 1800 mm.	0,95m ² /m ²	0,95m ² /m ²	0,95m ² /m ²	0,95m ² /m ²
8 Connect tværskinne.	2/panel	4/panel	2/panel	3/panel
9 Connect panel-kobling.	4/panel	8/panel	4/panel	6/panel
Δ Min. total konstruktionshøjde: 305 mm.	-	-	-	-
Mængdespecifikationen er baseret på 40 mm mellemrum mellem alle panelerne.	-	-	-	-
Stabilisering kan blive nødvendigt, se installationsguide for yderligere informationer.	-	-	-	-

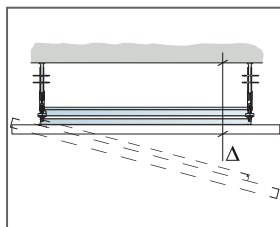

Se mængdespecifikation

Modular size	Exact size
600x1200	560x1160
600x2400	560x2360
1200x1200	1160x1160
2400x1200	2360x1160

Den venstre kolonne viser modul størrelser, og den højre eksakt størrelser.

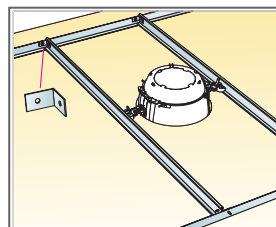

For længere installationer, anvend Connect tværprofil og vinkelbeslag.

Størrelse, mm	Nyttelast [N]	Belastningskapacitet [N]
600x1200x40	5	160
600x2400x40	5	160
1200x1200x40	5	160
2400x1200x40	5	160

Nyttelast/Belastningskapacitet

MONTAGEANVISNING (M502) FOR ECOPHON SOLO MATRIX I RÆKKER.

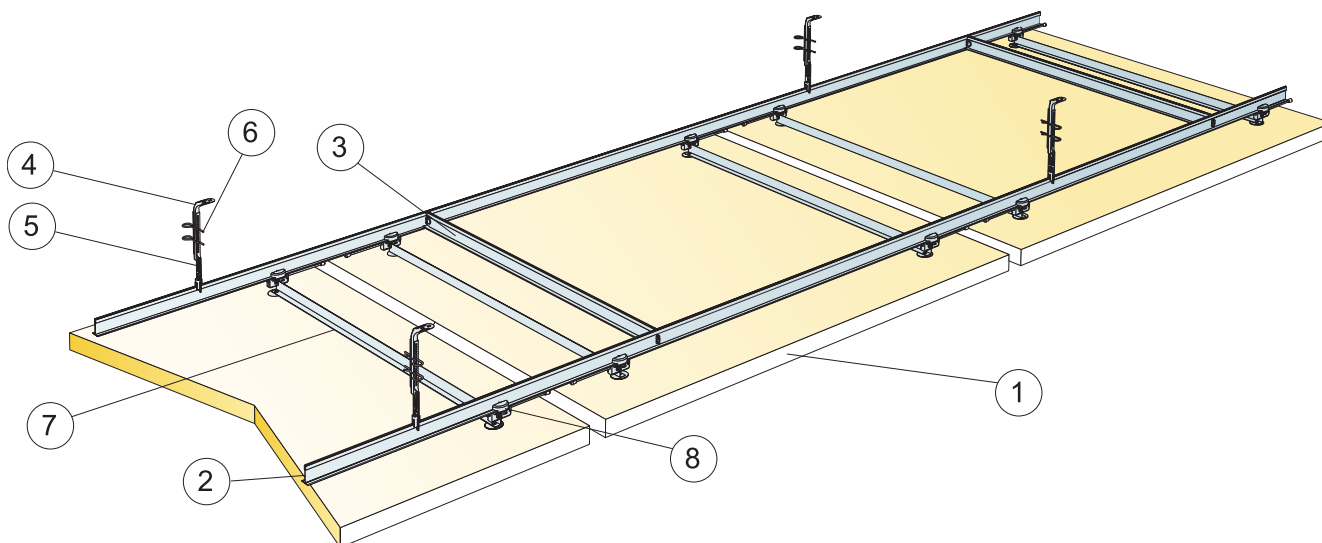

© Saint-Gobain Ecophon AB

MÆNGDESPECIFIKATION (EKSKLUSIV SPILD)

	Størrelse, mm		
	600x1040	1200x1040	2400x1040
1 Ecophon Master Matrix i rækker.	0,63m ² /panel	1,25m ² /panel	2,50m ² /panel
2 Connect T24 hovedprofil, monteres c 900 mm.	1,93m/m ²	1,93m/m ²	1,93m/m ²
3 Connect T24 tværprofil, L=900 mm, monteres c 1800 mm.	0,49m/m ²	0,49m/m ²	0,49m/m ²
4 Connect Nonius øvre strop, monteret med en afstand på 1800 mm.	1,07/m ²	1,07/m ²	1,07/m ²
5 Connect Nonius nedre strop, monteret med en afstand på 1800 mm.	1,07/m ²	1,07/m ²	1,07/m ²
6 Connect split (2/stropfæste)	2,14/m ²	2,14/m ²	2,14/m ²
7 Connect tværskinne.	2/panel	2/panel	3/panel
8 Connect panelkobling.	4/panel	4/panel	6/panel
Δ Min. total konstruktionshøjde: 305 mm.	-	-	-
Mængdespecifikationen er baseret på 40 mm mellemrum mellem panelerne i montereretningen.	-	-	-
Stabilisering kan blive nødvendig, se installationsguide for yderligere informationer.	-	-	-

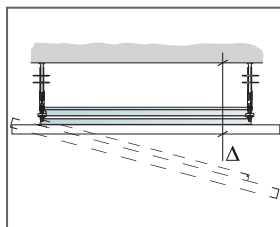

Se mængdespecifikation

Modular size	Exact size
600x1040	560x1000
1200x1040	1160x1000
2400x1040	2360x1000

Den venstre kolonne viser modul størrelser, og den højre eksakt størrelser.

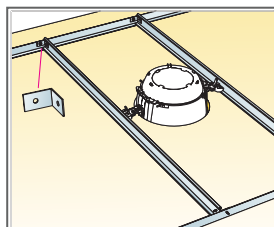

For tungere installationer, anvend Connect tværprofil og vinkelbeslag.

Størrelse, mm	Nyttelast [N]	Belastningskapacitet [N]
600x1040x40	5	160
1200x1040x40	5	160
2400x1040x40	5	160

Nyttelast/Belastningskapacitet

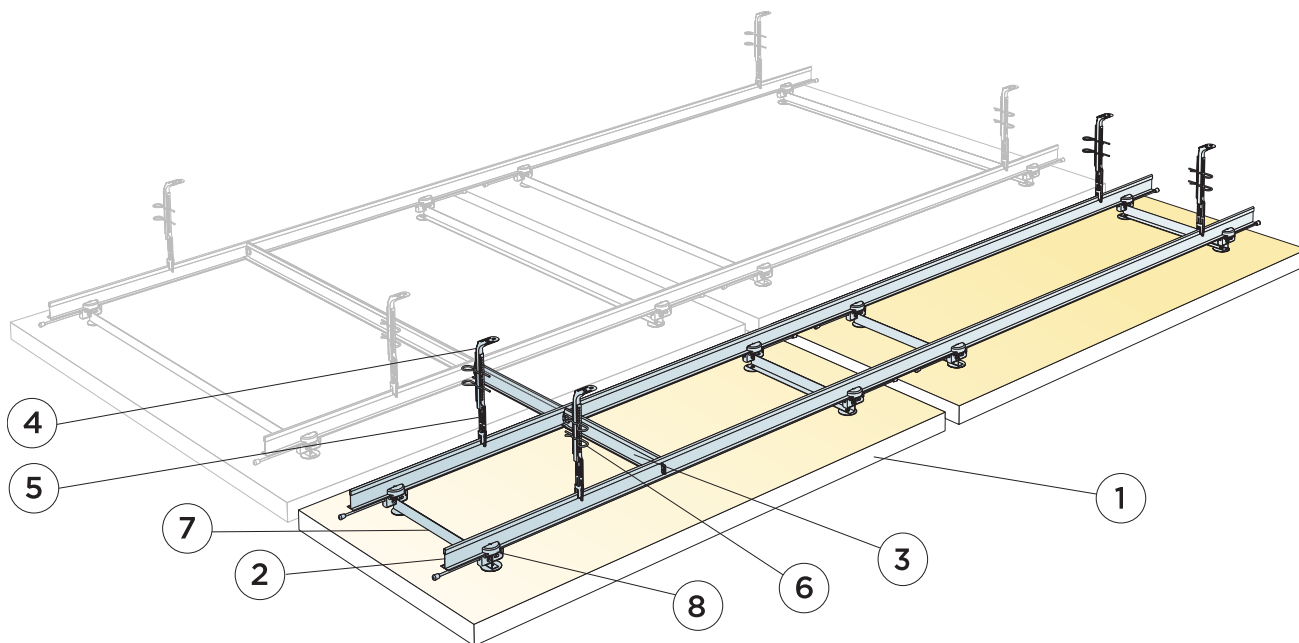

© Saint-Gobain Ecophon AB

MÆNGDESPECIFIKATION (EKSKLUSIV SPILD)

	Størrelse, mm	
	600x1200	600x2400
1 Solo Matrix	0,72m ² /panel	1,44m ² /panel
2 Connect T24 hovedprofil, monteres c 900 mm og 300 mm.	1,67m ² /m ²	1,67m ² /m ²
3 Connect T24 tværprofil, L=300 mm, monteres c 2400 mm.	0,11m ² /m ²	0,11m ² /m ²
4 Connect Nonius øvre strop, monteret med en afstand på 1800 mm.	0,95/m ²	0,95/m ²
5 Connect Nonius nedre strop, monteret med en afstand på 1800 mm.	0,95/m ²	0,95/m ²
6 Connect split (2/stropfæste)	1,9/m ²	1,9/m ²
7 Connect tværskinne.	2/panel	4/panel
8 Connect panel-kobling.	4/panel	8/panel
Δ Min. total konstruktionshøjde: 305 mm.	-	-
Mængdespecifikationen er baseret på 40 mm mellemrum mellem alle panelerne.	-	-
Stabilisering kan blive nødvendigt, se installationsguide for yderligere informationer.	-	-

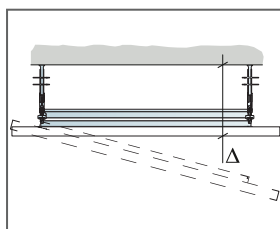

Se mængdespecifikation

Modular size	Exact size
600x1200	560x1160
600x2400	560x2360
1200x1200	1160x1160
2400x1200	2360x1160

Den venstre kolonne viser modul størrelser, og den højre eksakt størrelser.

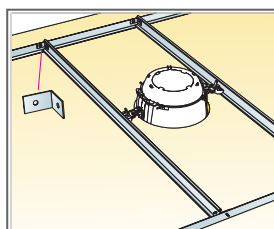

For længere installationer, anvend Connect tværprofil og vinkelbeslag.

Størrelse, mm	Nyttelast [N]	Belastningskapacitet [N]
600x1200x40	5	160
600x2400x40	5	160

Nyttelast/Belastningskapacitet

Ecophon Solo™ Rectangle Line

Solo Rectangle Line er en frithængende enhed med et integreret armatur. En kombination af Ecophon Solo™ Rectangle og Ecophon Line™. Dette er et produkt, der er velegnet til forskellige applikationer såsom åbne planløsninger, frokost-områder eller konference- og mødelokaler.



Ecophon Head Office, Hyllinge, Sweden

FORMATER



Størrelse, mm	2400x1200
Speciel montage	•
Tykkelse (Tk.)	40
Montageanvisning	M521

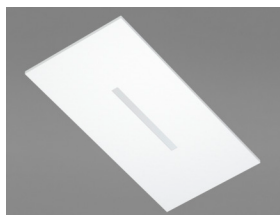

Solo Rectangle Line



Solo panel



Nedhængning med Connect justerbar wire og Connect absorberankers

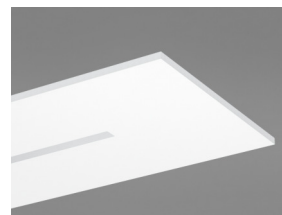

Solo panel med Line

Akustik



For akustiske data på panelet - se Solo Rectangle.



Belysningsdata

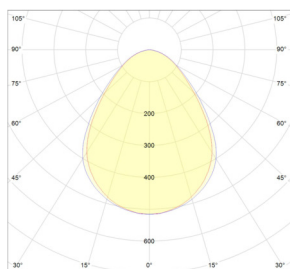

System effekt: 29,4W
Lyskilde: LED 26,7 W
Lysstrøm: 2337 lm
Lyseffekt: 87,5 lm/W
Farvetemperatur: 4000K
Farvegengivelses index: ≥ 80 Ra
Farve tolerance: ≤ 3 MacAdam SDCM
Lysudbytte (LOR): 100%
Lysfordeling op/ned: 0/100
Forventet livslængde: L90 > 50 000 h
Forventet livslængde: L70 > 100 000 h



Tilslutning

Standard tænd/sluk elektronisk HF ballast leveret med 2,5 meter ledning 3x0,75 mm² og stik med jord. SwitchDIM/DAI ballast leveres uden ledning.



Elektrisk data

220-240 V, 50-60 Hz, effektfaktor $\cos \phi > 0,98$. Elektronisk HF ballast eller elektronisk HF dæmper for digital regulering. Lyskilde: LED modul på total 26,7W.



El-godkendelser

IP20, Klasse 1.



Circularity

Mindste indhold af genbrugsmateriale	57%
Genanvendelighed	Fuldt genanvendeligt



Brandsikkerhed

Land	Fire standard	Klasse
Europa	EN 13501-1	A2-s1,d0

Kernen af glasuld er testet og klassificeret som ikke-brændbar i henhold til EN ISO 1182.



Fugtbestandighed

Klasse A, relativ fugtighed 70% og 25° C, i henhold til EN 13964: 2014



Visuelt udseende

White Frost, nærmeste NCS-farveprøve S 0500-N, 85% lysreflektion. Glans < 1.



Rengøring

Tåler daglig støvsugning og aftørring, samt ugentlig våd aftørring med klud.



Tilgængelighed

Panelerne er demonterbare.



Montage

Monteres i henhold til montageanvisning, installationsguide og CAD-tegninger. Information vedrørende min. total konstruktionshøjde, se Mængdespecifikation.



CE

Ecophon loftsystemer er CE-mærket i henhold til den europæiske harmoniserede standard EN 13964: 2014. CE-mærkede byggevarer er omfattet af en DOP (Declaration of Performance), som gør det muligt for kunder og brugere at sammenligne de tilgængelige produkter på det europæiske marked.

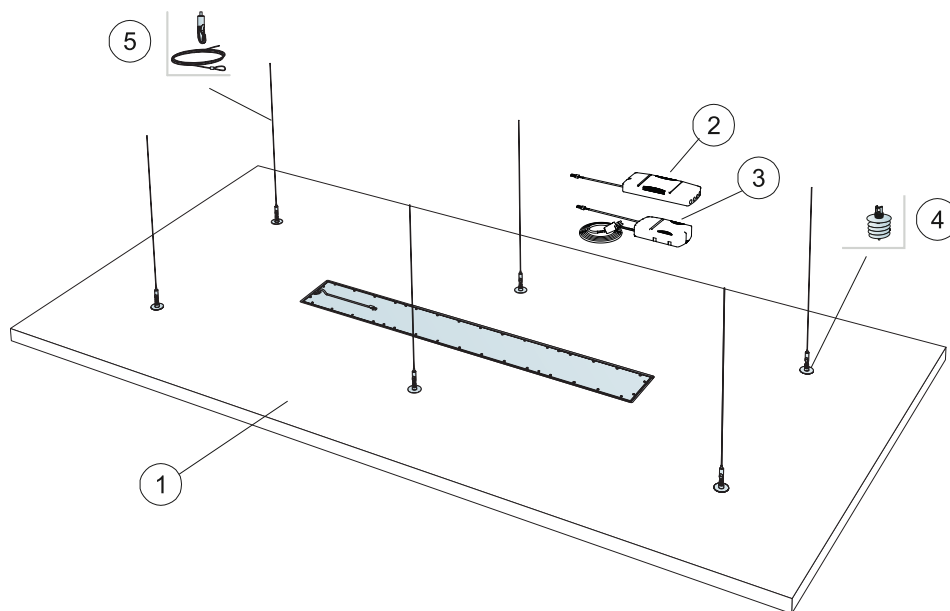

© Saint-Gobain Ecophon AB

MÆNGDESPECIFIKATION (EKSKLUSIV SPILD)

	Størrelse, mm
	2400x1200
1 Solo Rectangle Line	2,88/m ²
2 Ecophon Dot/Square/Line standard On/Off Ballast (inkluderet) (Alt.1)	-
3 Ecophon Dot/Square/Line SwitchDIM/DAI Ballast (inkluderet) (Alt.2)	-
4 Connect absorbt anker	6/panel
5 Connect justerbar wire (Alt.1)	6/panel
Δ Min. total konstruktionshøjde: 140 mm	-
Når der vælges standard tænd/sluk-ballast, skal der kun slutte til en afbryder. Når der bruges SwitchDIM/DAI ballast, der forbinder SwitchDIM-funktionen, skal der bruge en fjederbelastet afbryder.	-
Ved valg af switchDIM / DAI ballast og udnyttelse af DAI-funktionen, tilsluttes blot til en DAI kompatibel controller.	-

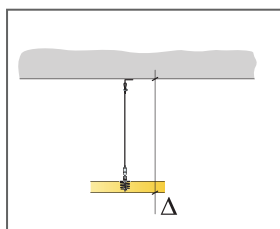

Se mængdespecifikation

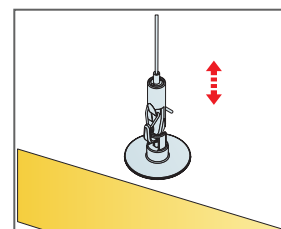

Let justerbar nedhængning med Connect justerbar wire



Ecophon Solo™ Circle Akutex HS

Ecophon Solo™ Circle Akutex HS er en vandafvisende frithængende enhed, der giver mange fantastiske designmuligheder. Solo Circle Akutex HS er primært beregnet til områder ved svømmebassiner, hvor der er høj fugtighed og lejlighedsvis direkte vandsprøjt.



FORMATER



Størrelse, mm	Ø800	Ø1200
Speciel montage	•	•
Tykkelse (Tk.)	40	40
Montageanvisning	M437C4	M442C4



Solo Circle Akutex HS



Solo Circle Akutex HS panel



Nedhængt med Connect justerbar wire C4 og Connect absorber-anker

Akustik



Værdierne i diagrammet henviser til en enkelt enhed. Hvis enhederne arrangeres i en klynge med afstande på mindre en 0,5 meter, bliver A_{eq} pr. enhed let reduceret.

Lydabsorption:

Testresultater i henhold til EN ISO 354.

A_{eq} ækvivalent absorptionsareal pr. enhed (m^2 sabin)

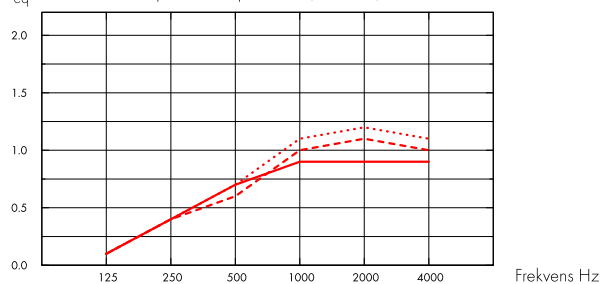

- Solo Circle/Akutex HS Ø800, 200 mm o.d.s.
 - - - Solo Circle/Akutex HS Ø800, 400 mm o.d.s.
 - ... Solo Circle/Akutex HS Ø800, 1000 mm o.d.s.
- o.d.s = tkh = total konstruktionshøjde

A_{eq} ækvivalent absorptionsareal pr. enhed (m^2 sabin)

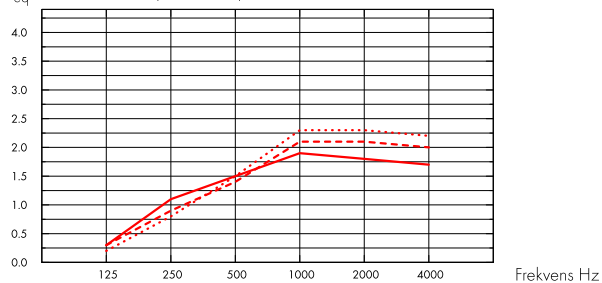

- Solo Circle/Akutex HS Ø1200, 200 mm o.d.s.
 - - - Solo Circle/Akutex HS Ø1200, 400 mm o.d.s.
 - ... Solo Circle/Akutex HS Ø1200, 1000 mm o.d.s.
- o.d.s = tkh = total konstruktionshøjde

	Tk. mm	tkh mm	A_{eq} ækvivalent absorptionsareal pr. enhed (m^2 sabin)					
			125 Hz	250 Hz	500 Hz	1000 Hz	2000 Hz	4000 Hz
Ø800	40	200	0.1	0.4	0.7	0.9	0.9	0.9
Ø800	40	400	0.1	0.4	0.6	1.0	1.1	1.0
Ø800	40	1000	0.1	0.4	0.7	1.1	1.2	1.1

	Tk. mm	tkh mm	A_{eq} ækvivalent absorptionsareal pr. enhed (m^2 sabin)					
			125 Hz	250 Hz	500 Hz	1000 Hz	2000 Hz	4000 Hz
Ø1200	40	200	0.3	1.1	1.5	1.9	1.8	1.7
Ø1200	40	400	0.3	0.9	1.4	2.1	2.1	2.0
Ø1200	40	1000	0.2	0.8	1.5	2.3	2.3	2.2



Indeklima

Certifikat / Label

Eurofins Indoor Air Comfort®	IAC Gold
Fransk VOC	A+



Cradle to Cradle Certified®



Dette produkt er Cradle to Cradle Certificeret® på bronze niveau (version 4.0).



Material Health



Dette produkt har modtaget et C2C Certified Material Health Certificate™ på sølv niveau (standardversion 4.0). C2C Certified Material Health Certificate™ er en verifikation af sundheden og sikkerheden af et produkts sammensætning ved hjælp af Material Health-kravene i Cradle-to-Cradle Certified Product Standard.



Miljøpåvirkning

	kg CO ₂ equiv/m ²	Livscyklusstadier A1 til C4 fra EPD, i overensstemmelse med ISO 14025 / EN 15804
Solo Circle/Akutex HS	10,87	



Circularity

Mindste indhold af genbrugsmateriale	54%
Genanvendelighed	Fuldt genanvendeligt



Brandsikkerhed

Land	Fire standard	Klasse	Kernen af glasuld er testet og klassificeret som ikke-brændbar i henhold til EN ISO 1182.
Europa	EN 13501-1	A2-s1,d0	



Fugtbestandighed

Testet for klasse C, relativ luftfugtighed 95% og 30 °C, i henhold til EN 13964:2014



Visuelt udseende

White 500, nærmeste NCS farveprøve S 0500-N, 84% lysreflektion.



Rengøring

Tåler daglig støvsugning og aftørring, samt ugentlig våd aftørring med klud.



Tilgængelighed

Panelerne er demonterbare.



Montage

Monteres i henhold til montageanvisning, installationsguide og CAD-tegninger. Information vedrørende min. total konstruktionshøjde, se Mængdespecifikation.



System vægt

	kg/m ²	Vægt oplysninger er vejledende og kan variere.
Solo Circle/Akutex HS	4,9	



Mekaniske egenskaber

Ingen yderligere belastning er tilladt.



CE

Ecophon loftsystemer er CE-mærket i henhold til den europæiske harmoniserede standard EN 13964: 2014. CE-mærkede byggevarer er omfattet af en DOP (Declaration of Performance), som gør det muligt for kunder og brugere at sammenligne de tilgængelige produkter på det europæiske marked.

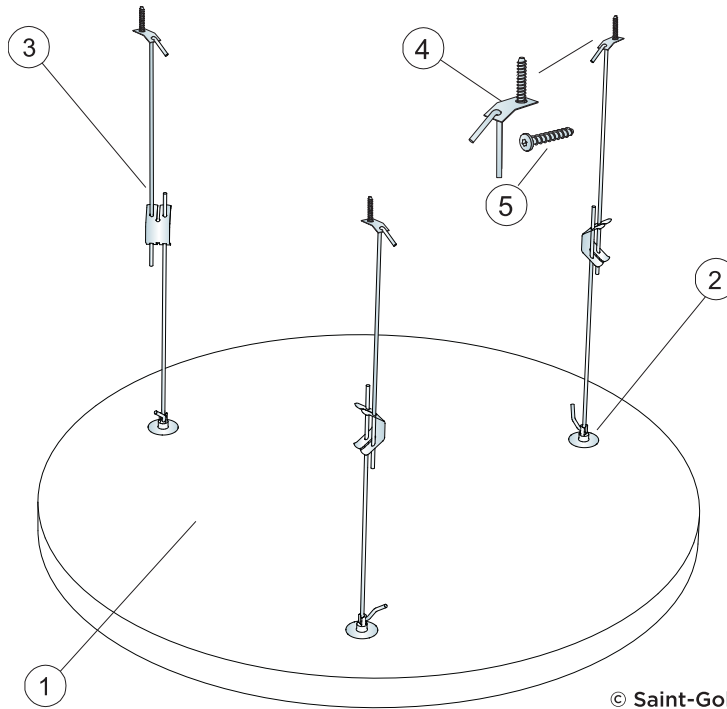

© Saint-Gobain Ecophon AB

MÆNGDESPECIFIKATION (EKSKLUSIV SPILD)

		Størrelse, mm
		Ø800
1	Solo Circle Akutex HS	0,5m ² /panel
2	Connect absorbt anker	3/panel
3	Connect justerbar strop C4	3/panel
4	Connect montagebeslag C4	3/panel
5	Connect ankerskrue C4	3/panel
Δ Min. total konstruktionshøjde: Δ 410 mm		-

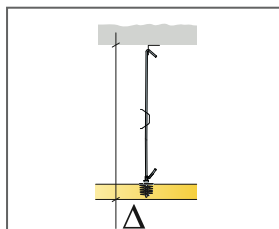

Se mængdespecifikation

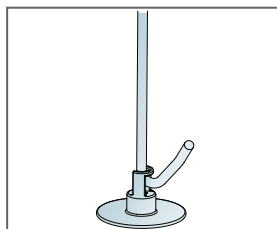

Connect justerbar strop C4, monteret med Connect absorbt-anker.

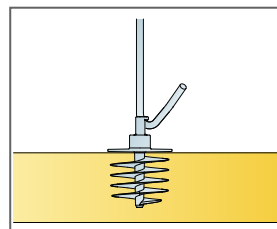

Connect absorbt-anker monteret på panel.

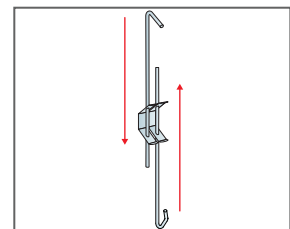

Justerbar med Connect justerbar strop C4

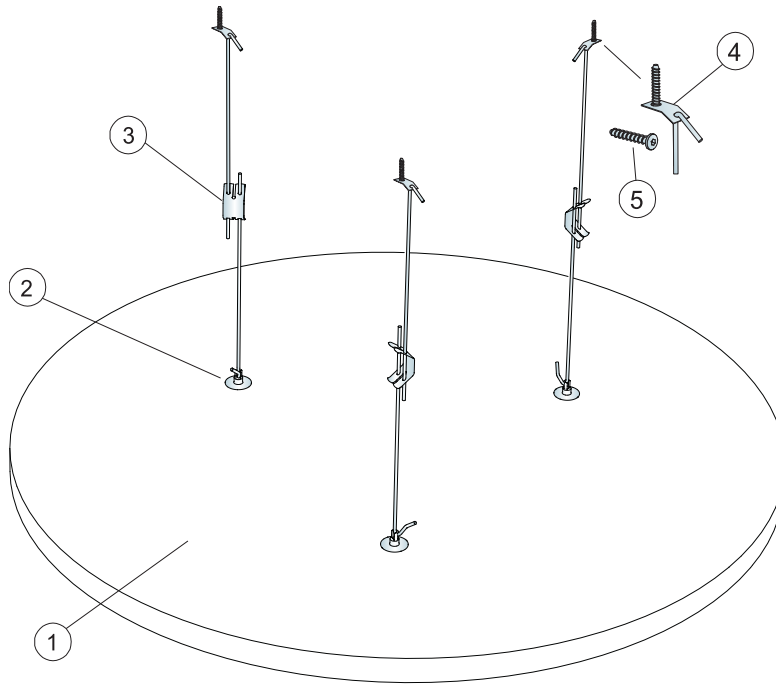

© Saint-Gobain Ecophon AB

MÆNGDESPECIFIKATION (EKSKLUSIV SPILD)

		Størrelse, mm
		Ø1200
1	Solo Circle Akutex HS	1,13m ² /panel
2	Connect absorberent anker	3/panel
3	Connect justerbar strop C4	3/panel
4	Connect montagebeslag C4	3/panel
5	Connect ankerskrue C4	3/panel
Δ Min. total konstruktionshøjde: Δ 410 mm		-

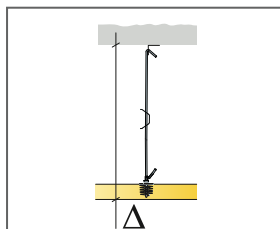

Se mængdespecifikation

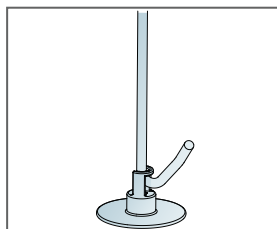

Connect justerbar strop C4, monteret med Connect absorberent-anker.

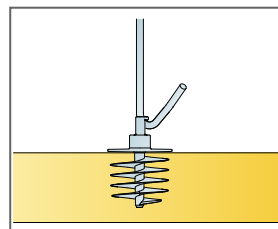

Connect absorberent-anker monteret på panel.

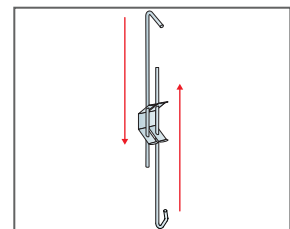

Justerbar med Connect justerbar strop C4



Ecophon Solo™ Square Akutex HS

Ecophon Solo™ Square Akutex HS er en vandafvisende frithængende enhed, der giver mange fantastiske designmuligheder. Solo Square Akutex HS er primært beregnet til områder ved svømmebassiner, hvor der er høj fugtighed og lejlighedsvis direkte vandsprøjt.



FORMATER

<input type="checkbox"/>	Størrelse, mm	1200x1200
	Speciel montage	•
	Tykkelse (Tk.)	40
	Montageanvisning	M438C4

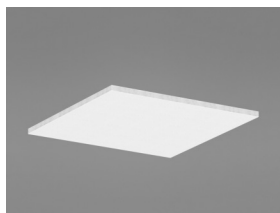

Solo Square Akutex HS

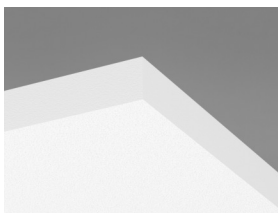

Solo Rectangle Akutex HS panel



Nedhængt med Connect justerbar wire C4 og Connect absorber-anker

Akustik



Værdierne i diagrammet henviser til en enkelt enhed. Hvis enhederne placeres i en klynge med afstande på mindre end 0,5 meter, bliver A_{eq} pr. enhed let reduceret.

Lydabsorption:

Testresultater i henhold til EN ISO 354.

A_{eq} ækvivalent absorptionsareal pr. enhed (m^2 sabin)

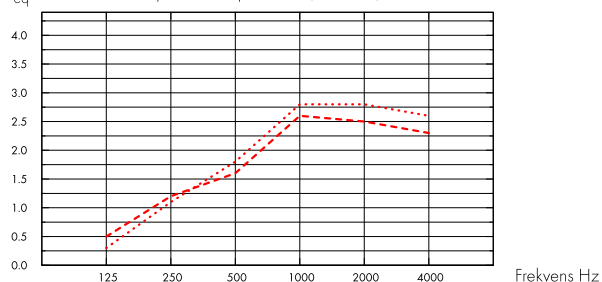

--- Solo Square 1200x1200/Akutex HS, 400 mm o.d.s.

... Solo Square 1200x1200/Akutex HS, 1000 mm o.d.s.

o.d.s = t_{kh} = total konstruktionshøjde

Tk. mm	t _{kh} mm	A_{eq} ækvivalent absorptionsareal pr. enhed (m^2 sabin)					
		125 Hz	250 Hz	500 Hz	1000 Hz	2000 Hz	4000 Hz
40	400	0.5	1.2	1.6	2.6	2.5	2.3
40	1000	0.3	1.1	1.8	2.8	2.8	2.6



Indeklima

Certifikat / Label

Eurofins Indoor Air Comfort®

IAC Gold

Fransk VOC

A+



Cradle to Cradle Certified®



Dette produkt er Cradle to Cradle Certificeret® på bronze niveau (version 4.0).



Material Health



Dette produkt har modtaget et C2C Certified Material Health Certificate™ på sølv niveau (standardversion 4.0). C2C Certified Material Health Certificate™ er en verifikation af sundheden og sikkerheden af et produkts sammensætning ved hjælp af Material Health-kravene i Cradle-to-Cradle Certified Product Standard.



Miljøpåvirkning

	kg CO ₂ equiv/m ²
Solo Square	9,37

Livscyklusstadier A1 til C4 fra EPD, i overensstemmelse med ISO 14025 / EN 15804



Circularity

Mindste indhold af genbrugsmateriale	54%
Genanvendelighed	Fuldt genanvendeligt



Brandsikkerhed

Land	Fire standard	Klasse
Europa	EN 13501-1	A2-s1,d0

Kernen af glasuld er testet og klassificeret som ikke-brændbar i henhold til EN ISO 1182.



Fugtbestandighed

Testet for klasse C, relativ luftfugtighed 95% og 30 °C, i henhold til EN 13964:2014



Visuelt udseende

White 500, nærmeste NCS farveprøve S 0500-N, 84% lysreflektion.



Rengøring

Tåler daglig støvsugning og aftørring, samt ugentlig vådaftørring med klud.



Tilgængelighed

Panelerne er demonterbare.



Montage

Monteres i henhold til montageanvisning, installationsguide og CAD-tegninger. Information vedrørende min. total konstruktionshøjde, se Mængdespecifikation.



System vægt

	kg/m ²
Solo Square/Akutex HS	4,9

Vægt oplysninger er vejledende og kan variere.



Mekaniske egenskaber

Ingen yderligere belastning er tilladt.



CE

Ecophon loftsystemer er CE-mærket i henhold til den europæiske harmoniserede standard EN 13964: 2014. CE-mærkede byggevarer er omfattet af en DOP (Declaration of Performance), som gør det muligt for kunder og brugere at sammenligne de tilgængelige produkter på det europæiske marked.

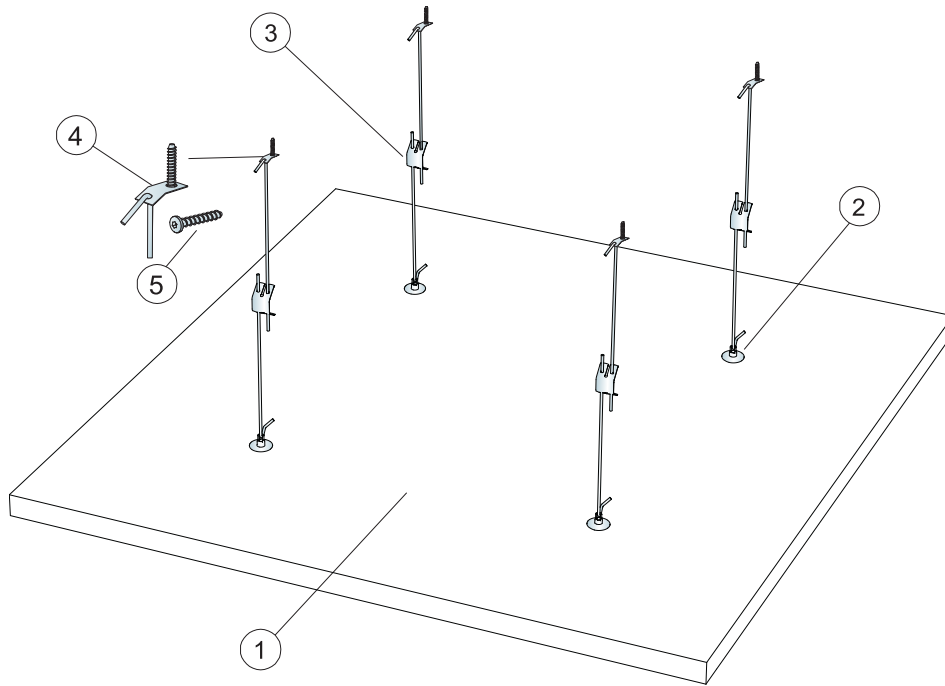

© Saint-Gobain Ecophon AB

MÆNGDESPECIFIKATION (EKSKLUSIV SPILD)

		Størrelse, mm
		1200x1200
1	Solo Square Akutex HS	1,44m ² /panel
2	Connect absorberet anker	4/panel
3	Connect justerbar strop C4	4/panel
4	Connect montagebeslag C4	4/panel
5	Connect ankerskrue C4	4/panel
Δ Min. total konstruktionshøjde: Δ 410 mm		-

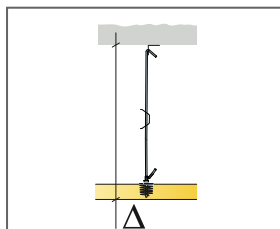

Se mængdespecifikation

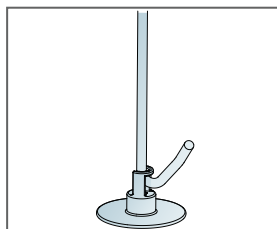

Connect justerbar strop C4, monteret med Connect absorberet-anker.

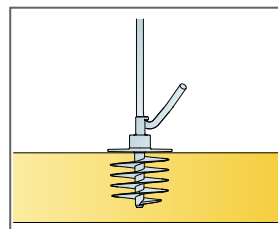

Connect absorberet-anker monteret på panel.

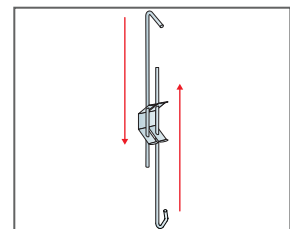

Justerbar med Connect justerbar strop C4



Ecophon Solo™ Rectangle Akutex HS

Ecophon Solo™ Rectangle Akutex HS er en vandafvisende frithængende enhed, der giver mange fantastiske designmuligheder. Solo Rectangle Akutex HS er primært beregnet til områder ved svømmebassiner, hvor der er høj fugtighed og lejlighedsvis direkte vandsprøjt.



FORMATER

	Størrelse, mm	1800x1200	2400x1200
	Speciel montage	•	•
	Tykkelse (Tk.)	40	40
	Montageanvisning	M436C4	M441C4

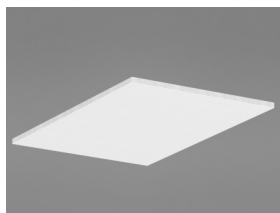

Solo Rectangle Akutex HS

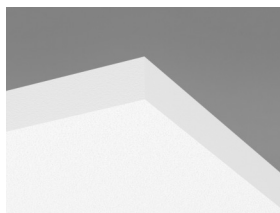

Solo Rectangle Akutex HS panel



Nedhængt med Connect justerbar wire C4 og Connect absorber-anker

Akustik



Værdierne i diagrammet refererer til en enkelt enhed. Hvis enheden placeres i en klynge med afstande mellem enhederne på under 0,5 meter, bliver A_{eq} pr. enhed let reduceret.

Lydabsorption:

Testresultater i henhold til EN ISO 354.

A_{eq} ækvivalent absorptionsareal pr. enhed (m^2 sabin)

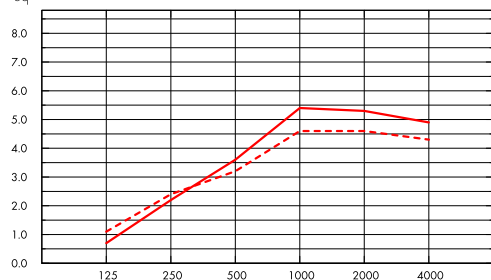

- Solo Rectangle 2400x1200/Akutex HS, 400 mm o.d.s.
 - Solo Rectangle 2400x1200/Akutex HS, 1000 mm o.d.s.
- o.d.s = tkh = total konstruktionshøjde

Frekvens Hz

A_{eq} ækvivalent absorptionsareal pr. enhed (m^2 sabin)

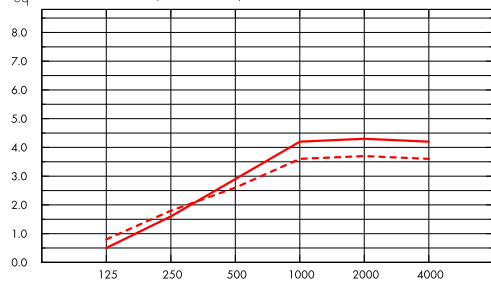

- Solo Rectangle 1800x1200/Akutex HS, 400 mm o.d.s.
 - Solo Rectangle 1800x1200/Akutex HS, 1000 mm o.d.s.
- o.d.s = tkh = total konstruktionshøjde

Frekvens Hz

	Tk. mm	tkh mm	A_{eq} ækvivalent absorptionsareal pr. enhed (m^2 sabin)					
			125 Hz	250 Hz	500 Hz	1000 Hz	2000 Hz	4000 Hz
2400x1200	40	400	1.1	2.4	3.2	4.6	4.6	4.3
2400x1200	40	1000	0.7	2.2	3.6	5.4	5.3	4.9
1800x1200	40	400	0.8	1.8	2.6	3.6	3.7	3.6
1800x1200	40	1000	0.5	1.6	2.9	4.2	4.3	4.2

Indeklima



Certifikat / Label

Eurofins Indoor Air Comfort®

IAC Gold

Fransk VOC

A+



Cradle to Cradle Certified®



Dette produkt er Cradle to Cradle Certificeret® på bronze niveau (version 4.0).



Material Health



Dette produkt har modtaget et C2C Certified Material Health Certificate™ på sølv niveau (standardversion 4.0). C2C Certified Material Health Certificate™ er en verifikation af sundheden og sikkerheden af et produkts sammensætning ved hjælp af Material Health-kravene i Cradle-to-Cradle Certified Product Standard.



Miljøpåvirkning

	kg CO ₂ equiv/m ²	Livscyklusstadier A1 til C4 fra EPD, i overensstemmelse med ISO 14025 / EN 15804
Solo Rectangle	9,64	



Circularity

Mindste indhold af genbrugsmateriale	54%
Genanvendelighed	Fuldt genanvendeligt



Brandsikkerhed

Land	Fire standard	Klasse
Europa	EN 13501-1	A2-s1,d0

Kernen af glasuld er testet og klassificeret som ikke-brændbar i henhold til EN ISO 1182.



Fugtbestandighed

Testet for klasse C, relativ luftfugtighed 95% og 30 °C, i henhold til EN 13964:2014



Visuelt udseende

White 500, nærmeste NCS farveprøve S 0500-N, 84% lysreflektion.



Rengøring

Tåler daglig støvsugning og aftørring, samt ugentlig vådaftørring med klud.



Tilgængelighed

Panelerne er demonterbare.



Montage

Monteres i henhold til montageanvisning, installationsguide og CAD-tegninger. Information vedrørende min. total konstruktionshøjde, se Mængdespecifikation.



System vægt

	kg/m ²	Vægt oplysninger er vejledende og kan variere.
Solo Rectangle Akutex HS	4,9	



Mekaniske egenskaber

Ingen yderligere belastning er tilladt.



CE

Ecophon loftsystemer er CE-mærket i henhold til den europæiske harmoniserede standard EN 13964: 2014. CE-mærkede byggevarer er omfattet af en DOP (Declaration of Performance), som gør det muligt for kunder og brugere at sammenligne de tilgængelige produkter på det europæiske marked.

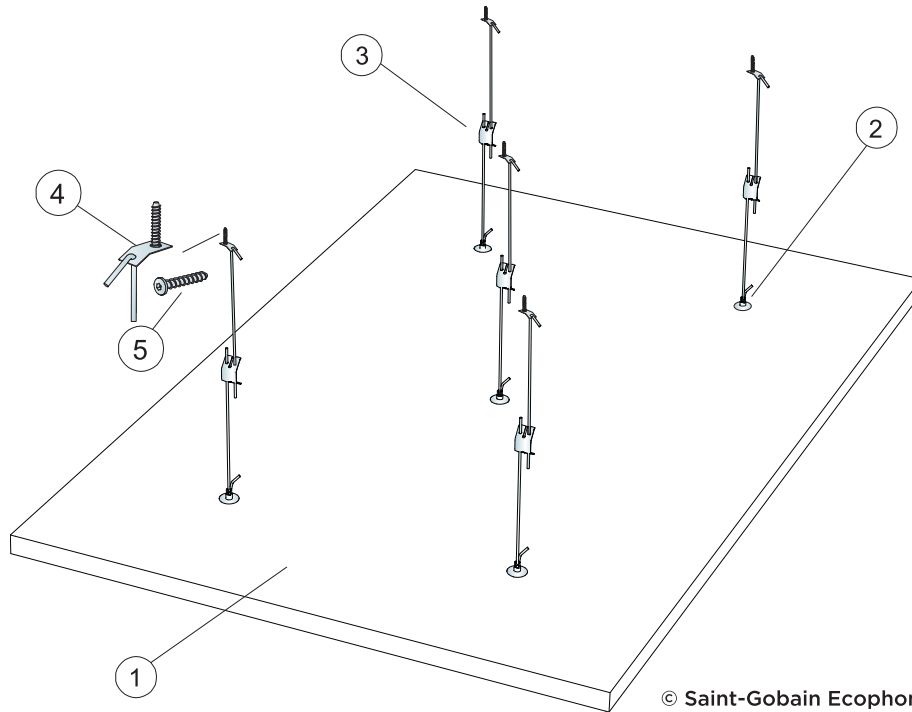

© Saint-Gobain Ecophon AB

MÆNGDESPECIFIKATION (EKSKLUSIV SPILD)

		Størrelse, mm
		1800x1200
1	Solo Rectangle Akutex HS	2,16m ² /panel
2	Connect absorberent anker	5/panel
3	Connect justerbar strop C4	5/panel
4	Connect montagebeslag C4	5/panel
5	Connect ankerskrue C4	5/panel
Δ Min. total konstruktionshøjde: Δ 410 mm		-

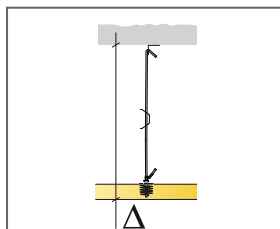

Se mængdespecifikation

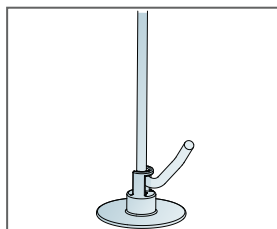

Connect justerbar strop C4, monteret med Connect absorberent-anker.

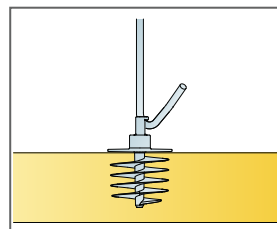

Connect absorberent-anker monteret på panel.

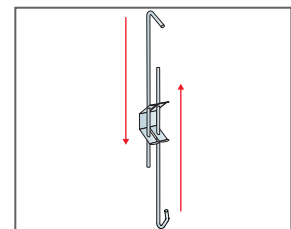

Justerbar med Connect justerbar strop C4

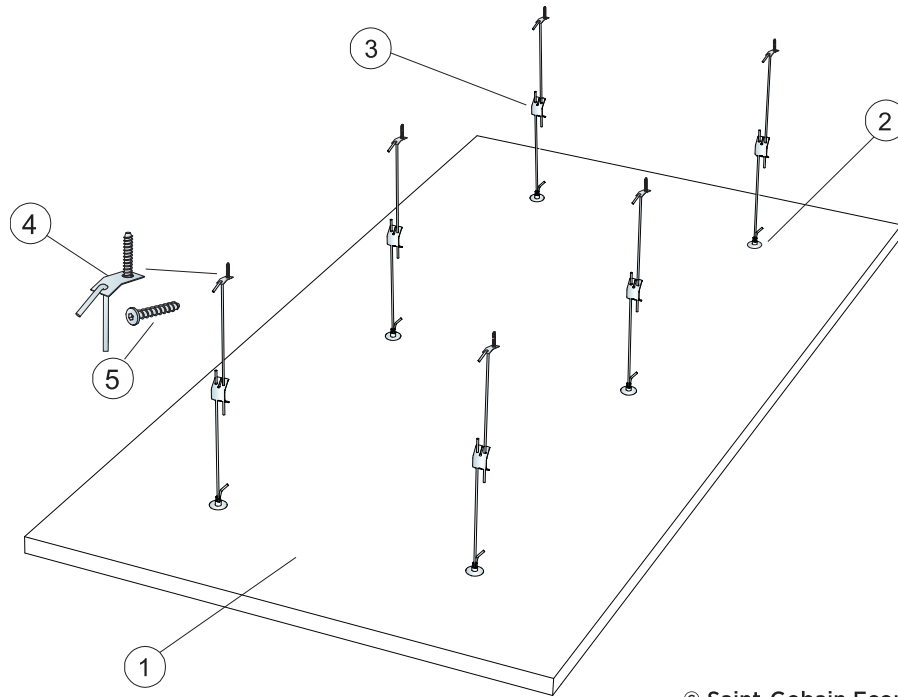

© Saint-Gobain Ecophon AB

MÆNGDESPECIFIKATION (EKSKLUSIV SPILD)

		Størrelse, mm
		2400x1200
1	Solo Rectangle Akutex HS	2,88m ² /panel
2	Connect absorbt anker	6/panel
3	Connect justerbar strop C4	6/panel
4	Connect montagebeslag C4	6/panel
5	Connect ankerskrue C4	6/panel
Δ Min. total konstruktionshøjde: Δ 410 mm		-

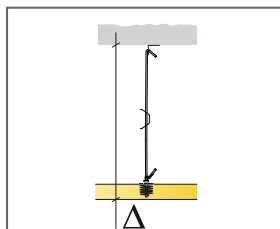

Se mængdespecifikation

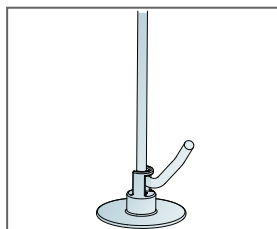

Connect justerbar strop C4, monteret med Connect absorbt-anker.

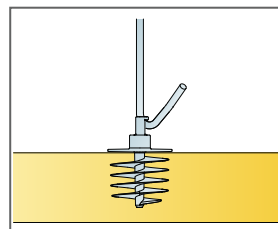

Connect absorbt-anker monteret på panel.

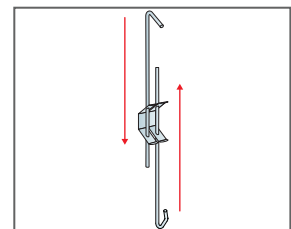

Justerbar med Connect justerbar strop C4

Ecophon Solo™ Lite Square

Ecophon Solo™ Lite Square er en frithængende enhed. Velegnet, når rumvolumen skal opretholdes, eller når det ikke er muligt at montere et fuldt dækkende loft.



Inpol Papier, Barde (Dolnośląskie), Poland

FORMATER

<input type="checkbox"/>	Størrelse, mm	1100x1100	1200x1200
	Speciel montage	•	•
	Tykkelse (Tk.)	40	40
	Montageanvisning	M679, M680	M679, M680

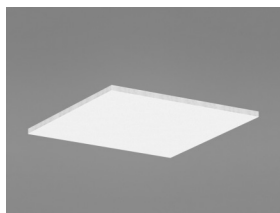

Solo Lite Square

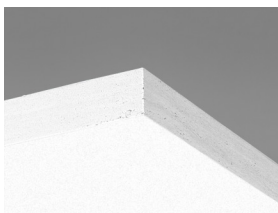

Primede kanter



Nedhængning med Connect justerbar wire og Connect absorberent-anker

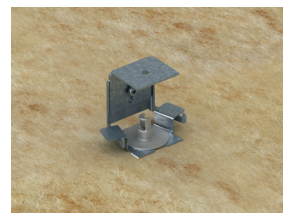

Nedhængning med Connect absorberent ophæng og Connect absorberent-anker



Akustik

Værdierne i diagrammet refererer til en enkelt enhed. Hvis enheden placeres i en klynge med afstande mellem enhederne på under 0,5 meter, bliver A_{eq} pr. enhed let reduceret.

Lydabsorption:

Testresultater i henhold til EN ISO 354.

A_{eq} ækvivalent absorptionsareal pr. enhed (m^2 sabin)

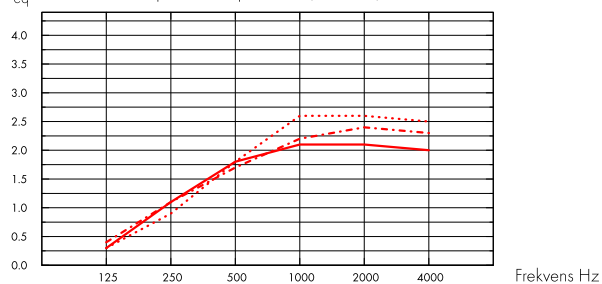

- Solo Lite 1100x1100, 200 mm o.d.s.
 - - Solo Lite 1100x1100, 400 mm o.d.s.
 - ... Solo Lite 1100x1100, 1000 mm o.d.s.
- o.d.s = tkh = total konstruktionshøjde

A_{eq} ækvivalent absorptionsareal pr. enhed (m^2 sabin)

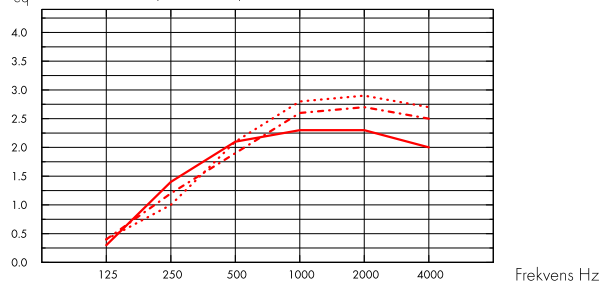

- Solo Lite 1200x1200, 200 mm o.d.s.
 - - Solo Lite 1200x1200, 400 mm o.d.s.
 - ... Solo Lite 1200x1200, 1000 mm o.d.s.
- o.d.s = tkh = total konstruktionshøjde

	Tk. mm	tkh mm	A_{eq} ækvivalent absorptionsareal pr. enhed (m^2 sabin)					
			125 Hz	250 Hz	500 Hz	1000 Hz	2000 Hz	4000 Hz
1100x1100	40	200	0.3	1.1	1.8	2.1	2.1	2.0
1100x1100	40	400	0.4	1.1	1.7	2.2	2.4	2.3
1100x1100	40	1000	0.3	0.9	1.8	2.6	2.6	2.5
1200x1200	40	200	0.3	1.4	2.1	2.3	2.3	2.0
1200x1200	40	400	0.4	1.2	1.9	2.6	2.7	2.5
1200x1200	40	1000	0.4	1.0	2.1	2.8	2.9	2.7



Indeklima

Certifikat / Label

Standard

Fransk VOC

A





Material Health



Dette produkt har modtaget et C2C Certified Material Health Certificate™ på sølv niveau (standardversion 4.0). C2C Certified Material Health Certificate™ er en verifikation af sundheden og sikkerheden af et produkts sammensætning ved hjælp af Material Health-kravene i Cradle-to-Cradle Certified Product Standard.



Circularity

Mindste indhold af genbrugsmateriale	59%
Genanvendelighed	Fuldt genanvendeligt



Brandsikkerhed

Land	Fire standard	Klasse
Europa	EN 13501-1	A2-s1,d0

Kernen af glasuld er testet og klassificeret som ikke-brændbar i henhold til EN ISO 1182.



Visuelt udseende

White Frost, nærmeste NCS-farveprøve S 0500-N, 85% lysreflektion. Glans < 1.



Rengøring

Tåler daglig støvsugning og aftørring, samt ugentlig vådaftørring med klud.



Tilgængelighed

Panelerne er demonterbare.



Montage

Monteres i henhold til montageanvisning, installationsguide og CAD-tegninger. Information vedrørende min. total konstruktionshøjde, se Mængdespecifikation.



Mekaniske egenskaber

Ingen yderligere nyttelast er tilladt.



System vægt

	kg/m ²
Solo Lite	2,5

Vægt oplysninger er vejledende og kan variere.



CE

Ecophon loftsystemer er CE-mærket i henhold til den europæiske harmoniserede standard EN 13964: 2014. CE-mærkede byggevarer er omfattet af en DOP (Declaration of Performance), som gør det muligt for kunder og brugere at sammenligne de tilgængelige produkter på det europæiske marked.

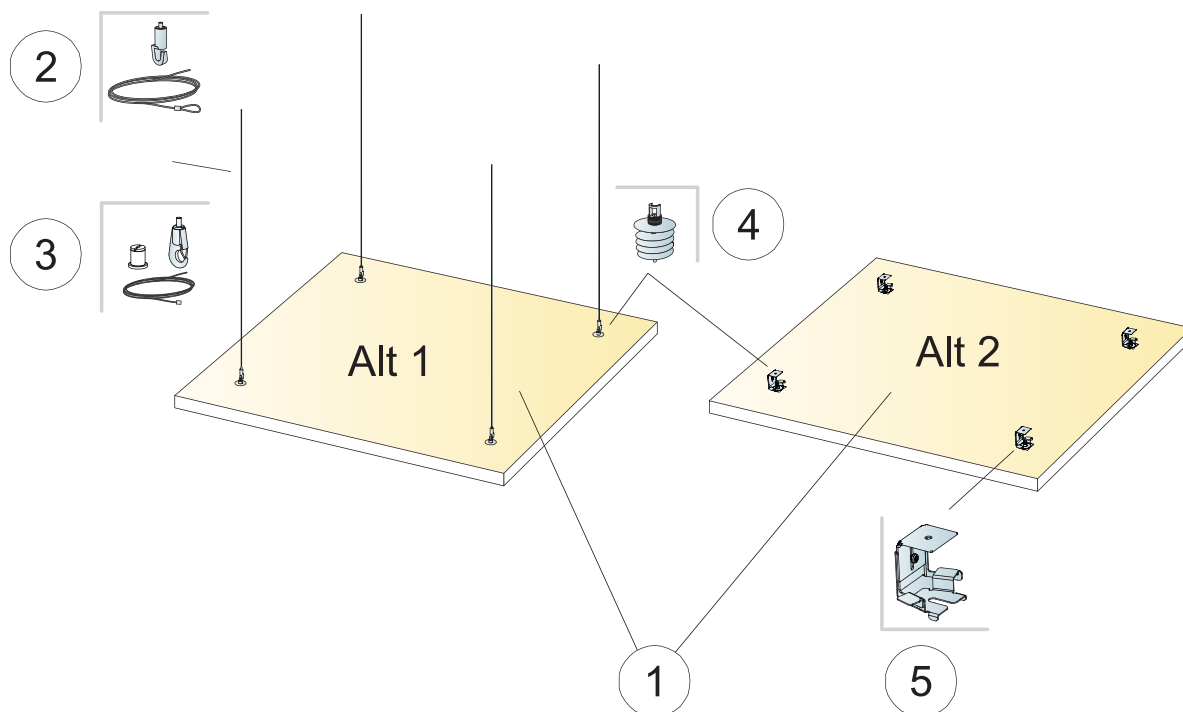

MÆNGDESPECIFIKATION (EKSKLUSIV SPILD)

	Størrelse, mm	
	1100x1100	1200x1200
1 Solo Lite Square	1,21m ² /panel	1,44m ² /panel
2 Connect justerbar wire (Alt 1)	4/panel	4/panel
3 Connect justerbar wiresæt (Alt. 1, Valgfri)	4/panel	4/panel
4 Connect absorbt anker	4/panel	4/panel
5 Connect absorbt ophæng (Alt. 2)	4/panel	4/panel
Δ Min. total konstruktionshøjde: Δ1 130 mm / Δ2 90 mm	-	-

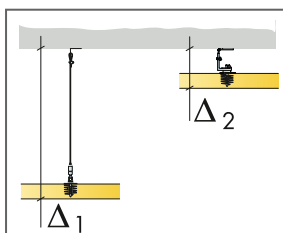

Se materialespecifikation

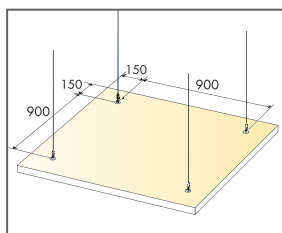

Installation dimensions 1200 x 1200

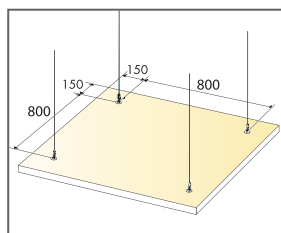

Installation dimensions 1100 x 1100

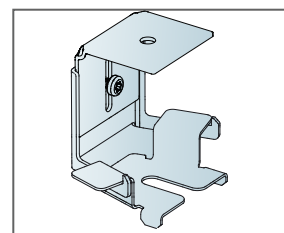

Absorbt ophæng. Total konstruktionshøjde 90-130 mm.

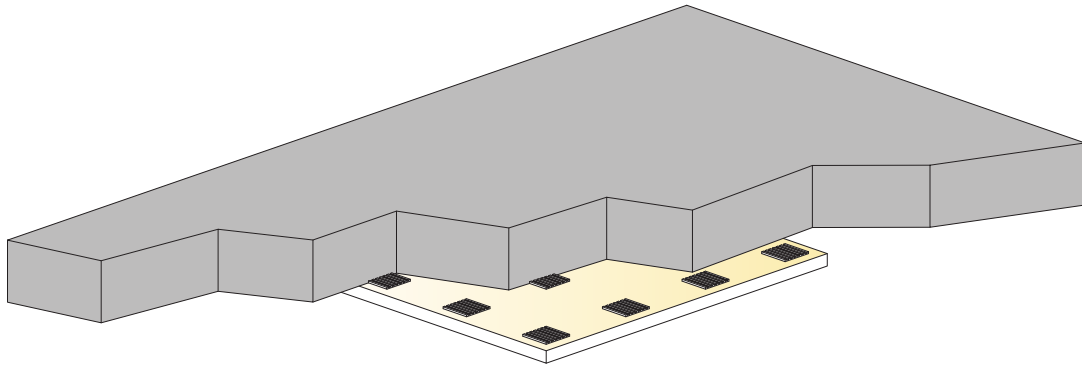

MÆNGDESPECIFIKATION (EKSKLUSIV SPILD)

	Størrelse, mm	
	1100x1100	1200x1200
1 Solo Lite Square	1,21 m ² /panel	1,44 m ² /panel
2 Connect absorberlim (0,25 l/m ² - 0,4 l/m ² afhængig af montageforhold)	efter opmåling	
Synlige skårne kanter skal males	-	-
Δ Min. total konstruktionshøjde: 43 mm	-	-
Anvend Connect tandspartel ved påføring af lim.	-	-
δ Systemet er ikke demonterbart	-	-

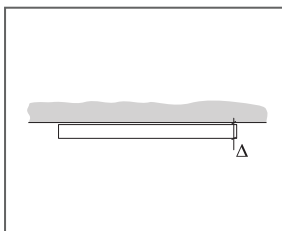

Se mængdespecifikation

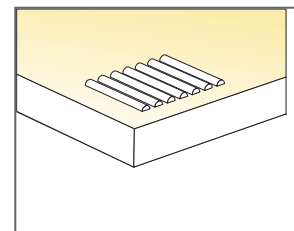

Påføring af lim